

# New Developments in LS-DYNA®

Part II

LS-DYNA Users Conference

J.O. Hallquist

October 2, 2008



43

## Outline of talk

- Part I
  - Introduction
  - LSTC dummy/barrier developments
  - Version 980
  - New features in version 971 release 3
- Part II
  - New features in version 971 release 4
  - Conclusions



44

## Version 971\_R4 and future developments



45

## Bulk viscosity for beams

- Bulk viscosity is now optional for the Hughes-Liu beam and beam type 11 with warpage.
- Provides better stability especially in elastic response problems.
- Options:
  - The bulk viscosity is turned off for beams.
  - The bulk viscosity is turned on for beams and its energy contribution is not included in the overall energy balance.
  - The bulk viscosity is turned on for beams and its energy contribution is included in the overall energy balance.



46

## \*Define\_function

- Arithmetic expression involving a combination of independent variables and other functions, i.e.,
  - $f(a,b,c)=a^2+b*c+\text{sqrt}(a*c)$where a, b, and c are the independent variables.
- The function name, f(a,b,c), must be unique since other functions can then use and reference this function.
  - $g(a,b,c,d)=f(a,b,c)**2+d$ .



47

## \*Define\_function

- Implemented for a subset of keywords
  - \*ELEMENT\_SEATBELT\_SLIPRING
  - \*LOAD\_BEAM
  - \*LOAD\_MOTION\_NODE
  - \*LOAD\_MOVING\_PRESSURE
  - \*LOAD\_NODE
  - \*LOAD\_SEGMENT
  - \*LOAD\_SEGMENT\_NONUNIFORM
  - \*LOAD\_SEGMENT\_SET\_NONUNIFORM
  - \*BOUNDARY\_PRESCRIBED\_MOTION
- No change in input is required. If a curve ID is not found, then the function ID's are checked



48

## \*Database\_extent\_binary

- Until now only one set of integration points were output through the shell thickness.
  - Lamina stresses and history variables were averaged for fully integrated shell elements.
    - Results in less disk space for the D3PLOT family of files, but it is difficult to verify accuracy of stress calculation after averaging
- Option is now available to output all integration point stresses in fully integrated shell elements
  - 4 x # of through thickness integration points in shell types 6, 7, 16, 18-21.
  - 3 x # of through thickness integration points in triangular shell types 3, and 17



LSTC  
Livermore Software  
Technology Corp.

49

## \*Database\_extent\_binary

- Parameters INTOUT, NODOUT cause a detailed version of the ascii/binary ELOUT file to be written with a new filename ELOUTDET. The suffix, DET, means detailed.
- INTOUT causes all integration points to be output.
- NODOUT is a request for nodal output extrapolated from the integration points.
  - Nodal output when NODOUT=STRESS, STRAIN, or ALL. Each node of the element nodal connectivity will be output with data output in the local system of the element.
  - Nodal output when NODOUT=STRESS\_GL, STRAIN\_GL, or ALL\_GL. Averaged nodal results are calculated by summing up all contributions from elements sharing the common node, and then dividing the total by the number of contributing elements. Averaged nodal values are always output in the global coordinate system.



LSTC  
Livermore Software  
Technology Corp.

50

## User material and user eos

- In version R4 it has become possible to combine user material models with user equations-of-state (eos).
  - Implemented for 3D solid elements
  - The user material ID and user eos ID are referenced on the part card and there are no special requirements.



51

## Improvements to solids type 3/4

- Solid elements with rotational degrees-of-freedom include the type 3 brick and type 4 tetrahedron:
- These elements are now extended to treat large strains and rotations.

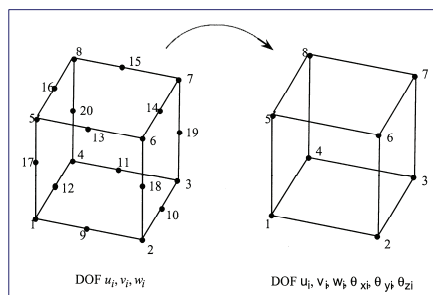

52

## \*Define\_spotweld\_ruption\_stress

- Developed for beam elements by Toyota Motor Corporation
- Option is now available for solid elements and spotweld made from solid element spotweld clusters
- With this keyword a table containing the experimental data is defined where
  - Rupture stress values are defined by part ID
- In \*MAT\_SPOTWELD this option is activated by setting the parameter *OPT* to a value of 6



53

## \*Define\_spotweld\_ruption\_stress

- The failure model is based on peak stress determined from beam theory
- The failure criteria includes rate effects:

$$\left( \frac{\sigma_{rr}}{\sigma_{rr}^F(\dot{\epsilon}^p)} \right)^2 + \left( \frac{\tau}{\tau^F(\dot{\epsilon}^p)} \right)^2 - 1 = 0$$

- Where the rupture stresses are found by using the Cowper and Symonds model which scales the static failure stresses:

$$\sigma_{rr}^F(\dot{\epsilon}^p) = \sigma_{rr}^F \cdot \left[ 1 + \left( \frac{\dot{\epsilon}^p}{C} \right)^{1/p} \right] \quad \tau^F(\dot{\epsilon}^p) = \tau^F \cdot \left[ 1 + \left( \frac{\dot{\epsilon}^p}{C} \right)^{1/p} \right]$$



54

## \*Define\_spotweld\_ruption\_stress

- The average plastic strain rate is integrated over the domain of the attached shell element.
- The constants  $C$  and  $p$  are taken from the constitutive data of the attached shell elements.
- The failure criteria is computed independently for each surface of the cluster. If failure occurs on either surface, the spotweld fails

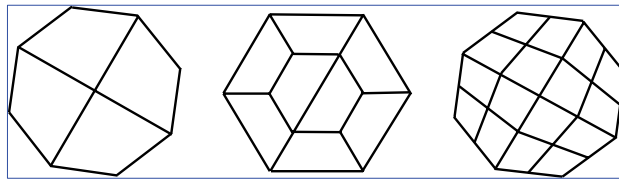

55

## \*Control\_spotweld

- Failure is sensitive to the:
  - location of the spotweld on the contact segment
  - physical size of the segment
- This control card provides a means of scaling the failure force resultants to compensate for these sensitivities
- This option now works for solid/solid cluster welds if OPT=6.

$$\left( \frac{S_T S_O \sigma_{rr}}{\sigma_{rr}^F (\dot{\epsilon}_{eff})} \right)^2 + \left( \frac{S_S S_O \tau}{\tau^F (\dot{\epsilon}_{eff})} \right)^2 - 1 = 0$$



56

## \*Control\_spotweld

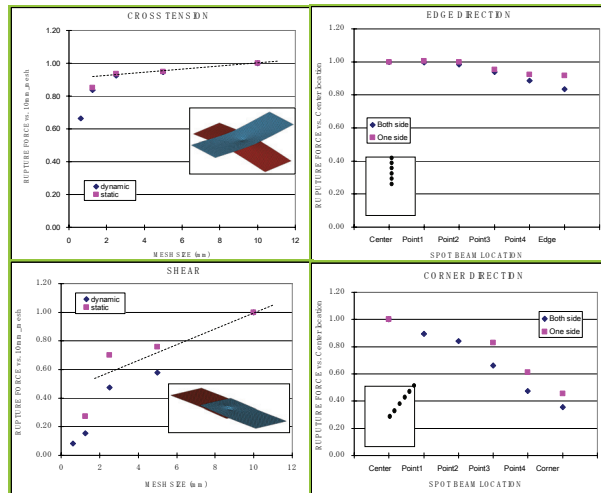

57

## \*Define\_element\_death

- New keyword to delete an element or an element set at a specified time. Available options include:
  - SOLID
  - SOLID\_SET
  - BEAM
  - BEAM\_SET
  - SHELL
  - SHELL\_SET
  - THICK\_SHELL
  - THICK\_SHELL\_SET



58



## \*Element\_mass\_matrix

- Define a 6x6 symmetric nodal mass matrix assigned to a nodal point or each node within a node set
- Local coordinate ID can be input, which defines the orientation of the mass matrix
- Rotation of the local system during the simulation is taken into account
- The lower triangular matrix is defined in the input.



59

## \*Element\_seatbelt\_slipping

Frictional sliding of belt over slipping can now be specified as a function of two angles.

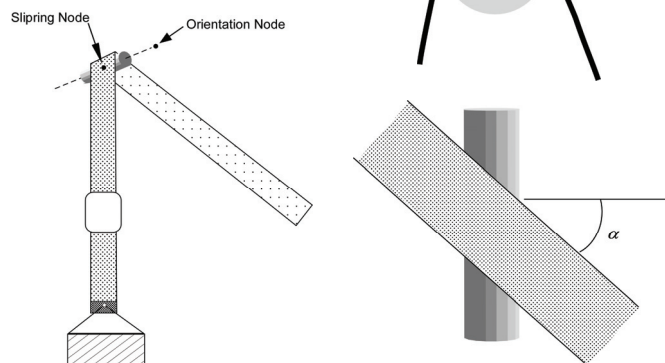

60

## Superplastic Forming

- Strain rate speed-up
  - In order to speed up the simulation of superplastic forming process, we scale down the computation time. By doing this we increase the strain rate allowed in the SPF process, resulting in reduced simulation time.
  - Two user input parameters are required in \*LOAD\_SUPERPLASTIC\_FORMING
    - TFACT, speed-up factor
    - NTFCT, number of cycles to ramp up



61

## Numerical Example

### Deep Draw

Superplastic Forming Simulation

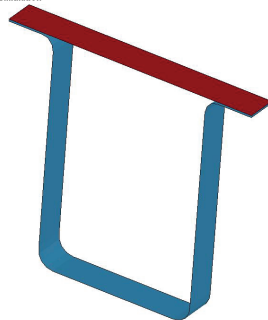

Simulation Model

Options	Cycles	Normalized CPU
No Speedup	<b>148746</b>	<b>1.000</b>
5x	<b>30070</b>	<b>0.146</b>
10x	<b>16101</b>	<b>0.079</b>

Computational Costs



62

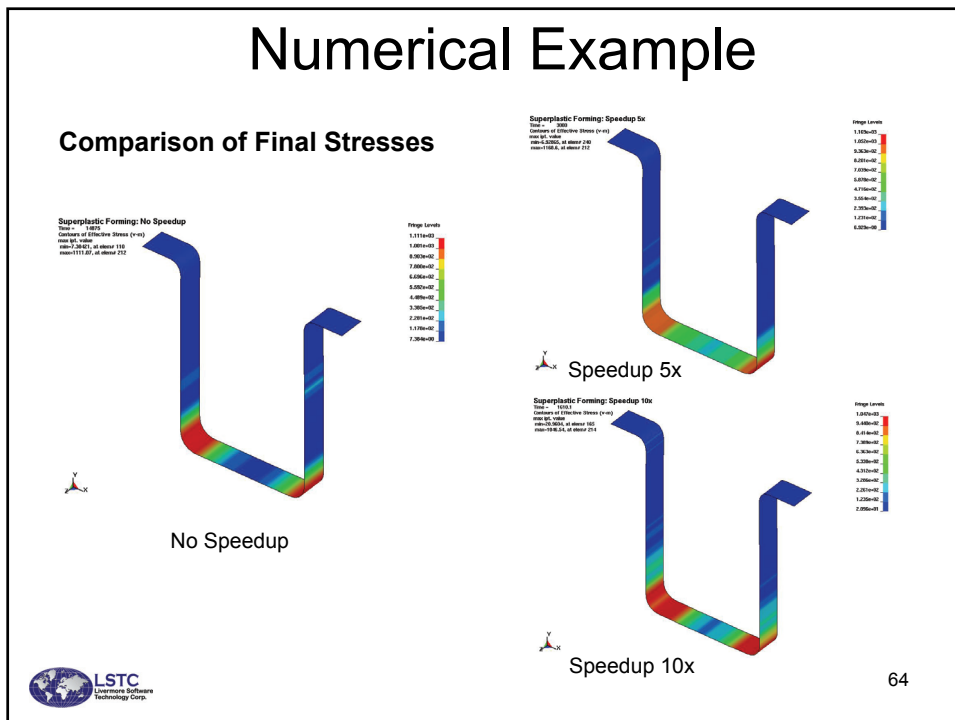
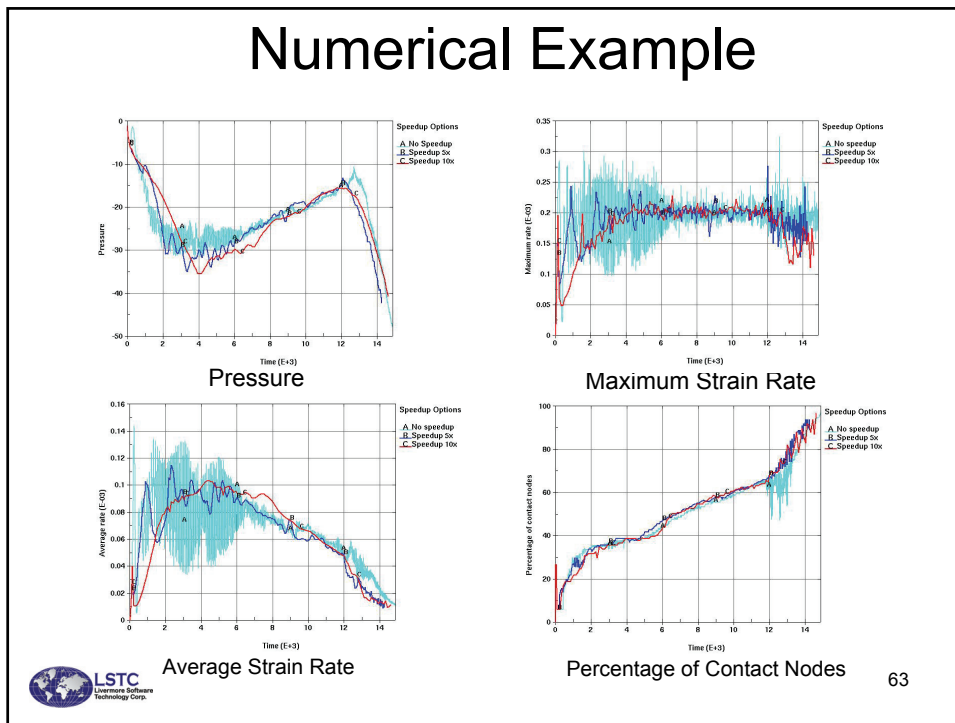

## Implicit binder wrap

- Improvements to the stability of the implicit contact now allow difficult binderwrap problems to be computed in a single implicit step.

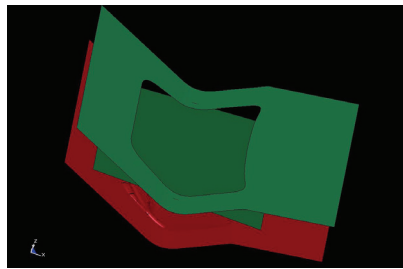

Initial geometry

Final geometry after 1 step

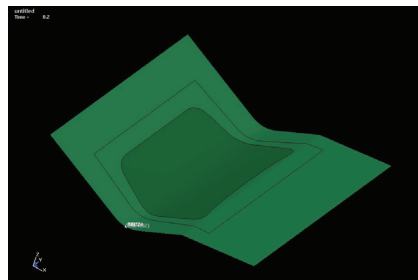

65



## Implicit gravity & binder wrap

- Combined gravity and binder wrapping is now possible for the first time in LS-Dyna

Initial geometry

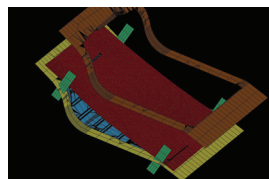
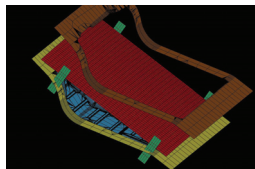

After uniform refinement

Final shape with buckling mode

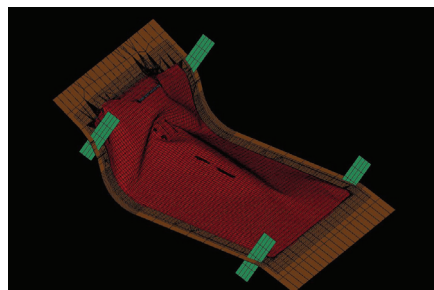

66



## \*Load\_segment\_set\_angle

- Apply the traction load over a segment set that is dependent on the orientation of a vector
  - pressure on a piston head as a function of the crank angle

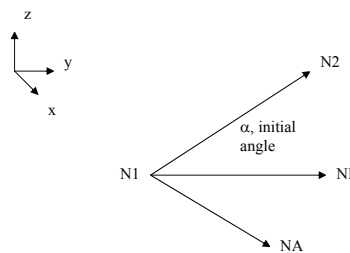

67

## \*Load\_segment\_set\_angle

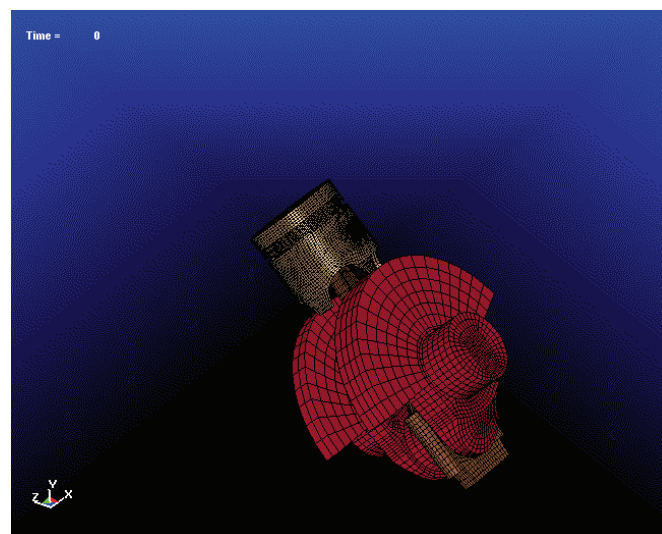

68

## \*Control\_implicit\_onestep

- A new feature has been implemented to provide one-step solution
  - Can provide initial guess of the blank size
  - Can also provide rough guess of the formability
    - Mat\_037 through thickness anisotropic
- Example



69

## Hood-inner example

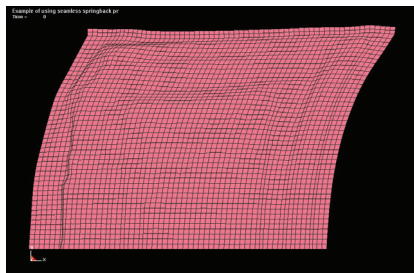

Initial guess

Information:  
Element #: 3024  
CPU: 62 seconds

Final Mesh

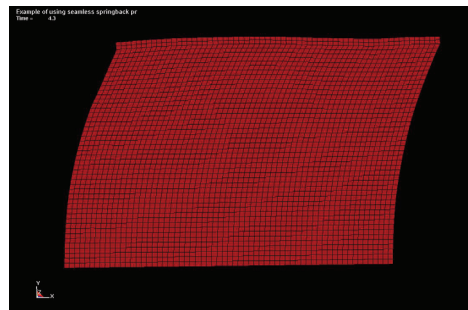

70

## Hood-inner example

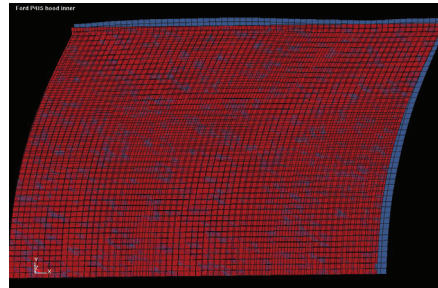

Comparisons:

Red: real initial blank size

blue: predicted initial size

Observations: predicted blank size is a little larger

Explanations: no drawbead is used for the one-step.

In the future drawbead and friction will be supported



71

## Recent EFG developments

- Implicit implementation for 3D continuum solids
  - With adaptive remeshing
- MPP implementation
  - Implicit/explicit
    - Including adaptivity
  - Excellent scalability



72

## Implicit extrusion simulation

(Courtesy of JRI)

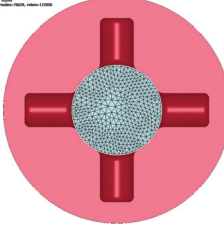

Initial Mesh

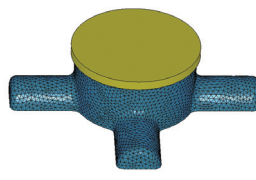

LS-DYNA user input

\*MAT\_POWER\_LAW\_PLASTICITY  
\*CONTACT\_SURFACE\_SURFACE  
\*SECTION\_SOLID\_EFG

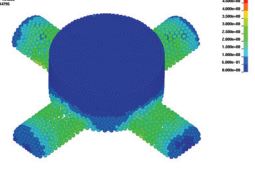

Final Plastic Strain



73

## Extrusion simulation

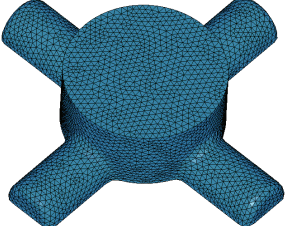
(Implicit and Explicit)

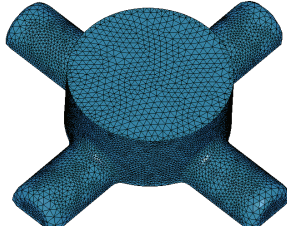

Global Refinement



Local Refinement

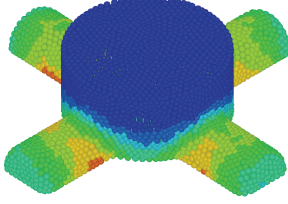

Final Plastic Strain

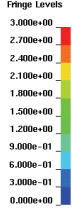

Fringe Levels

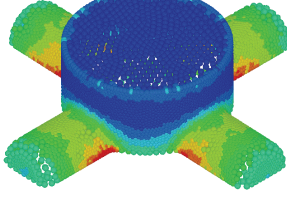

Final Plastic Strain



74

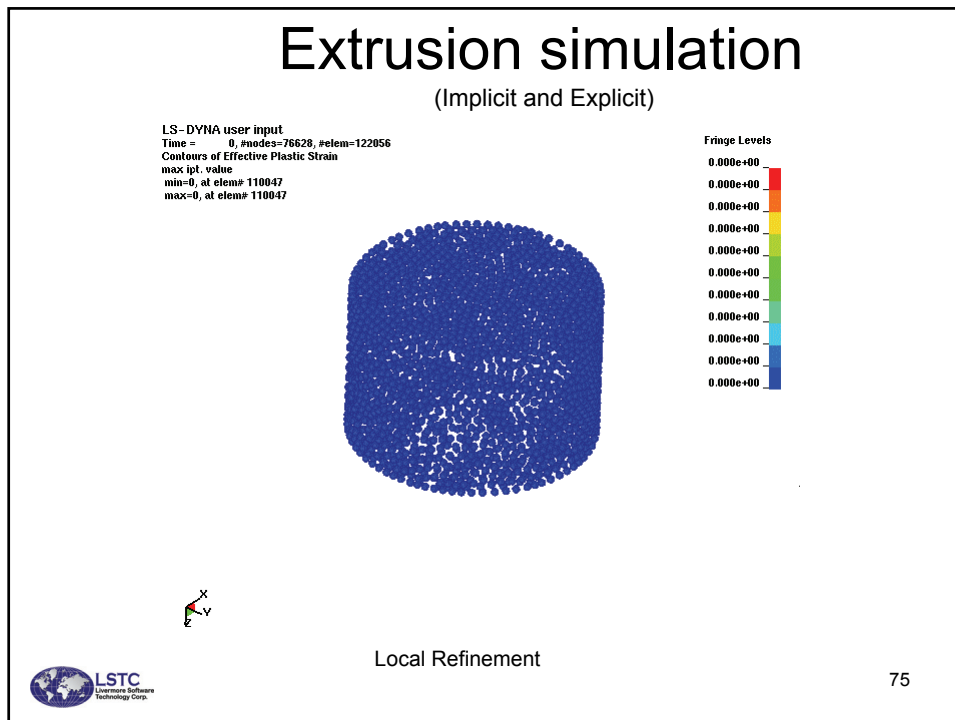



## Mesh free shells

- Adaptive remeshing is implemented for both SMP and MPP
- \*MAT\_ADD\_EROSION is implemented
- CPU cost on example forming problem are higher
  - Type 2 - 13.25 minutes
  - Type 16 - 21.41 minutes
  - Type 26 - 31.05 minutes
  - Type 42 - 41.26 minutes
  - (Mesh Free)

 LSTC  
Livermore Software  
Technology Corp.

## Mesh free shells

- Based on the mesh-free surface representation and the mesh-free shell formulation
  - First-order shear deformable shell theory is adopted
  - An assumed strain method is utilized
- Works well for the membrane and bending-dominant problems with highly irregular meshes
- Full car crash models from NCAC with 100% EFG shells have reached normal termination



77

## Explicit mesh-free shell

Alumi 8kaku Ctr=6mm  
Time = 0

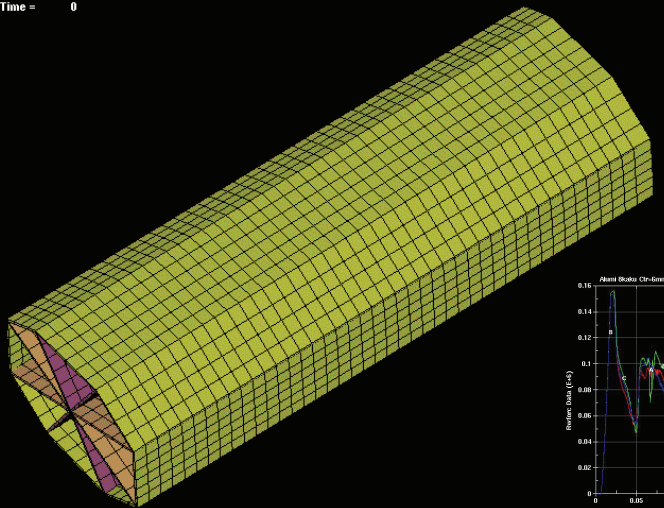

Timings (sec)  
EFG 12480  
Type 16 6360  
Type 2 1680

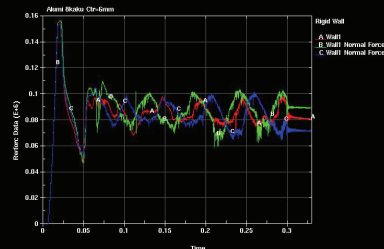

78

## \*BOUNDARY\_PRESCRIBED\_ORIENTATION\_RIGID\_OPTION

- Allows the orientation of a rigid body to be prescribed as a function of time.
- Uses a total formulation which is more precise than the incrementally based:  
\*BOUNDARY\_PRESCRIBED\_MOTION\_RIGID
- Options:
  - \_ANGLES: Specify a sequence of rotations about either body or space fixed axes and the associated orientation angles  $q_i(t)$  ( $i=1,2,3$ ) as time histories using \*DEFINE\_CURVE.
  - \_DIRCOS: Nine elements of the direction cosine matrix are input as functions of time,  $C_{ij}(t)$  ( $i,j=1,2,3$ )
  - \_EULERP: Provide as functions of time four Euler parameters,  $\varepsilon_i(t)$  ( $i=1,\dots,4$ )



79

## Roller hemming process

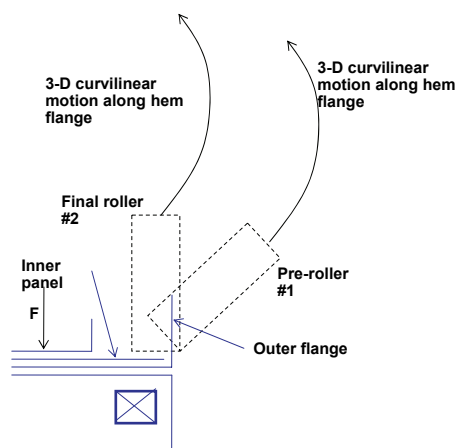

80

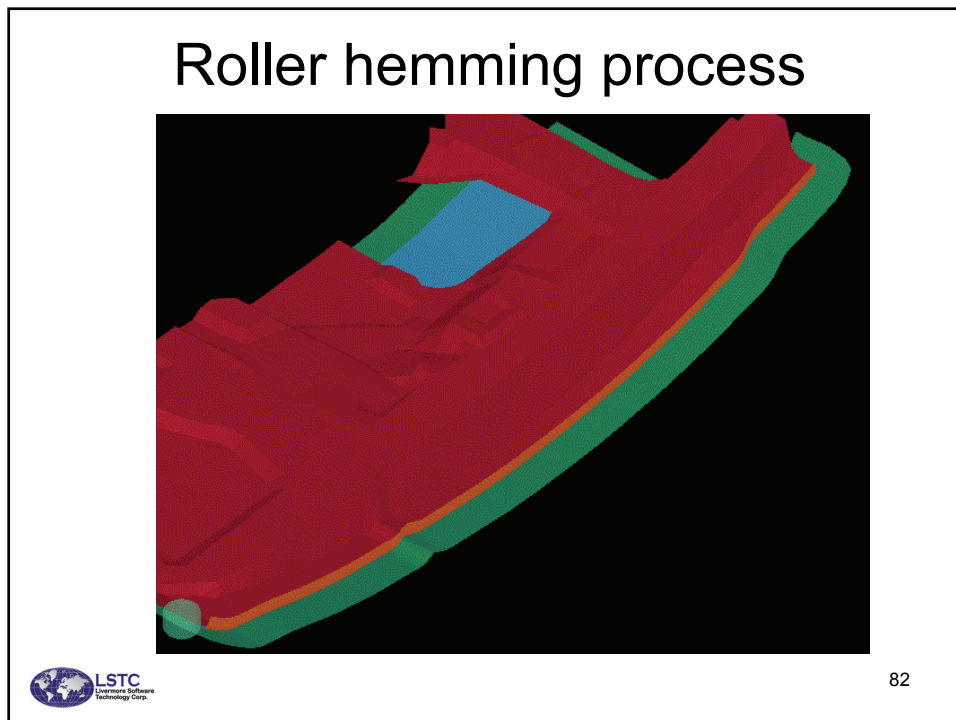
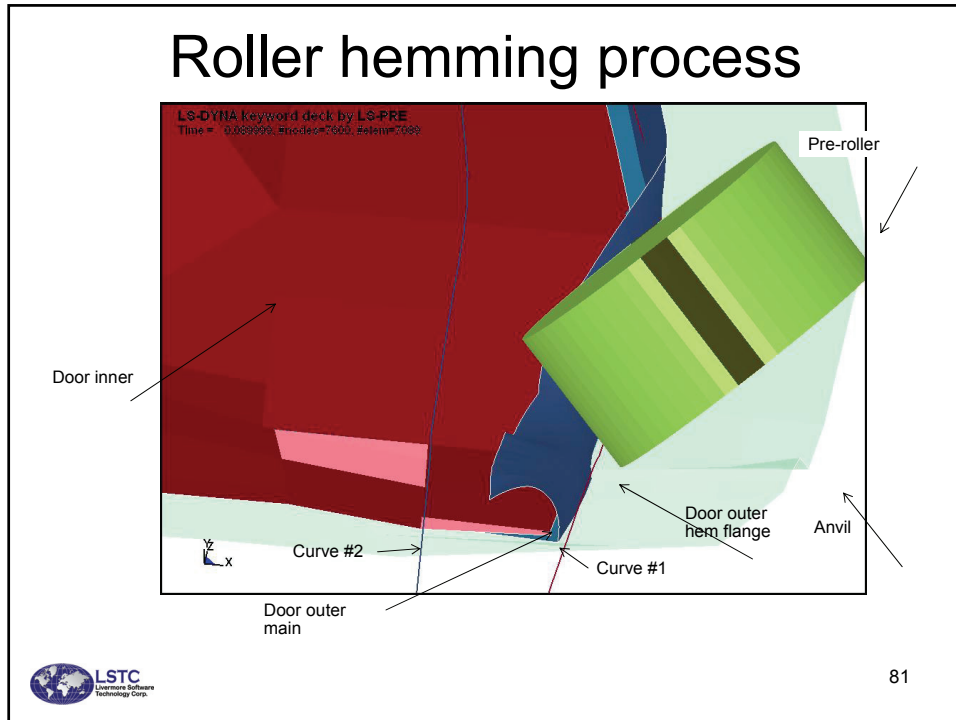

## Roller hemming process

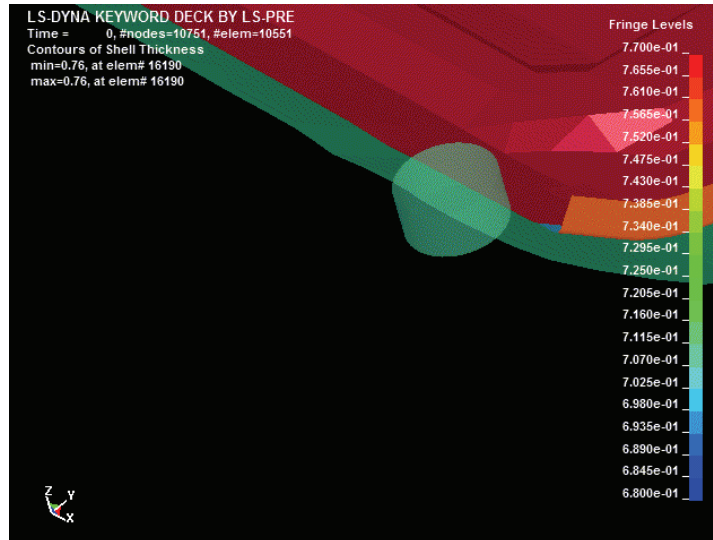

83

## Seismic Soil-Structure Interaction

- Transient SSI analysis with non-linear structure has two key issues:
  - Modeling of unbounded soil or rock
  - Input of earthquake ground motion
- LS-DYNA current practice:

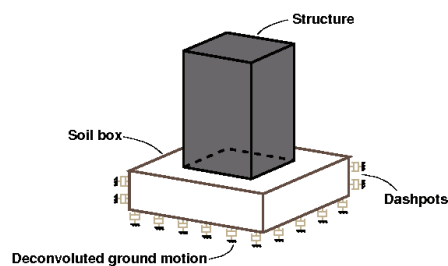

84

## Seismic Soil-Structure Interaction

### Problems:

- Viscous dashpots do not absorb all waves well
  - Large domains are needed for accuracy
- Deconvolution gives incorrect spatial variation of ground motion at soil-structure interface
- Applying ground motions at base of soil box is heuristic with little rational basis
  - Current approach employed by LS-Dyna users



85

## Seismic Soil-Structure Interaction

- LS-DYNA now provides a new alternative approach that is more rational and accurate
- Perfectly Matched Layers (PML) are used to model the unbounded domain
  - [Basu-Chopra (2003,2004), Basu (2008)]
- PML is an absorbing layer model:
  - 5 to 10 elements deep, close to the structure,
  - Absorbs all outgoing waves from the structure
- PML is accurate, inexpensive, and robust



86

## Seismic Soil-Structure Interaction

- Free-field ground motions are specified at the soil-structure interface to compute effective forces which provide the ground motion input at the base of the structure
  - [Effective seismic input method: Bielak et al.]

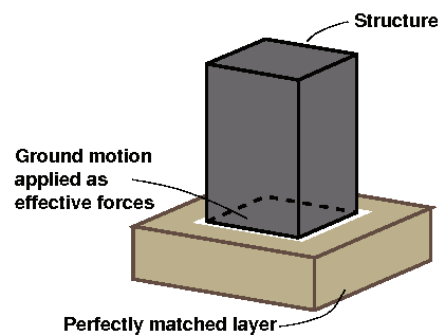

87

## Seismic Soil-Structure Interaction

- No deconvolution is necessary — just use the site-specific free-field ground motion provided by seismologists
- The technique can handle embedded structures
- Has been extended to dams, where both the rock and the reservoir are unbounded



88

## \*Control\_implicit\_consistent\_mass

- Available for 8-node solid, 10-node tetra, and 3- & 4-node shells.
- Implemented for:
  - Eigenvalues
  - Implicit dynamics
  - Body force loads
- Improves accuracy at low frequencies.
- Consistent mass matrix has the same profile as the stiffness matrix therefore it is not yet available for explicit dynamics.



89

## User-Defined Elements

- Implemented for solids and shells.
- Permits new element types to be defined entirely by keyword input.
- Interpolation elements allow output to LS-PREPOST.
- Intended for researchers and students.
  - Research: isogeometric elements.
  - Students: implement elements as homework.
- Analysis types:
  - Explicit, Implicit quasi-static and dynamic



90



## Isogeometric Analysis

### *Example of User-Defined Elements*

- Isogeometric analysis uses NURBS as basis functions.
- NURBS are the basis functions used in CAD programs.
- Therefore: facilitates direct CAD to analysis interface.
- NURBS are nicely behaved.
  - Improved numerical conditioning.
  - Larger time step size for higher order elements than for Lagrangian polynomials.



91

## Shell Formulations

- 3 types currently available.
- IFORM=0: Degenerated solid element with rotational DOF.
  - $$v_i(\xi) = \sum_{A=1}^n N_A(\xi) \left( v_{Ai} + \frac{h\xi_3}{2} e_{ijk} \omega_{Aj} n_k \right)$$
- IFORM=2: Thin shell without rotational DOF.
  - $$v_i(\xi) = \sum_{A=1}^n N_A(\xi) v_{Ai} + \frac{h\xi_3}{2} \sum_{B,k} \frac{\partial n_i(\xi)}{\partial x_{Bk}} v_{Bk}$$
- IFORM=3: Reissner-Mindlin with rotational DOF.

- $$v_i(\xi) = \sum_{A=1}^n N_A(\xi) \left( v_{Ai} + \frac{h\xi_3}{2} e_{ijk} \omega_{Aj} n_k(\xi) \right)$$



92

## Implementation in LS-DYNA

- User-defined element capability:
  - Fast prototyping of elements without programming.
  - Available for both solids and shells.
  - Executes slower than production elements.
- Some boundary conditions implemented via interpolation elements.
  - Contact doesn't have underlying smoothness of NURBS.
  - Pressure distribution is not exactly integrated.



93

## Square tube buckling

*Quadratic (P=2) and Quartic (P=4) NURBS Elements*

- Isogeometric NURBS basis functions
  - Quadratic ( $s^2$ ) and quartic ( $s^4$ ) functions
  - 3 integration points through the thickness
- 858 control points (nodes)
- 640 quadratic elements
- Perturbation of control points (nodes) with amplitude of 0.05 at  $y=67.5$
- \*MAT\_KINEMATIC\_PLASTIC with isotropic hardening



94

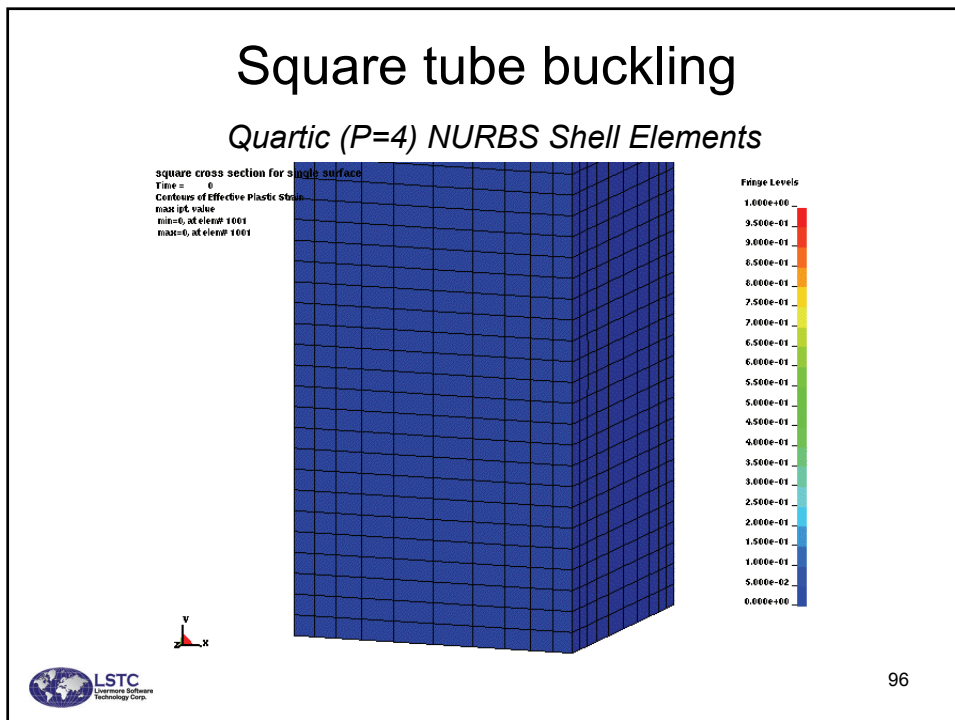
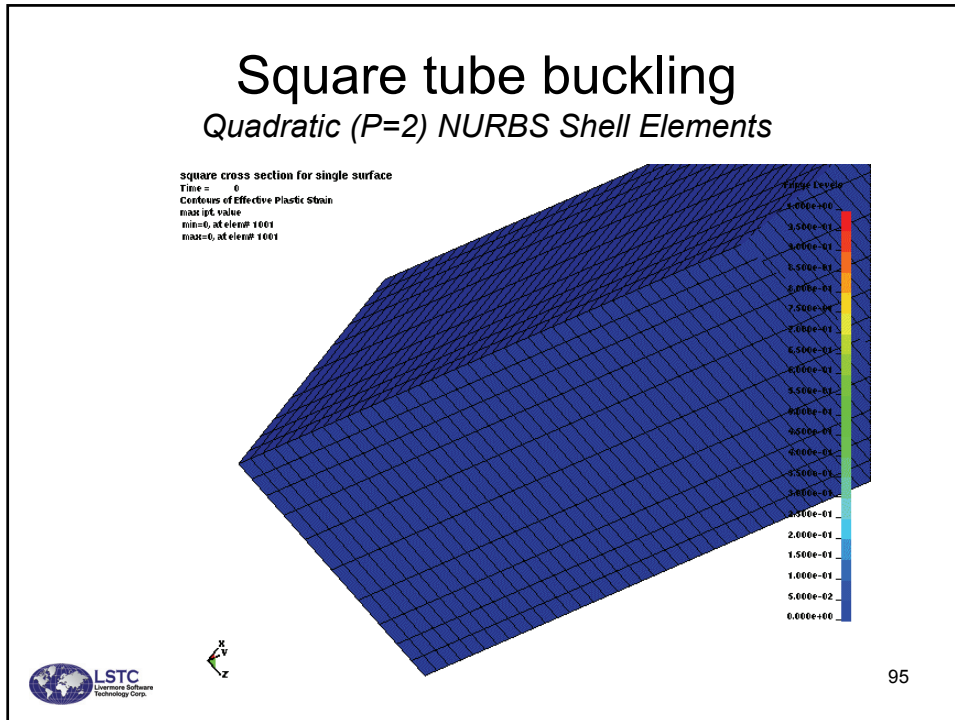

## Goal: CAD to analysis

- Isogeometric elements available in LS-DYNA via user-defined elements. 100% keyword input, i.e., no programming required.
  - Explicit.
  - Implicit.
  - Eigenvalue analysis.
- Preliminary results suggest that:
  - Higher order accuracy without dt penalty of Lagrangian shape functions.
  - Excellent eigenvalue accuracy.
  - Shell elements without rotational DOF show promise.
  - Robust large deformation performance.



97

## \*Constrained\_self\_piercing\_rivet

Based on research carried out by SIMLab (NTNU) and SINTEF

Rivet translation and rotation follow the motion of the master sheet.

Tear out from the top sheet may occur if this sheet is thinner or weaker than the bottom sheet.

A damage model is used to model the reduction in strength prior to failure

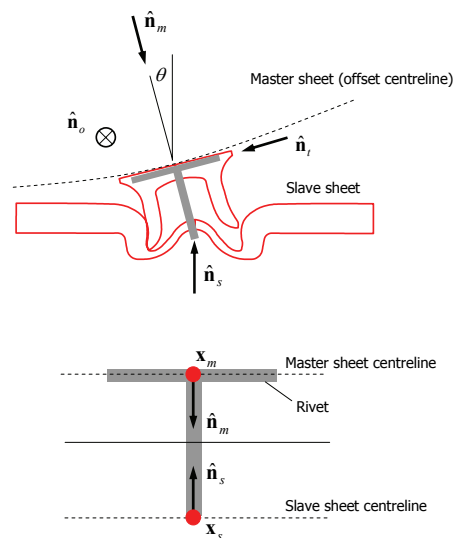

98

## \*Constrained\_self\_piercing\_rivet

The domain of influence is specified by a diameter

The location of the rivet is defined by a set of rivet nodes.

The forces are lumped to the nodes within the radius of domain using an interpolation function

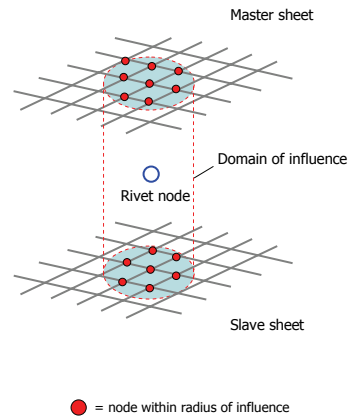

99

## \*Constrained\_self\_piercing\_rivet

Identified parameters:

$f_{r0}$	$f_{r10}$	$\delta_{fail}$	$\alpha_1$	$\alpha_2$	$\alpha_3$
3660 N	7000 N	7.05 mm	0.8	5.0	1.64

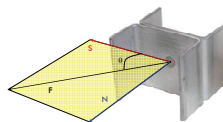
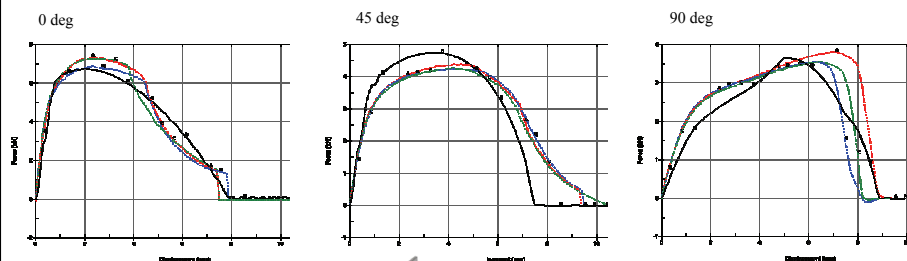

100

## Steady State Rolling

- \*LOAD\_STEADY\_STATE\_ROLLING  
define the tire rotation and cornering angular velocity, the translation velocity.
- \*CONTROL\_STEADY\_STATE\_ROLLING  
define a curve of the scale factors for friction coefficients.

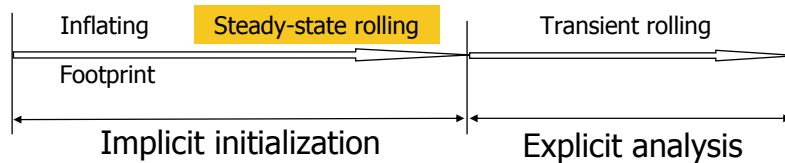
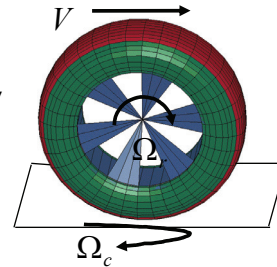

G. Hu, P. Wriggers, "On the adaptive finite element method of steady-state rolling contact for hyperelasticity in finite deformations", CMAME, 2002, 191, 1333-1348.  
 Oden, J. T., T. L. Lin, "On the general rolling contact problem for finite deformations of viscoelastic cylinder", CMAME, 1986, 57, 297-3677.



101

## \*Initial\_axial\_force\_beam

- Beam axial forces can now be initialized to allow a simplified method to model initial tensile force in bolts.
- Works with \*MAT\_SPOTWELD and beam type 9. Failure of bolts are based on the force resultants as in the spotwelds
- Load curves are used to initialize forces
- Required input requires beam set ID and a corresponding load curve ID



102

## \*Mat\_add\_erosion: background

- Many of the constitutive models in LS-DYNA do not include failure and erosion.
- The MAT\_ADD\_EROSION option provides a way of including failure in these models in **one point solid elements**
- The option can also be applied to constitutive models with other failure/erosion criterion.
- Each of the failure options are applied independently, and once any one of them is satisfied, the element is deleted from the calculation.



103

## \*Mat\_add\_erosion: extended

- Can now be applied to all nonlinear shell, thick shell, and fully integrated solids
- Element deletion occurs after  $n$  integration points have failed  $m$  failure criteria
  - $n$  and  $m$  are an input parameters (default=1)
- New failure criteria based on volumetric and distortional strain are available
- Can be applied in metalforming simulations with adaptive remeshing



104

## Modeling elastic die structures

- Modeling of elastic die structures in the stamping process
  - Durability of die
  - Deflection effects on stamping
- Static condensation to create die superelements
  - All surface nodes are kept and internal degrees-of-freedom are eliminated
  - Keyword:  
\*CONTROL\_IMPLICIT\_STATIC\_CONDENSATION
  - Equations for die motion are integrated explicitly
  - Stress recovery for durability analysis
- Two options
  - Create superelements prior to analysis
  - Define an elastic part set in LS-Dyna input



105

## Explicit constraint equations

- Historically, LS-DYNA **Explicit** applies constraints each time step by constraint type; therefore, a given node should not be subject to multiple constraints.
- However, LS-DYNA **Implicit** uses a global view of constraints and constructs a constraint matrix so multiple constraints are consistently applied.
- With the **Consistent Constraint Explicit** option, CCE, which is under development, we apply this Implicit technology to explicit problems



106



## Consistent constraint explicit

- Implementation:
  - Build a global constraint matrix C and associated right hand side g.

$$\begin{array}{l} \text{Solve} \quad Ma = f \\ \text{Subject to} \quad Ca = g \end{array}$$

- A critical issue is the efficient solution of the constrained linear system



107

## CCE status

- After 1+ years the implementation now includes:

Adaptive	Joints
Beam Release	Nodal Constraints
Boundary SPC	Point Constraints
Constrained Linear	Prescribed Motion
Cyclic Boundary	Rigid Bodies
Discrete Beam Joints	Tied Contact



108

## CCE summary

- A new approach for explicit time integration
- Currently working on many examples, but running too slow
- Allows identical constraint treatment for NVH, durability, and crash models
- Future success will depend on the development of a highly efficient and scalable solver



109

## 2D to 3D mapping

A 2D version of the ALE code was developed :

- Plane strain
- Surface weighted axisymmetric

The main reason of these developments is the mapping.

If some parts of a problem can be solved in 2D, it will save time to do the following:

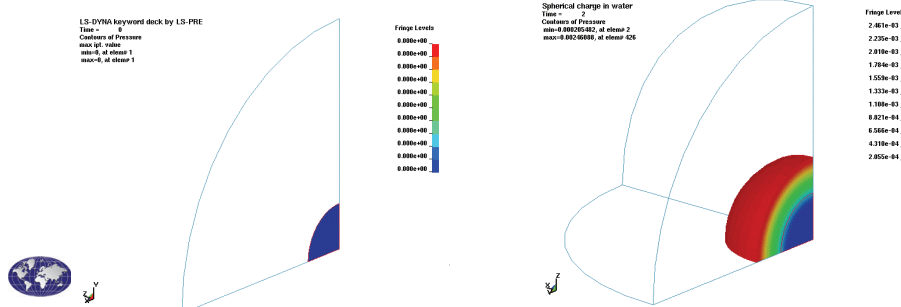
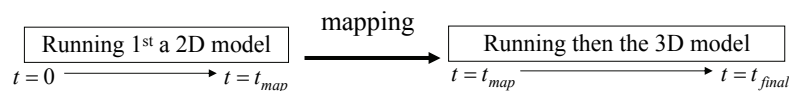

## Theory basis for BEM acoustics

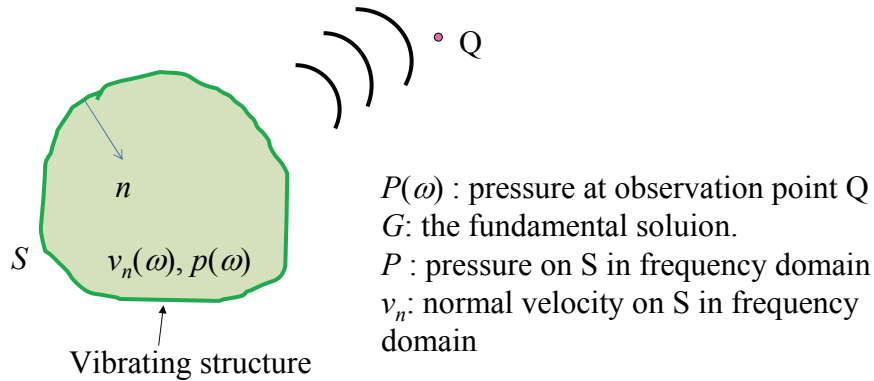

Helmholtz integral equation

$$P(\omega) = - \int_S \left( i \rho \omega v_n(\omega) G + p(\omega) \frac{\partial G}{\partial n} \right) ds$$



111  
111

## Acoustic solvers in LS-DYNA

### BEM (accurate)

- Indirect variational boundary element method
- Collocation boundary element method

*A fast solver is available*

*MPP version is available*

### Approximate methods

- Rayleigh method
  - Kirchhoff method
- Assumptions and simplification in formulation*  
*Very fast since no equation system to solve*



112

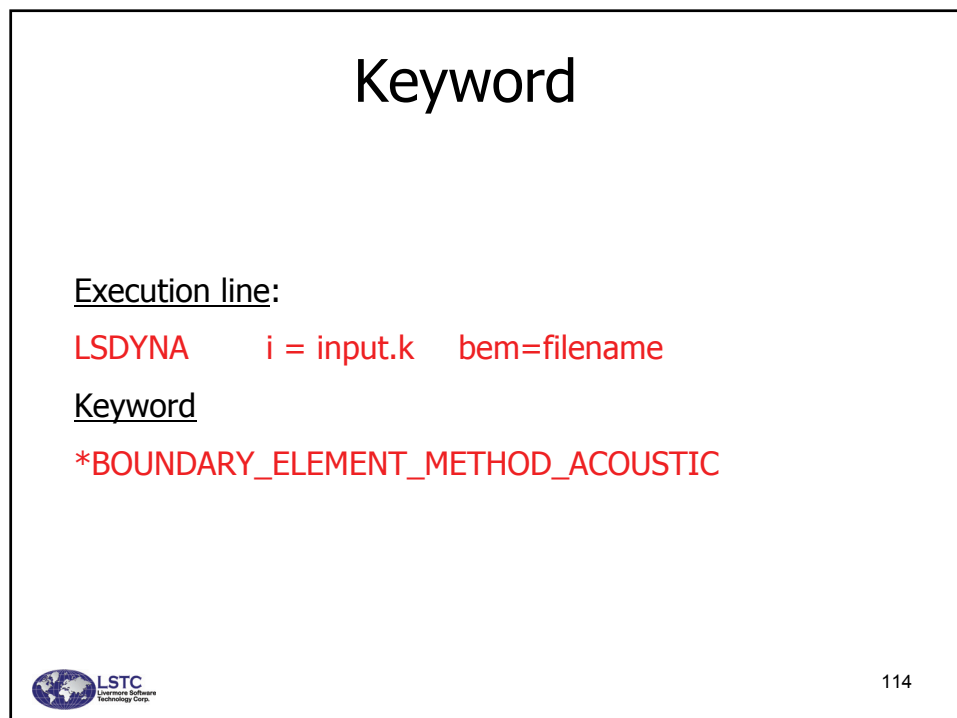
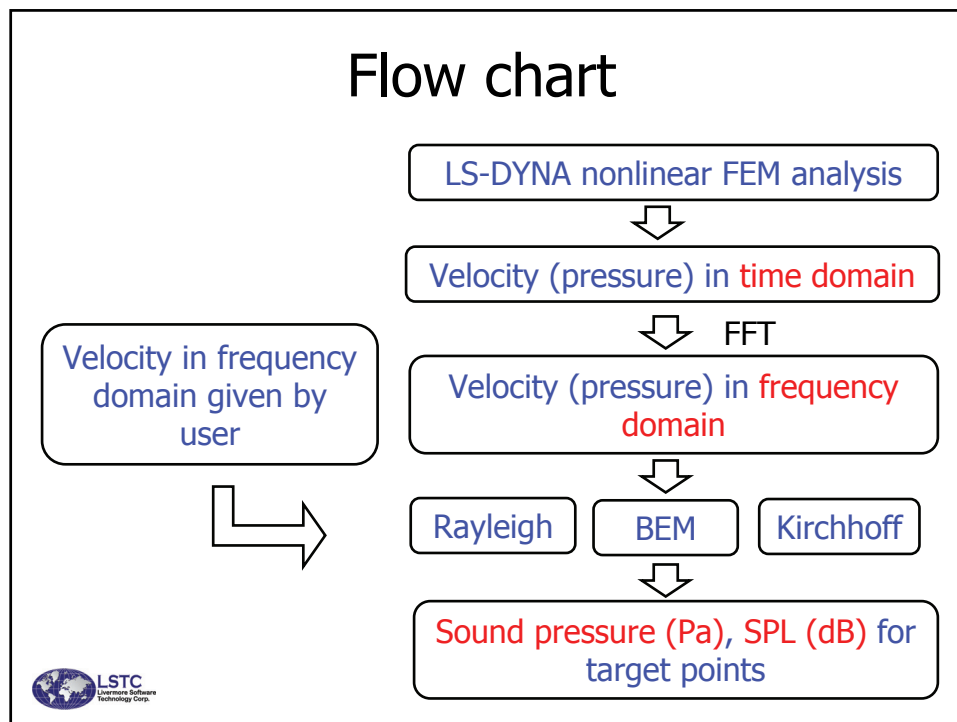

# A golf example

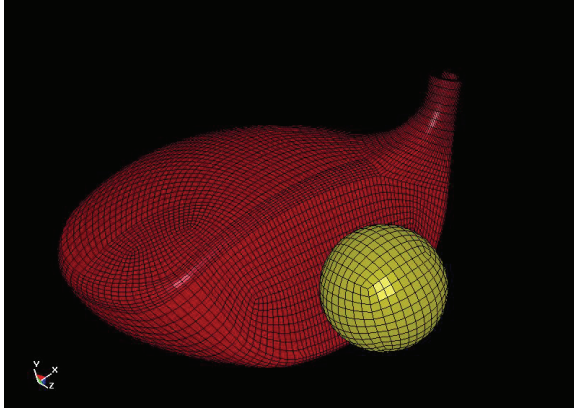

Model information

FEM part

34412 Nodes  
27616 Solid elements

BEM part

6313 Nodes  
6272 Shell elements

Frequency range  
1,000 – 20,000 hz



115

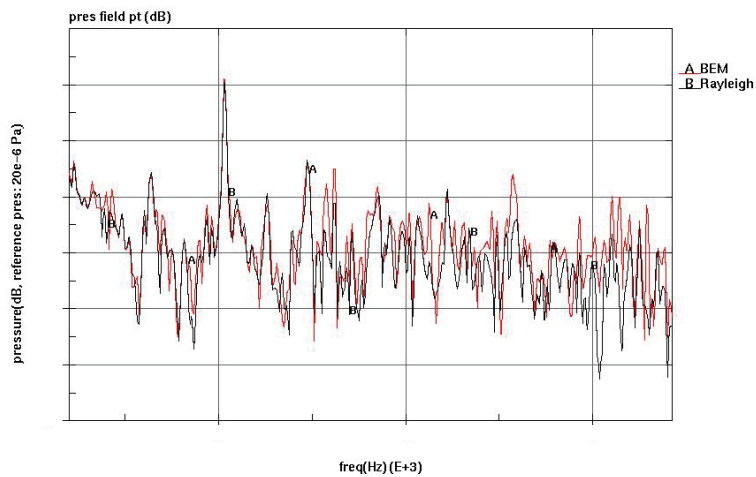

**MPP (8 cpu)**

**Serial**

Elapsed time	12 hours 14 min	102 hours 32 min
--------------	-----------------	------------------



116

## Vibro-acoustic loading

- This option is based on Boeing's vibro-acoustic tool N-FEARA, which has been fully tested and applied in many practical programs within Boeing.
- Solves vibro-acoustic problems in frequency-domain.
- Provides LS-DYNA the capability to analyze the structures subjected to random base-excitation and sonic acoustic loads such as a plane wave, progressive wave, reverberant wave, and turbulent boundary layer wave.
- Capable of handling pre-stress effect due to thermal and mechanical pre-load.
- For examples and user manual, please contact Yun Huang ([huang@lstc.com](mailto:huang@lstc.com))



117

## Vibro-acoustic loading

### INPUT

Structure model, acoustic or vibration loading (Sound Pressure Level or PSD, phase velocity, etc.), Damping (broadband or modal damping), temperature, exposure time, prestress condition, etc.

### OUTPUT

PSD of displacement, velocity, acceleration and stress (nodout\_psd, elout\_psd, accessible by [LS-PREPOST](#))

RMS of displacement, velocity, acceleration and stress (contour plots accessible by [LS-PREPOST](#))



118

## Vibro-acoustic loading

- **\*CONTROL\_VIBRO\_ACOUSTIC**
  - Purpose: Set vibro-acoustic structural analysis control using different options.
- **\*LOAD\_VIBRO\_ACOUSTIC**
  - Purpose: Define an acoustic spectrum load, damping, etc. as a series of load curves.
- **\*DATABASE\_POWER\_SPECTRAL\_DENSITY**
  - Purpose: Define set ID for nodes and elements for PSD (power spectral density) output.
- **\*DATABASE\_POWER\_SPECTRAL\_DENSITY\_FREQUENCY**
  - Purpose: Define range and interval of frequencies for PSD output.



119

## Validation of the tool

RMS of Von Mises stress for an L shaped panel subjected to plane wave excitation.

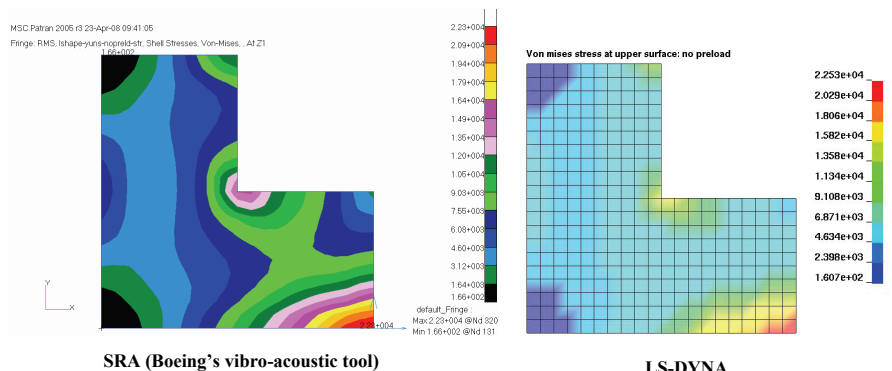

120

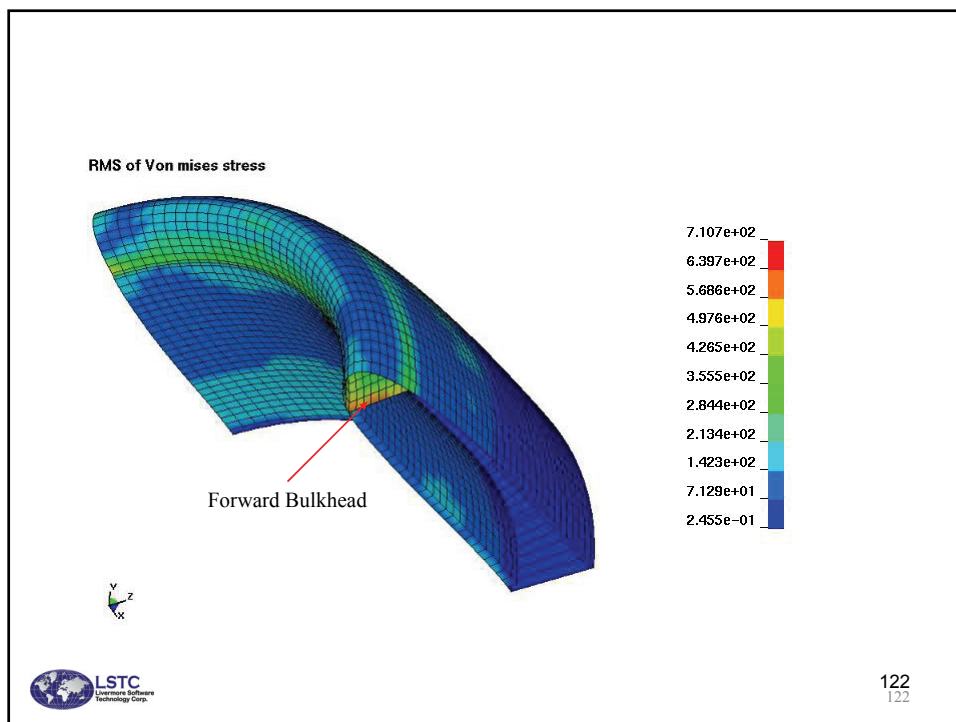
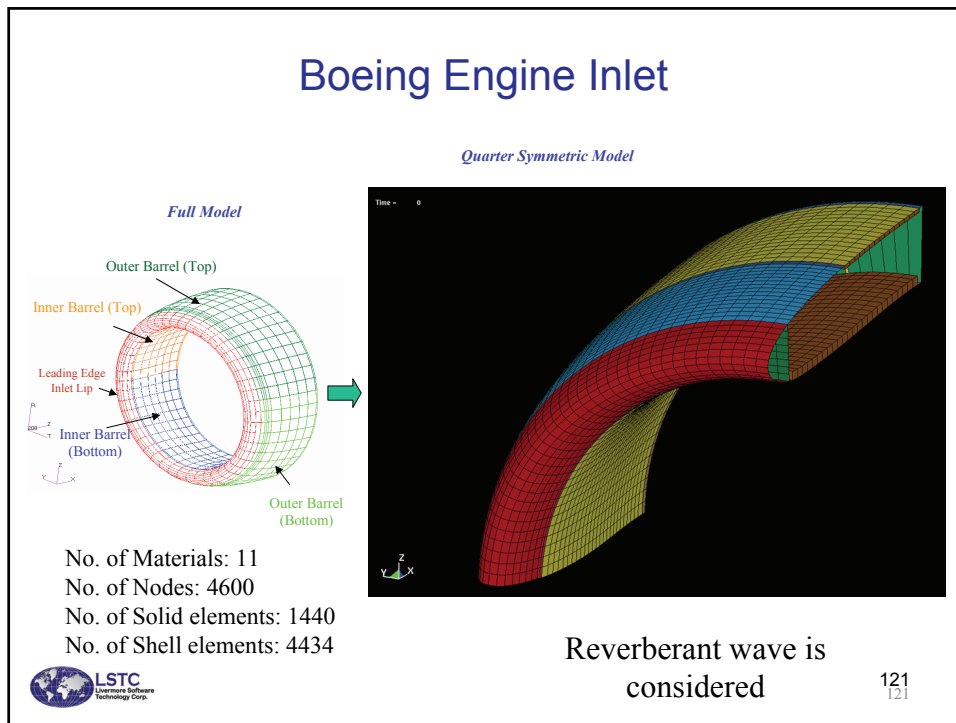



## Conclusions

- LSTC is committed to be the leader in large scale numerical simulations
  - LS-DYNA is developed as a strongly coupled multi-physics solver rather than loosely coupled field equations
  - LSTC is committed to providing dummy, barrier, and head form models with LS-Dyna to reduce customer costs.
  - LSTC is actively working on the most challenging issues related to both hardware and software
  - Many of LSTC's innovations are well accepted by industrial users
- LSTC is not content with what has been achieved
  - New features and algorithms will be continuously implemented to handle new challenges and applications



123

# The end



124