

The interaction between LS-OPT, ANSA and μ ETA

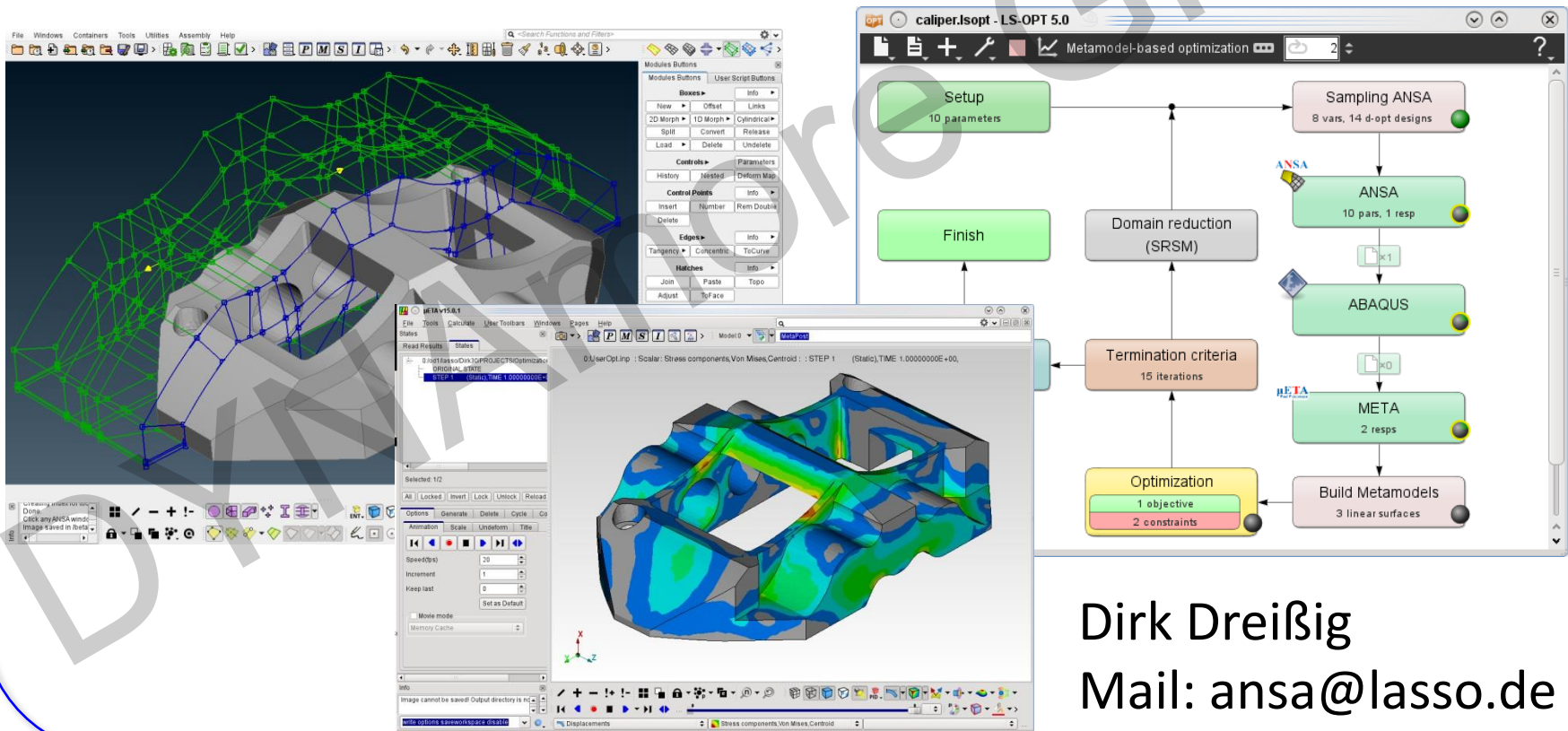

Dirk Dreißig
 Mail: ansa@lasso.de

For what **ANSA** & **μETA**?

DYNAMORE GmbH

For what ANSA & μ ETA?

- ANSA for model-change according to design variables (everything besides LS-DYNA with *PARAMETER)

For what ANSA & μ ETA?

- **ANSA** for model-change according to design variables (everything besides LS-DYNA with *PARAMETER)
- **μ ETA** for results extraction of arbitrary (supported) solvers (besides LS-DYNA)

For what ANSA & μ ETA?

- **ANSA** for model-change according to design variables (everything besides LS-DYNA with *PARAMETER)
- **μ ETA** for results extraction of arbitrary (supported) solvers (besides LS-DYNA)
- **Setup phase**
 - design variables defined in **ANSA** → transfer to LS-OPT
 - histories and responses defined in **μ ETA** → transfer to LS-OPT

For what ANSA & μ ETA?

- **ANSA** for model-change according to design variables (everything besides LS-DYNA with *PARAMETER)
- **μ ETA** for results extraction of arbitrary (supported) solvers (besides LS-DYNA)
- **Setup phase**
 - design variables defined in **ANSA** → transfer to LS-OPT
 - histories and responses defined in **μ ETA** → transfer to LS-OPT
- **Optimization (Run) phase**
 - design variables controlled by LS-OPT → transfer to **ANSA**
 - histories and responses calculated by **μ ETA** → transfer to LS-OPT

Optimization Setup

ANSA → Solver → META → LS-OPT

DYNAMAmore GmbH

Optimization Setup

ANSA → Solver → META → LS-OPT

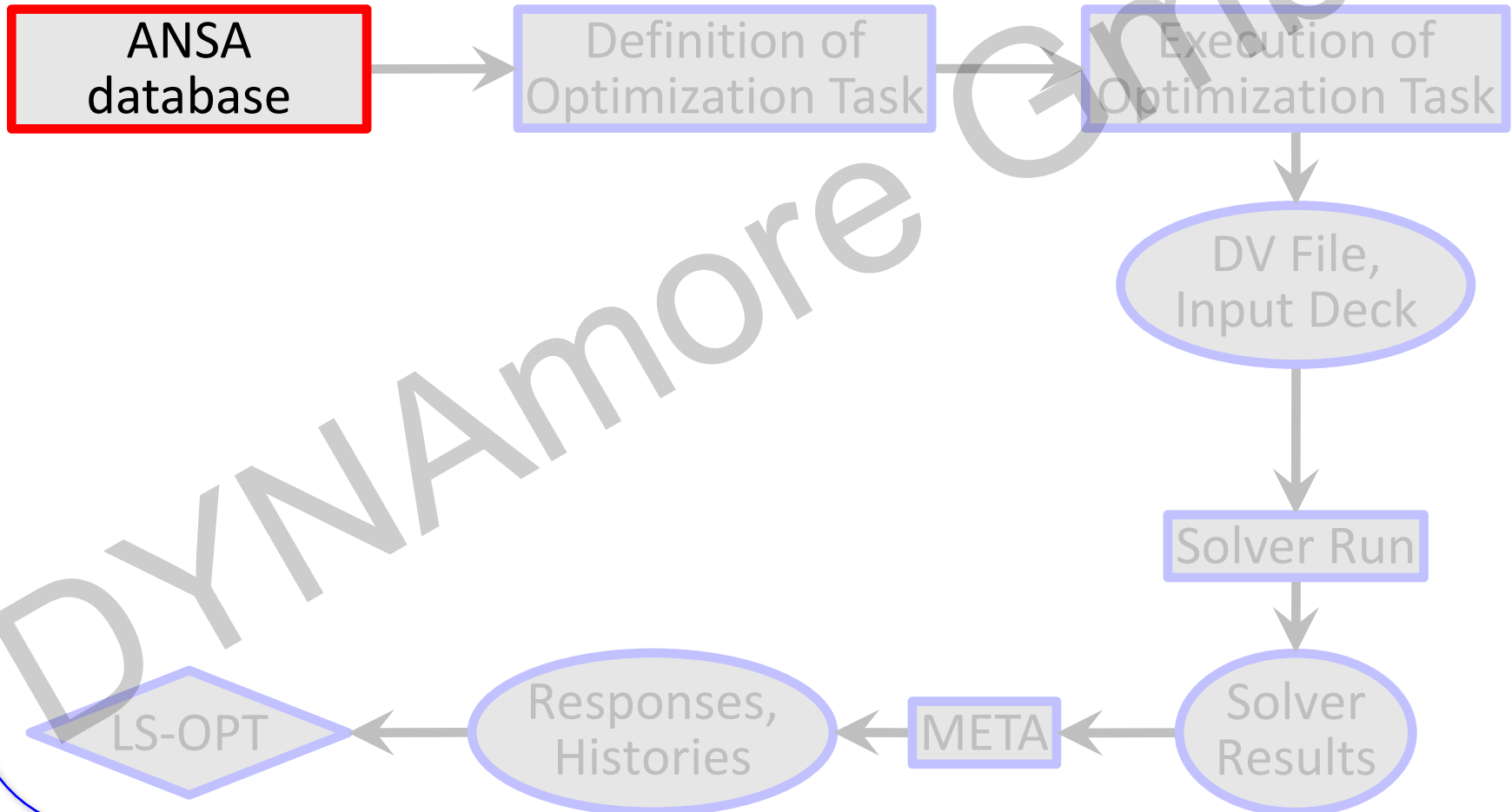

Optimization Setup

ANSA → Solver → META → LS-OPT

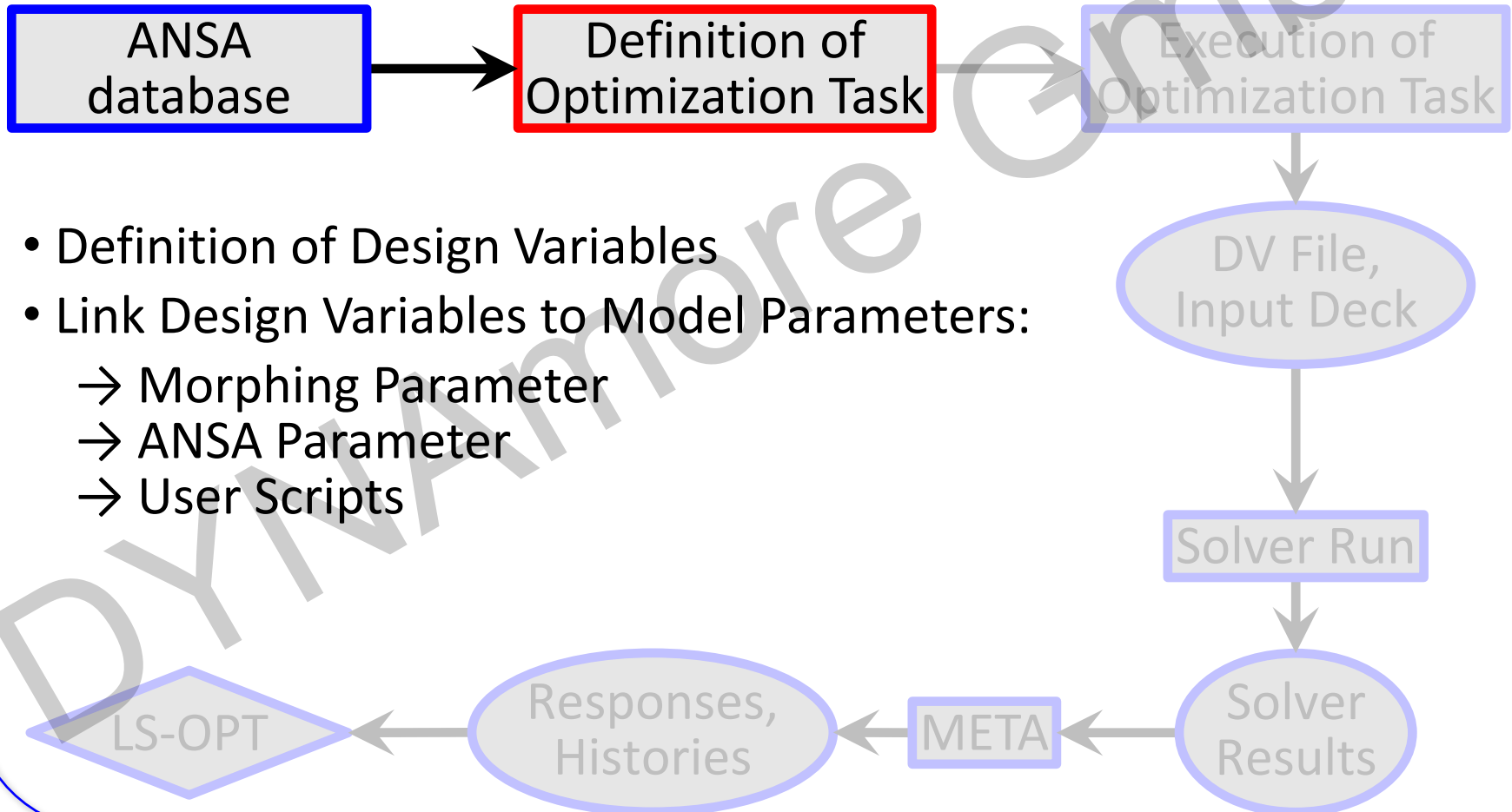

Optimization Setup

ANSA → Solver → META → LS-OPT

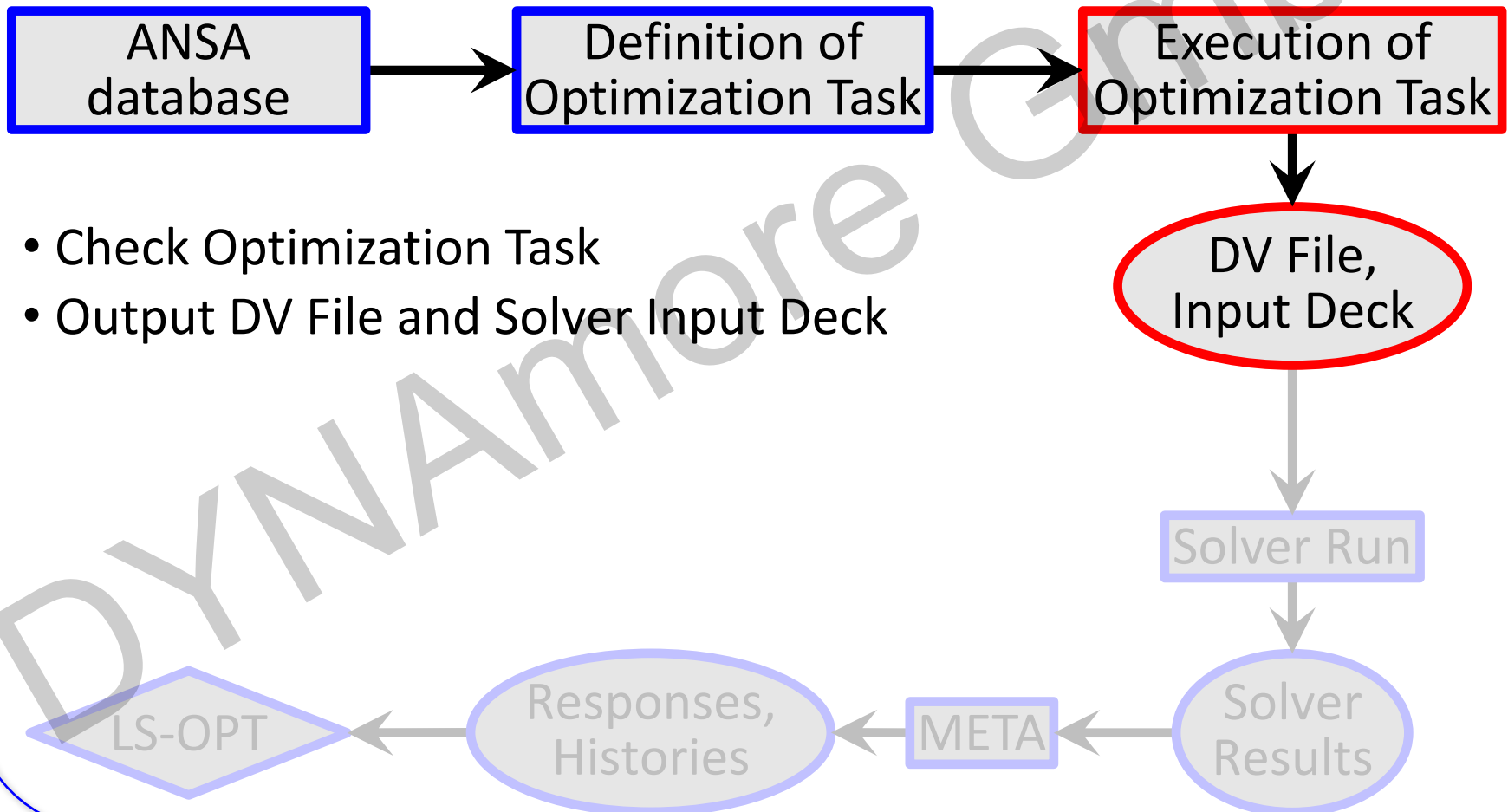

Optimization Setup

ANSA → **Solver** → META → LS-OPT

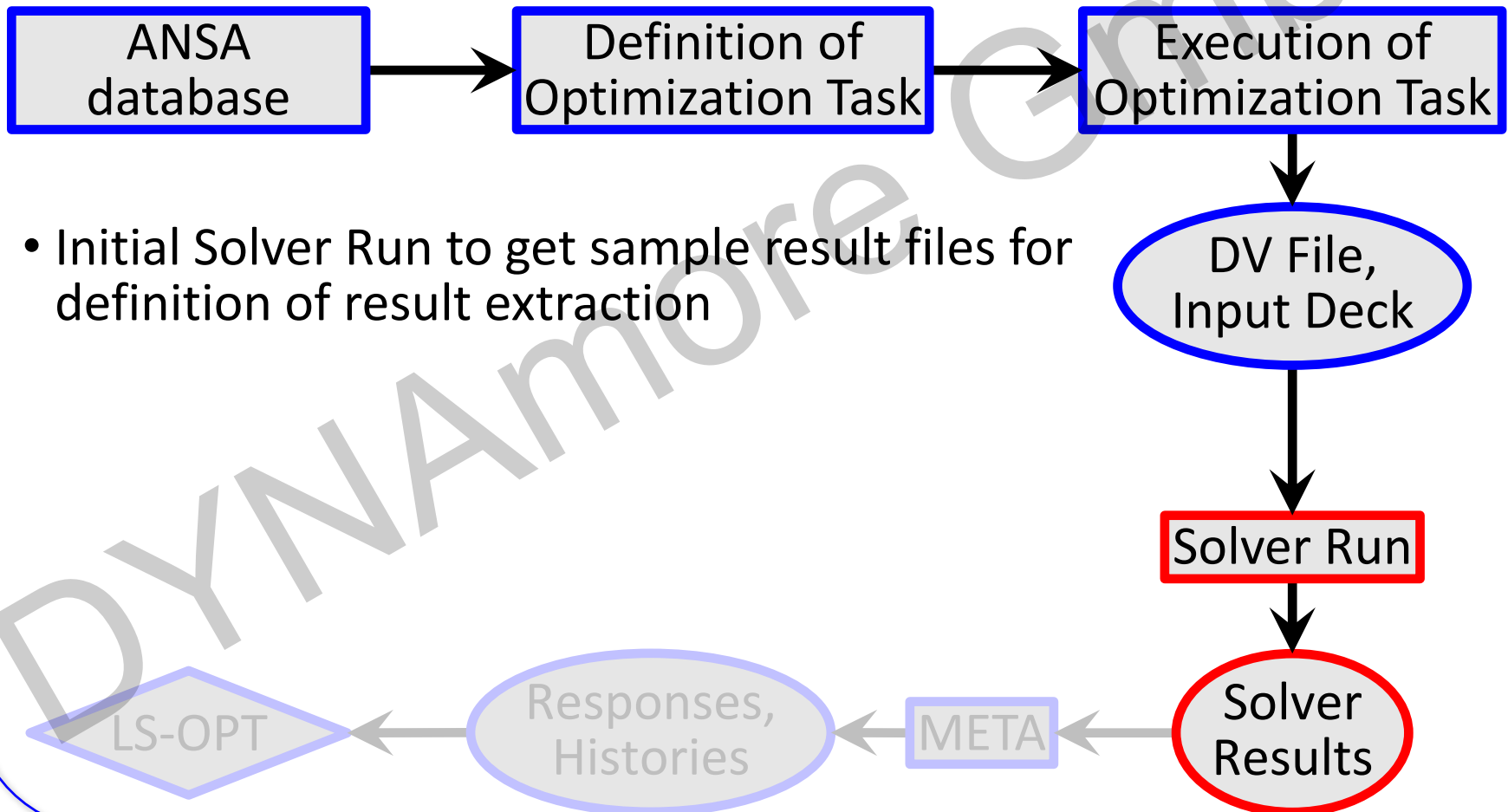

Optimization Setup

ANSA → Solver → **META** → LS-OPT

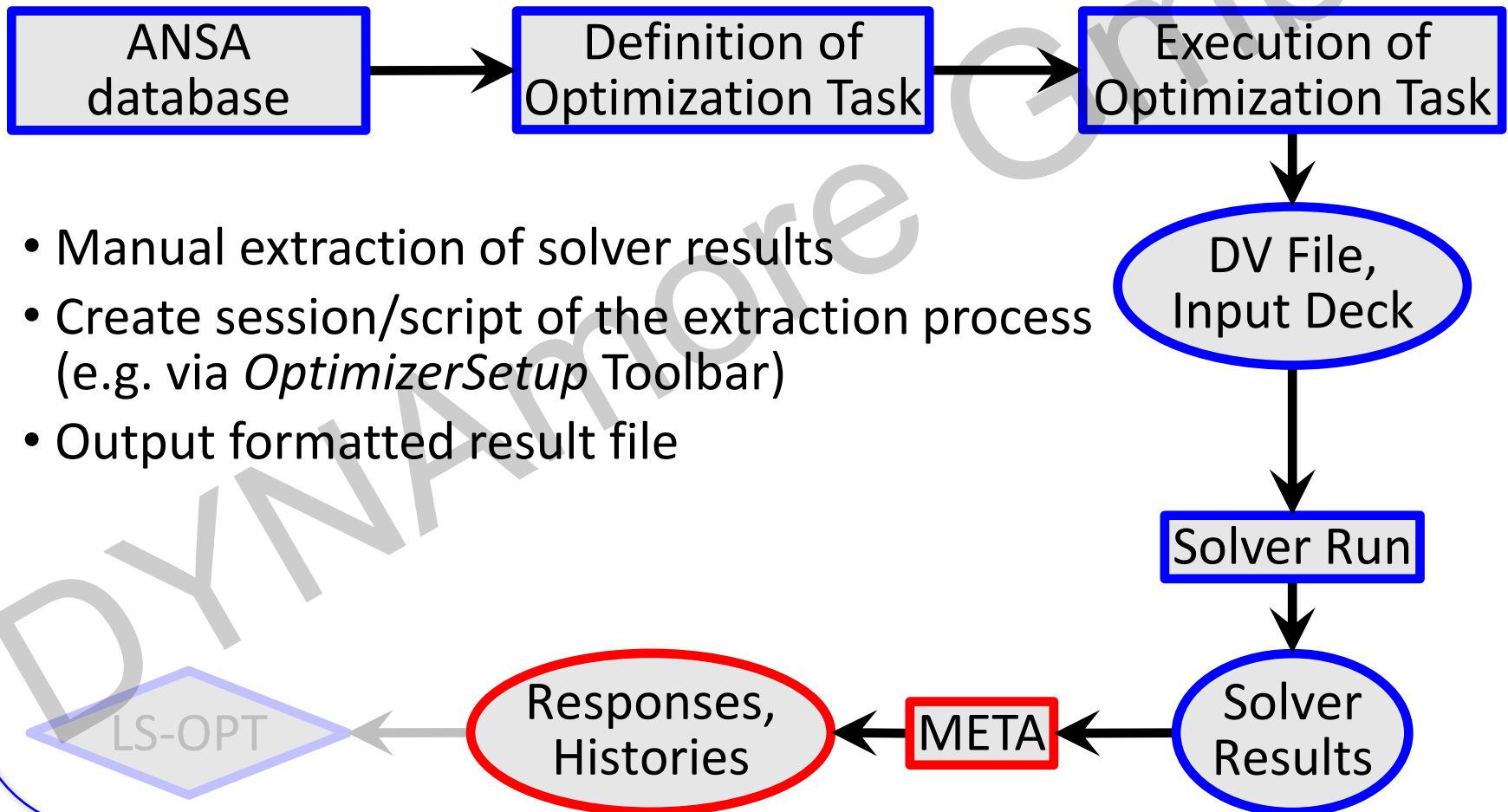

Optimization Setup

ANSA → Solver → META → **LS-OPT**

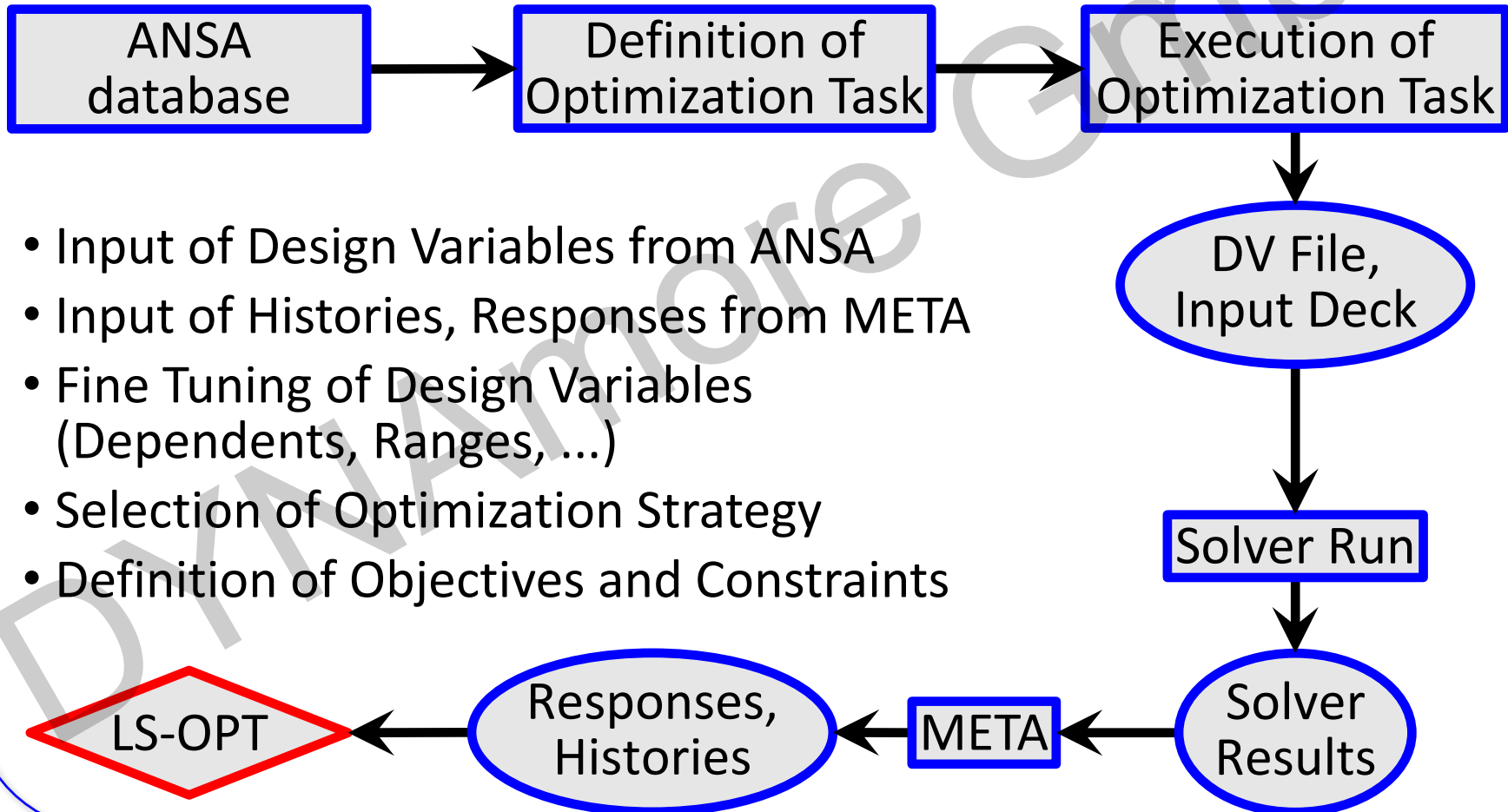

ANSA – Optimization Task

3 main task items

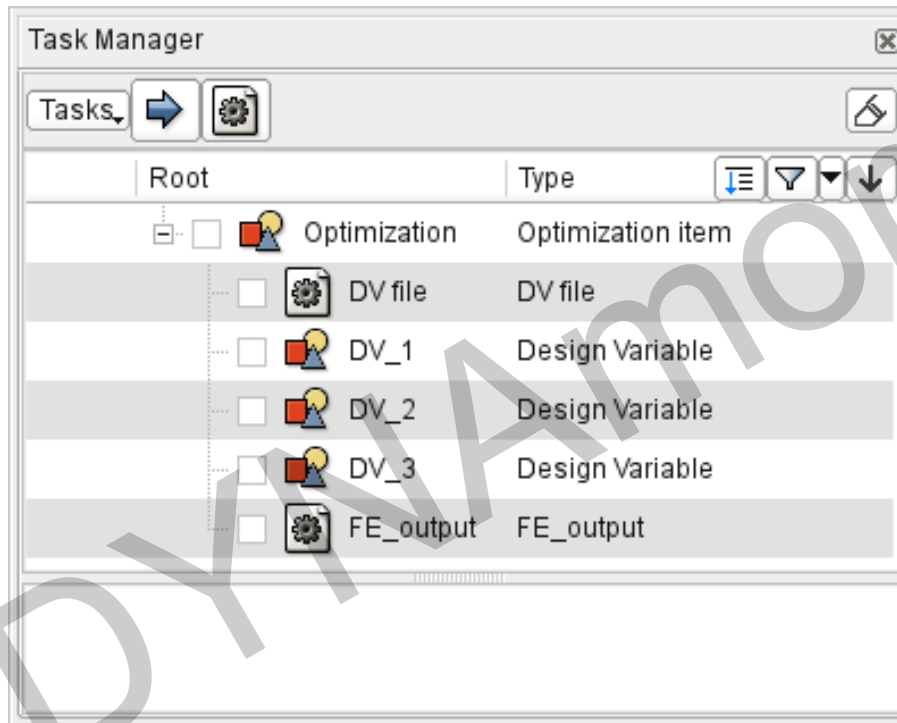

ANSA – Optimization Task

3 main task items

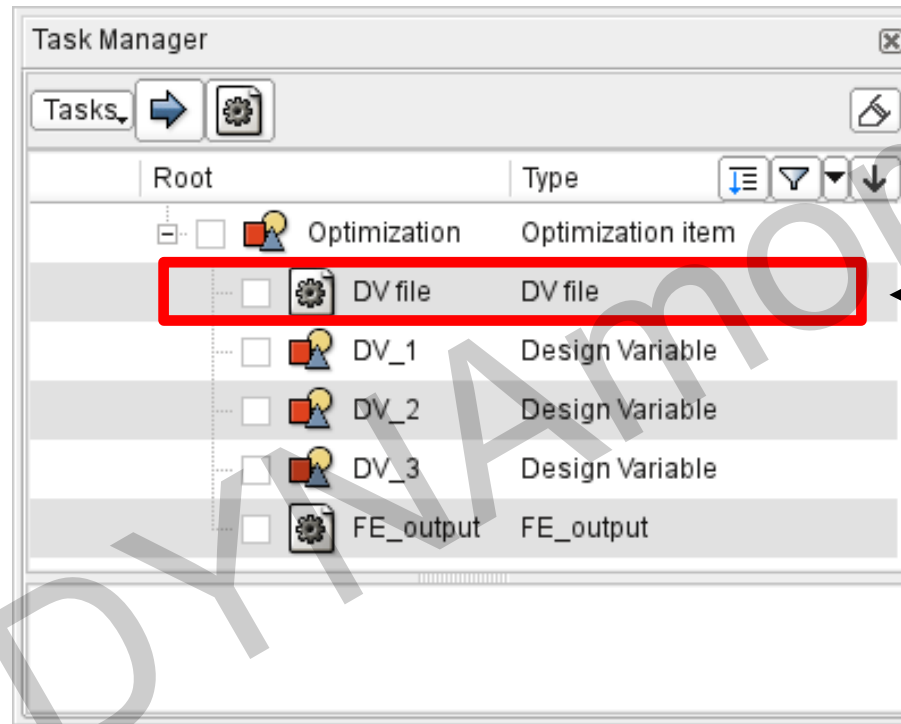

1. Design Variable File

ANSA – Optimization Task

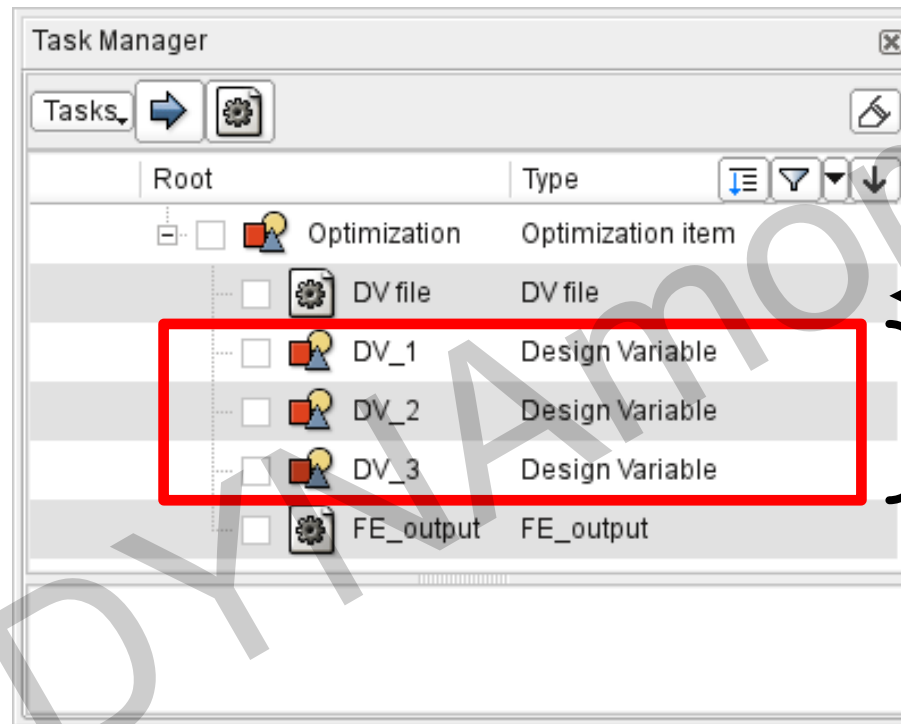

3 main task items

1. Design Variable File

2. Design Variables

ANSA – Optimization Task

3 main task items

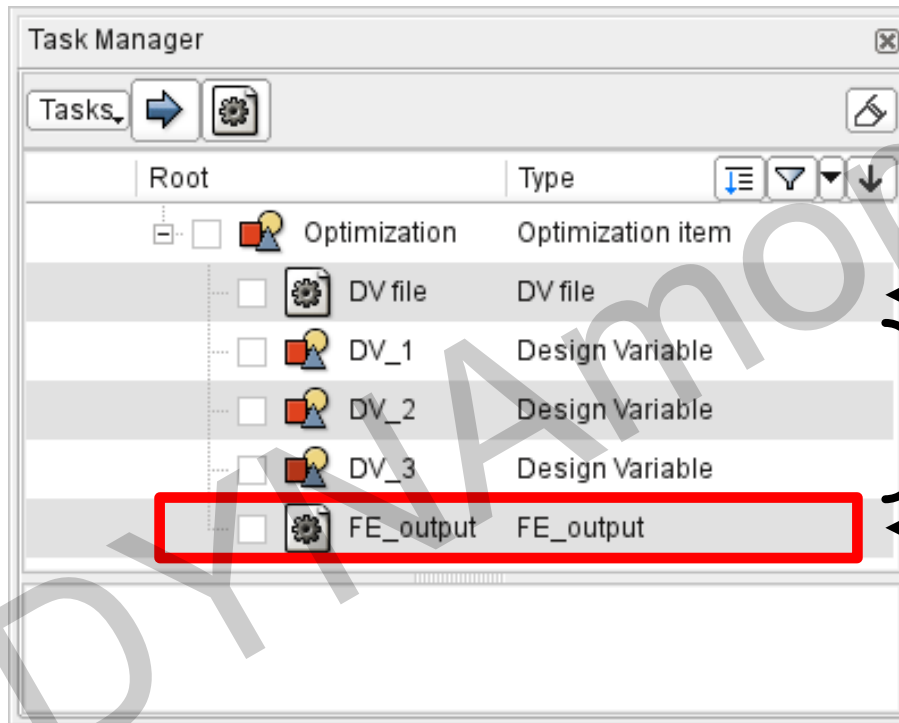

1. Design Variable File

2. Design Variables

3. Output Solver Deck

ANSA – Optimization Task

Design Variable File

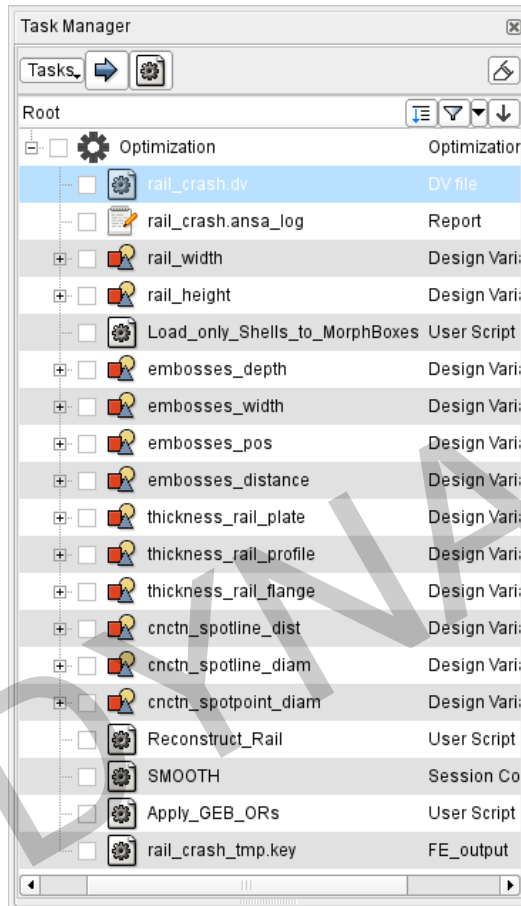

ANSA – Optimization Task

Design Variable File

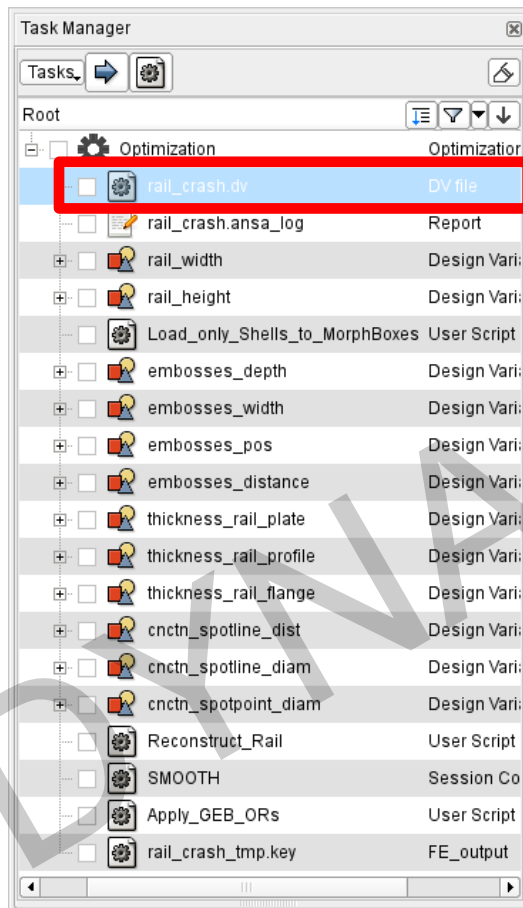

```
#
# ANSA_VERSION: 14.2.3
#
# file created by A N S A Mon Feb 17 17:13:25 2014
#
# Output from:
# /od1/lasso/Dirk30/PROJECTS/Optimierung_Rail_LS-OPT/Rail_MD0/rail_crash.ansa
#
# DESIGN VARIABLES
#-----
# ID | DESIGN VARIABLE NAME | TYPE | RANGE | CURRENT VALUE | MIN VALUE --> MAX VALUE | STEP
#-----
10, rail_width, REAL, BOUNDS, 10., -20., 20.
11, rail_height, REAL, BOUNDS, 10., -20., 20.
1, embosses_depth, REAL, BOUNDS, 7., 0., 7.
3, embosses_width, REAL, BOUNDS, 10., -10., 10.
2, embosses_pos, REAL, BOUNDS, -15., -50., 20.
7, embosses_distance, REAL, BOUNDS, -15., -15., 50.
4, thickness_rail_plate, REAL, STEP, 1.5, 0.5, 2., 0.1
5, thickness_rail_profile, REAL, STEP, 1.5, 0.5, 2., 0.1
8, thickness_rail_flange, REAL, STEP, 1.5, 0.5, 3., 0.1
6, cncnt_spotline_dist, REAL, BOUNDS, 50., 20., 100.
9, cncnt_spotline_diam, REAL, STEP, 5., 2., 10., 1.
12, cncnt_spotpoint_diam, REAL, STEP, 5., 2., 10., 1.
#-----
```

Correctly formatted for
import in LS-OPT

ANSA – Optimization Task

Design Variables → Morphing Parameters

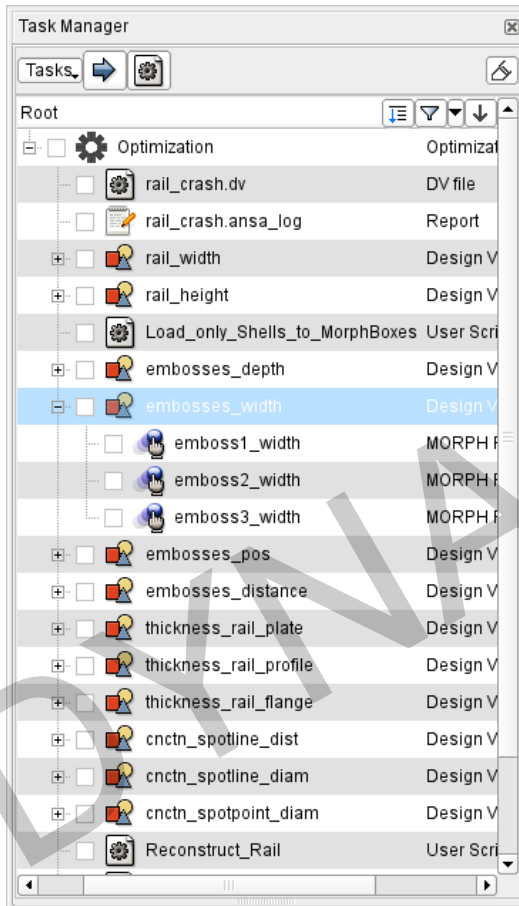

ANSA – Optimization Task

Design Variables → Morphing Parameters

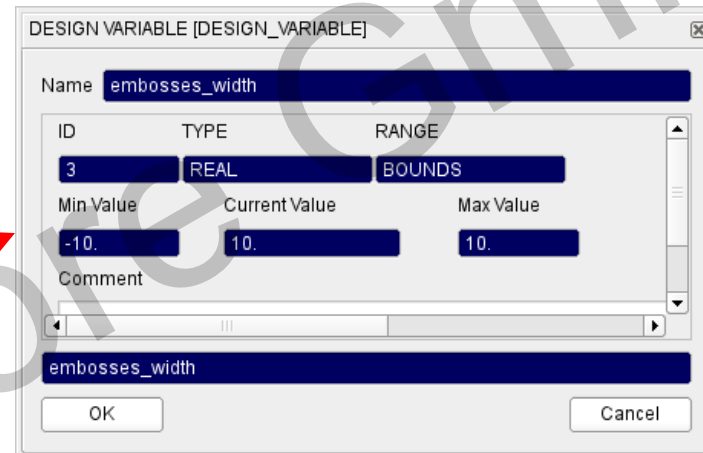
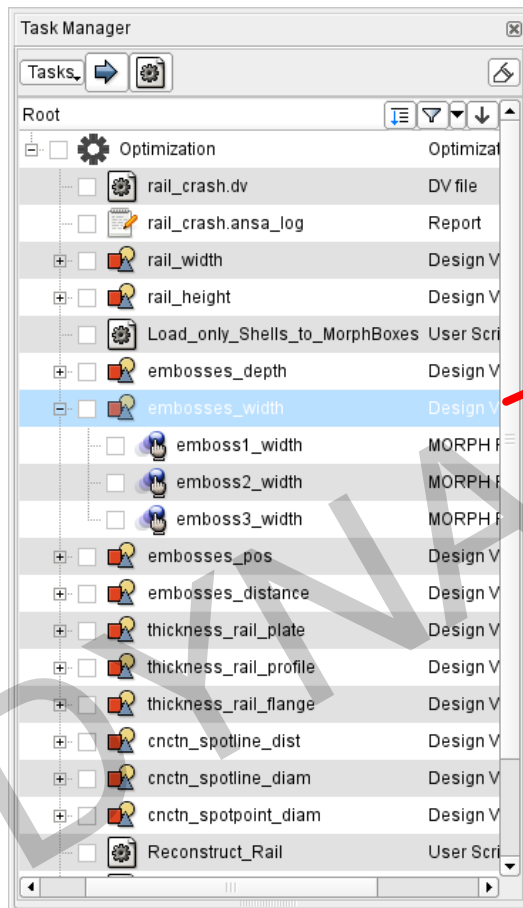

ANSA – Optimization Task

Design Variables → Morphing Parameters

Task Manager

Tasks

Root

- Optimization
- rail_crash.dv (DV file)
- rail_crash.ansa_log (Report)
- rail_width (Design V)
- rail_height (Design V)
- Load_only_Shells_to_MorphBoxes (User Scri)
- embosses_depth (Design V)
- embosses_width (Design V)**
 - emboss1_width (MORPH P)
 - emboss2_width (MORPH P)
 - emboss3_width (MORPH P)
- embosses_pos (Design V)
- embosses_distance (Design V)
- thickness_rail_plate (Design V)
- thickness_rail_profile (Design V)
- thickness_rail_flange (Design V)
- cnctn_spotline_dist (Design V)
- cnctn_spotline_diam (Design V)
- cnctn_spotpoint_diam (Design V)
- Reconstruct_Rail (User Scri)

DESIGN VARIABLE [DESIGN_VARIABLE]

Name: embosses_width

ID	TYPE	RANGE
3	REAL	BOUNDS

Min Value: -10 Current Value: 10 Max Value: 10

Comment:

embosses_width

OK Cancel

Morph Parameter Table for embosses_width

Id	Name	Type	Current value	Expression	Used by DV	At the end apply
11	emboss3_depth unt	Translate	embosses_width		embosses_depth	Nothing
13	emboss1_width	Translate	embosses_width/2		embosses_width	Nothing
14	emboss2_width	Translate	embosses_width/2		embosses_width	Nothing
15	emboss3_width	Translate	embosses_width/2		embosses_width	Nothing
16	embosses_pos	Translate	embosses_width		embosses_pos	Nothing

OK Cancel

ANSA – Optimization Task

Design Variables → Morphing Parameters

Shape modification

Design Variable = 10.0

Morphing Parameter

Width of depressions

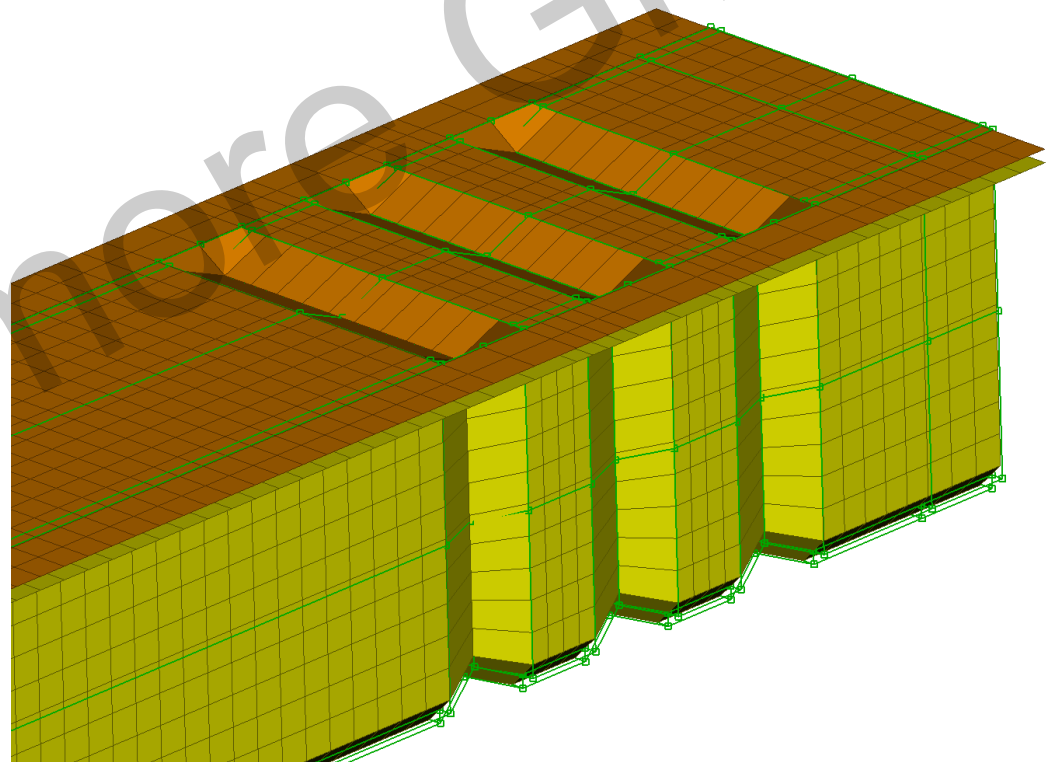

ANSA – Optimization Task

Design Variables → Morphing Parameters

Shape modification

Design Variable = -5.0

Morphing Parameter

Width of depressions

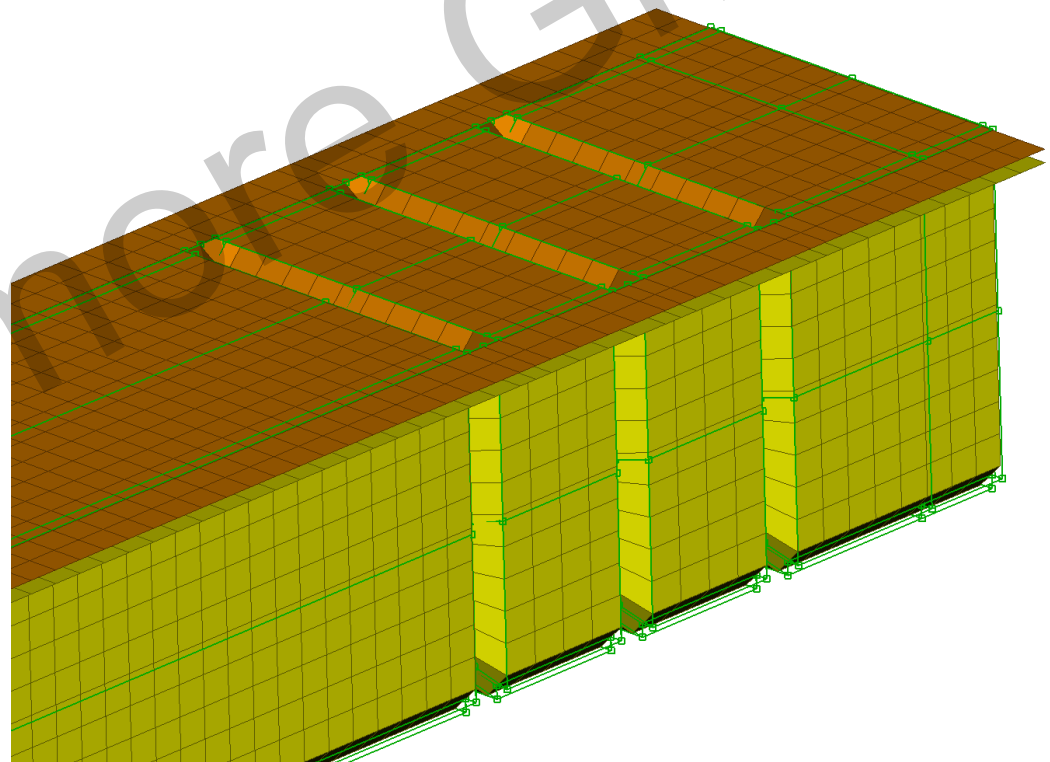

ANSA – Optimization Task

Design Variables → ANSA Parameters

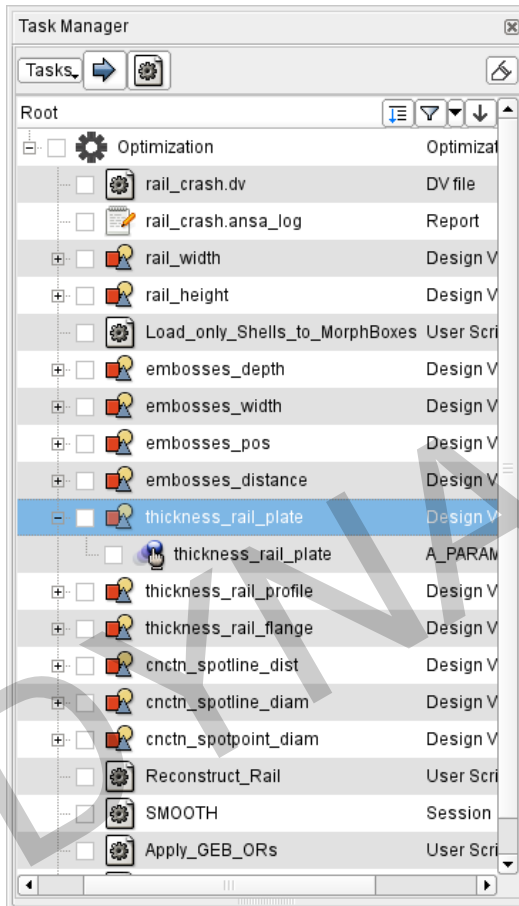

ANSA – Optimization Task

Design Variables → ANSA Parameters

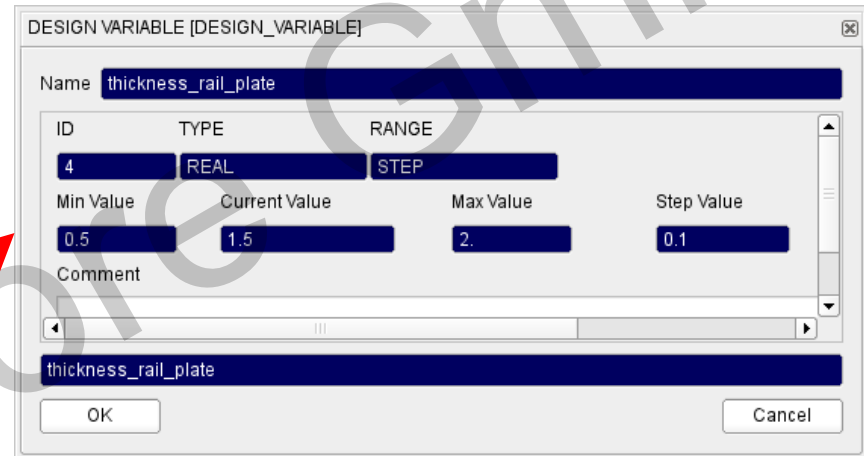
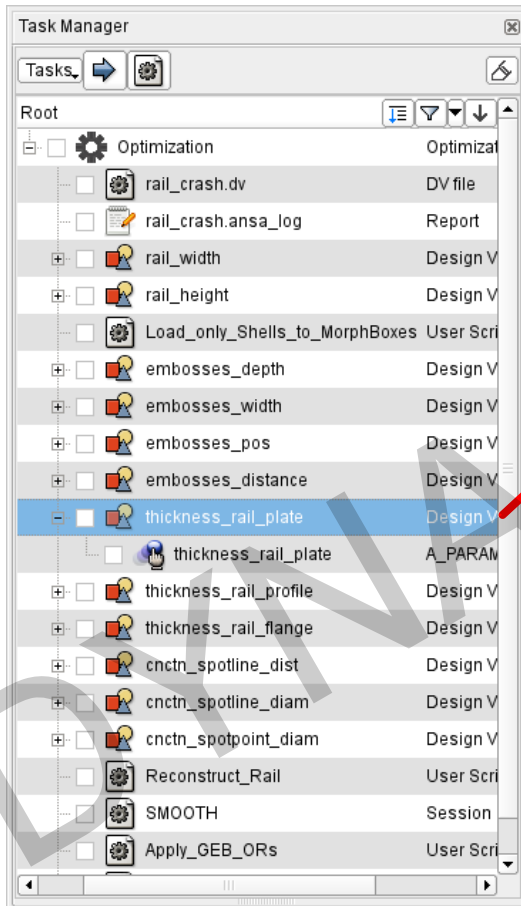

ANSA – Optimization Task

Design Variables → ANSA Parameters

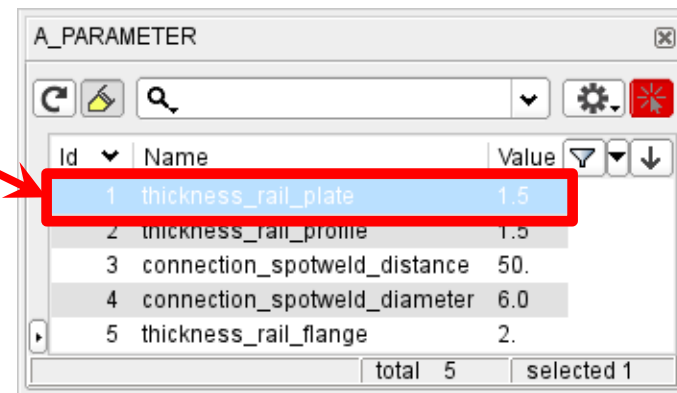
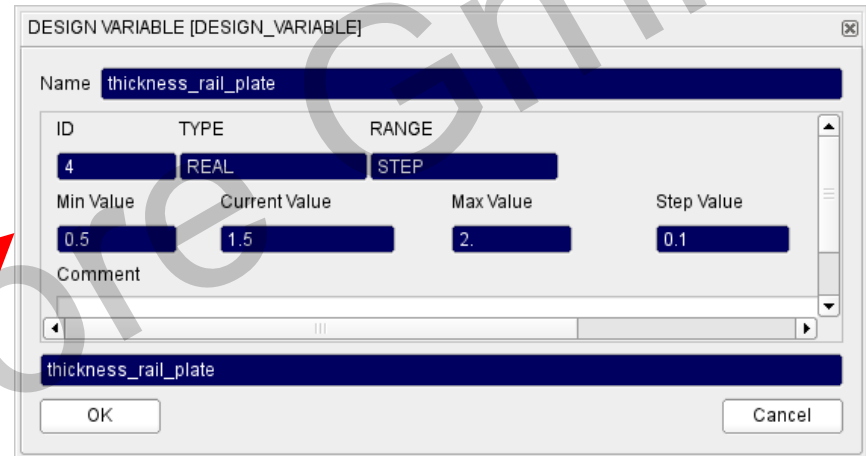
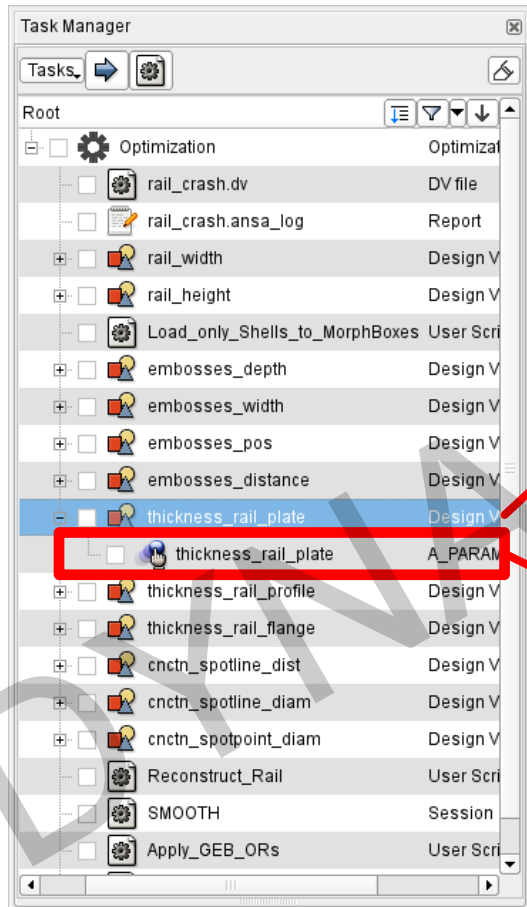

ANSA – Optimization Task

Design Variables → ANSA Parameters

Modification of shell thicknesses, materials, etc.

*PART & *SECTION_SHELL [SECTION_SHELL]

Name rail_profile

FROZEN_ID	FROZEN_DELETE	DEFINED	TRIM	USE_IN_MODEL
NO	NO	YES	NO	YES

PID	SECID	MID	EOSID	HGID	GRAV	ADPOPT	TMID
3		2		3	0	0	

SECID	ELFORM	SHRF	NIP	PROPT	QR/IRID	QR	ICOMP
	16	1	2	1.0	QR	0.0	0

T1	T2	T3	T4	NLOC	MAREA	IDOF	EDGSET
1.5				0		0	

OK ColorEdit Cancel

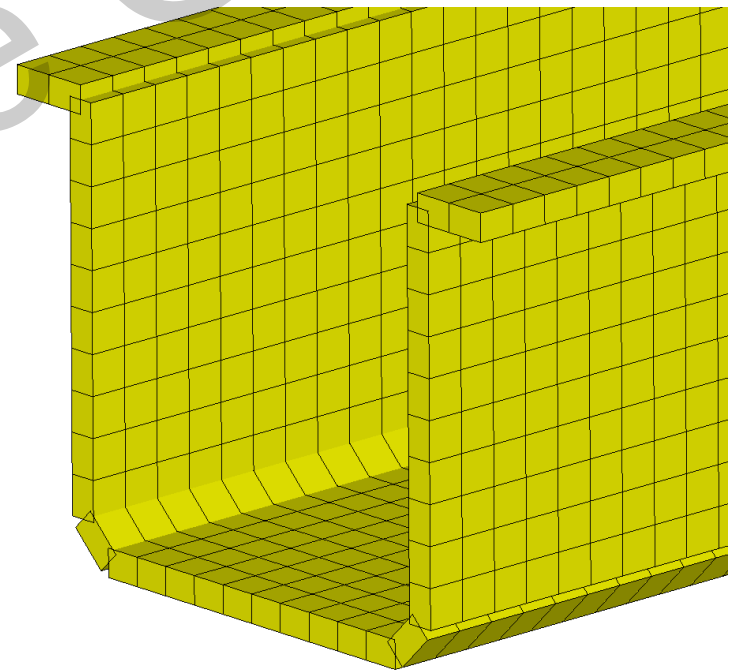

ANSA – Optimization Task

Design Variables → ANSA Parameters

Modification of shell thicknesses, materials, etc.

*PART & *SECTION_SHELL [SECTION_SHELL]

Name: rail_profile

FROZEN_ID: NO, FROZEN_DELETE: NO, DEFINED: YES, TRIM: NO, USE_IN_MODEL: YES

PID	SECID	MID	EOSID	HGID	GRAV	ADPOPT	TMID
3		2		3	0	0	
SECID	ELFORM	SHRF	NIP	PROPT	QR/IRID	QR	ICOMP
	16	1	2	1.0	QR	0.0	0
T1	T2	T3	T4	NLOC	MAREA	IDOF	EDGSET
1.5				0		0	

OK ColorEdit Cancel

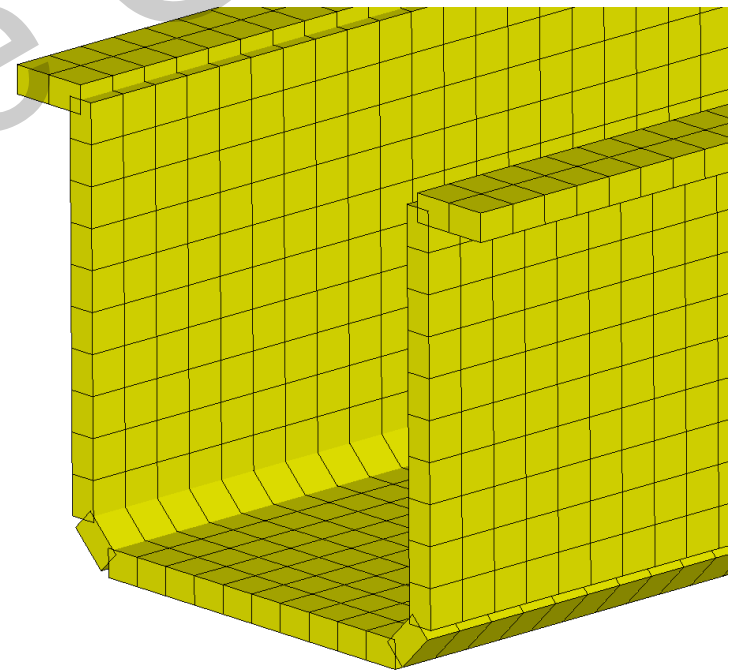

ANSA Parameter

Design Variable = 5.0

ANSA – Optimization Task

Design Variables → ANSA Parameters

Modification of shell thicknesses, materials, etc.

*PART & *SECTION_SHELL [SECTION_SHELL]

Name: rail_profile

FROZEN_ID: NO, FROZEN_DELETE: NO, DEFINED: YES, TRIM: NO, USE_IN_MODEL: YES

PID	SECID	MID	EOSID	HGID	GRAV	ADDOPT	TMID
3		2		3	0	0	
SECID	ELFORM	SHRF	NIP	PROPT	QR/IRID	QR	ICOMP
	16	1	2	1.0	QR	0.0	0
T1	T2	T3	T4	NLOC	MAREA	IDOF	EDGSET
1.5				0		0	

OK ColorEdit Cancel

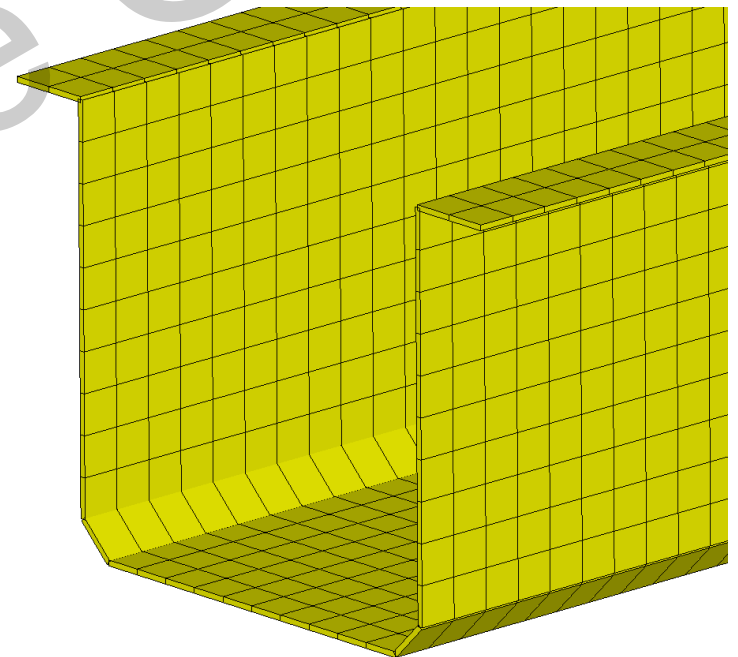

ANSA Parameter

Design Variable = 1.0

ANSA – Optimization Task

Design Variables → ANSA Parameters

Modification of connections (weld spot distance, diameter, etc.)

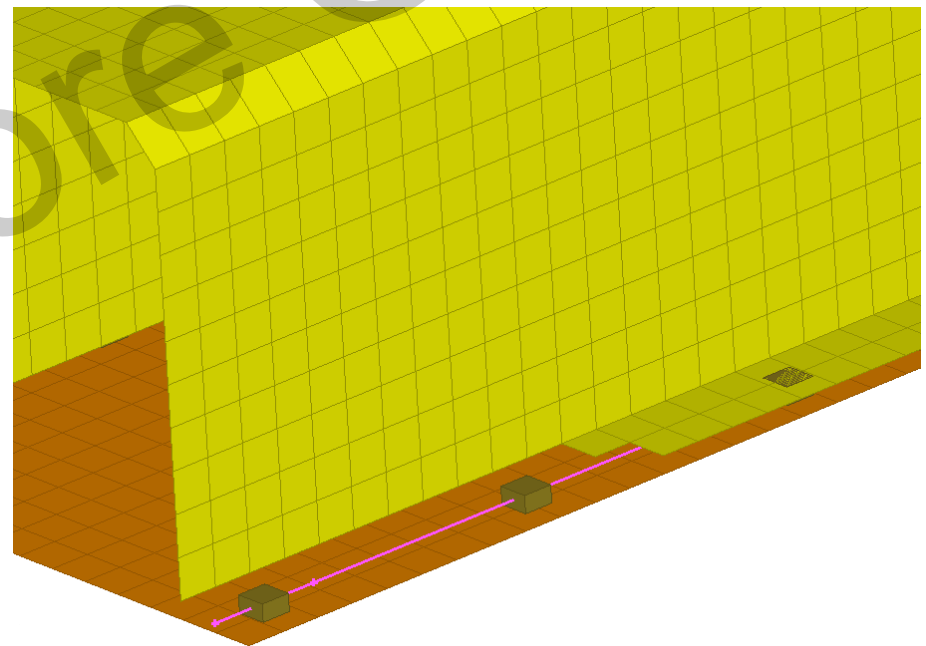
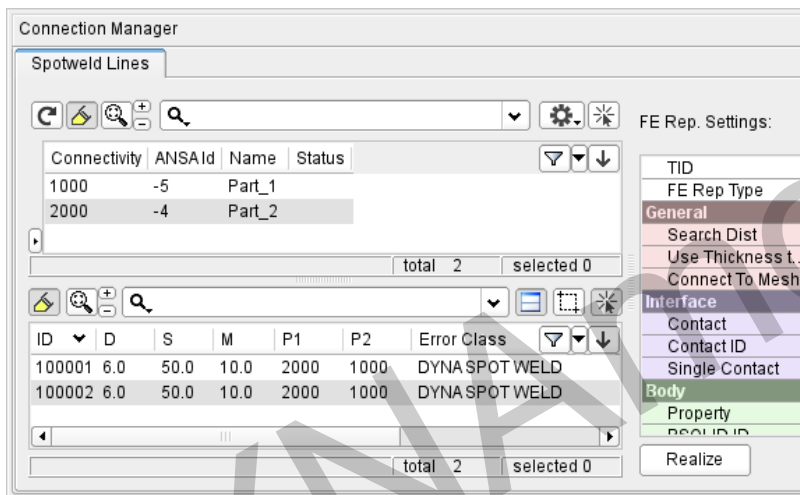

ANSA – Optimization Task

Design Variables → ANSA Parameters

Modification of connections (weld spot distance, diameter, etc.)

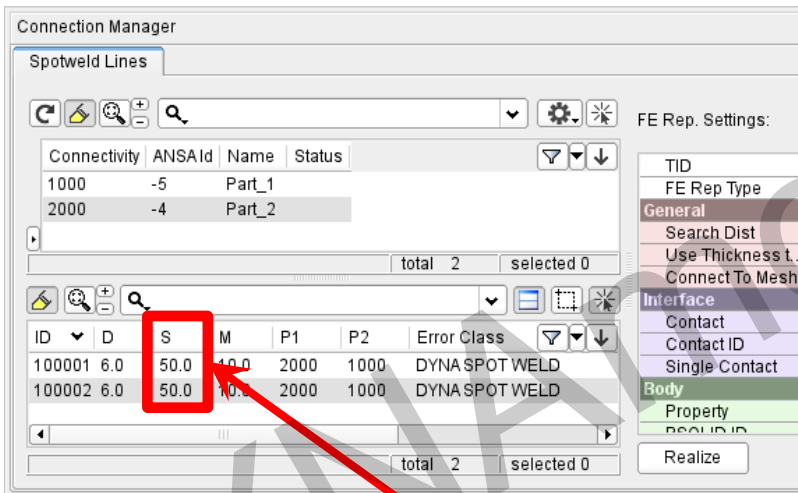

ANSA Parameter

Design Variable (weld spot distance) = 50

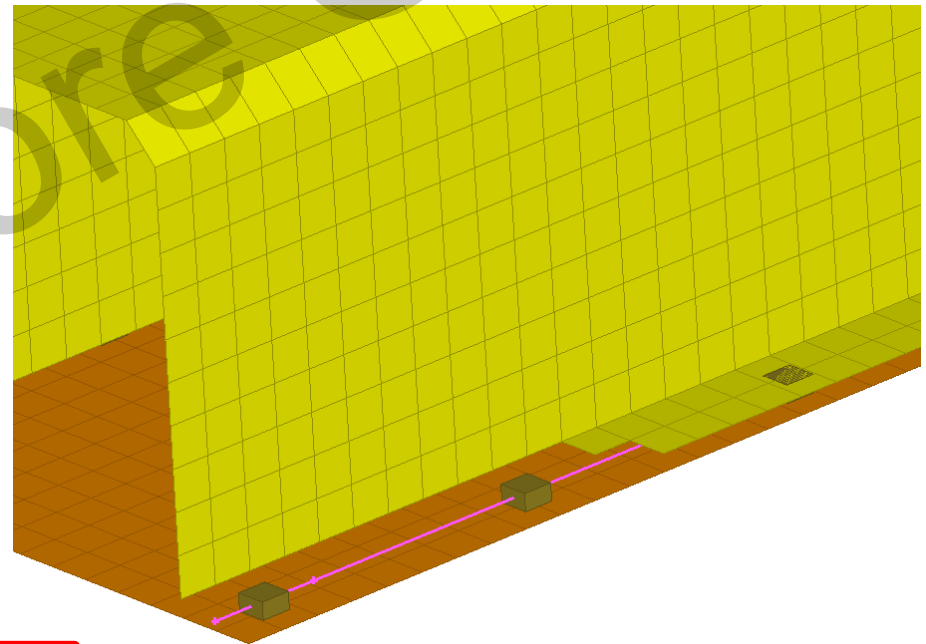

ANSA – Optimization Task

Design Variables → ANSA Parameters

Modification of connections (weld spot distance, diameter, etc.)

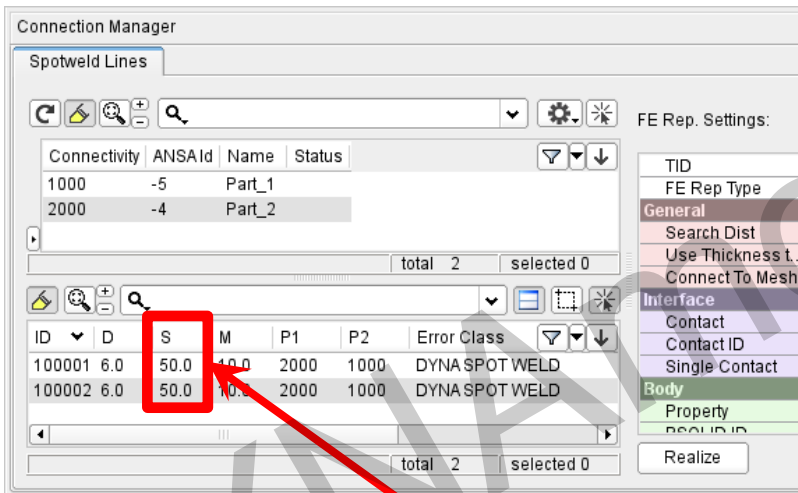

ANSA Parameter

Design Variable (weld spot distance) = 20

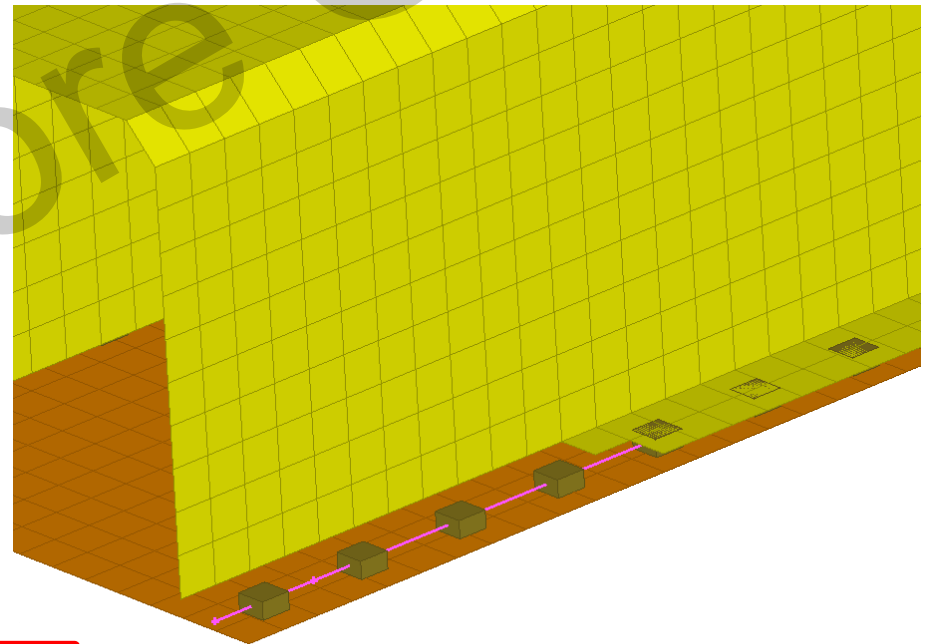

ANSA – Optimization Task

Design Variables → ANSA Parameters

Modification of connections (weld spot distance, diameter, etc.)

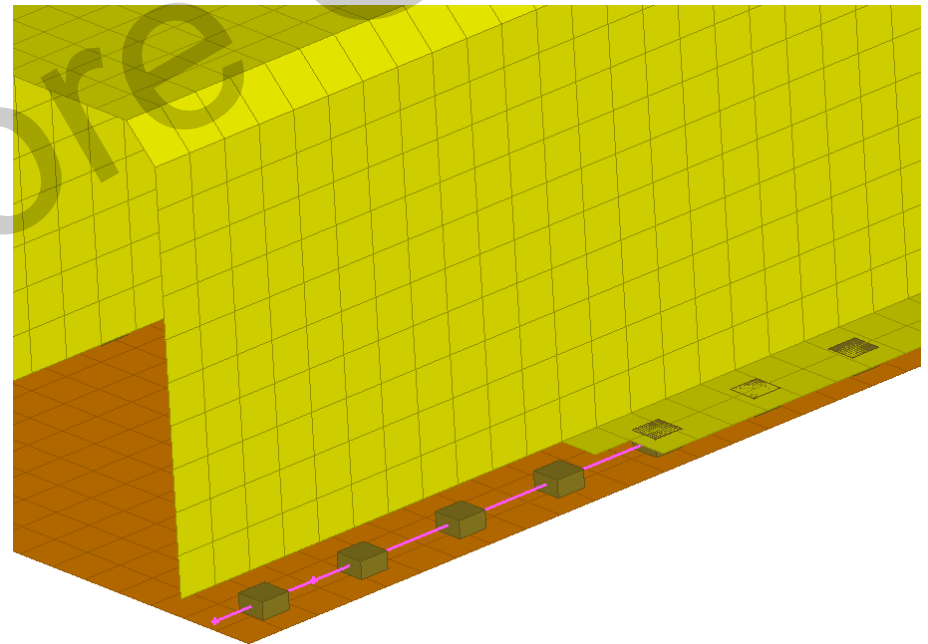
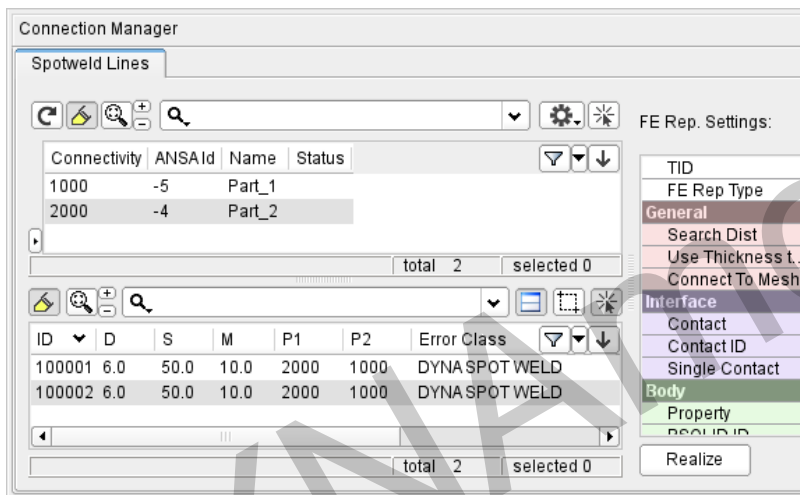

ANSA – Optimization Task

Design Variables → ANSA Parameters

Modification of connections (weld spot distance, diameter, etc.)

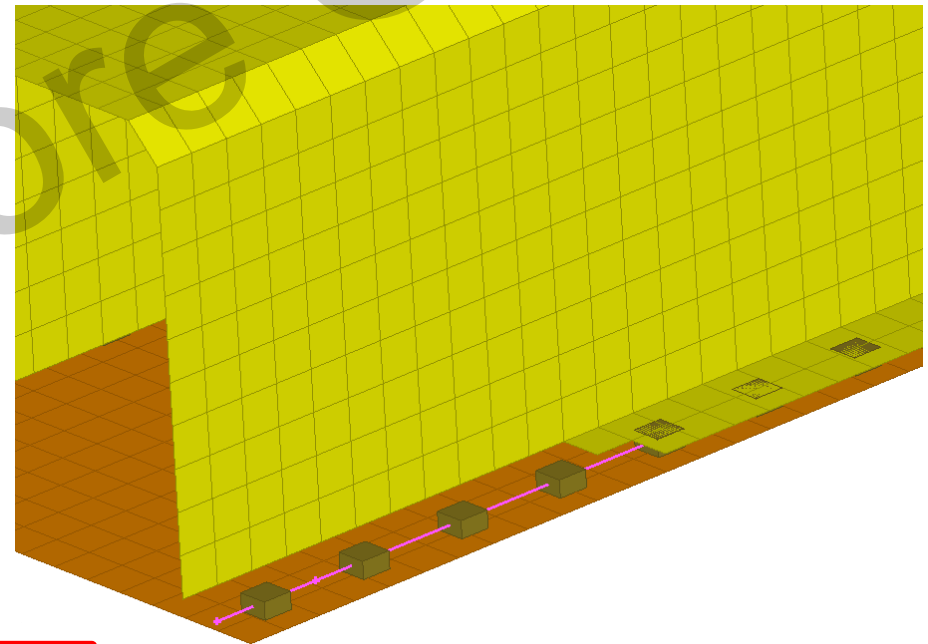
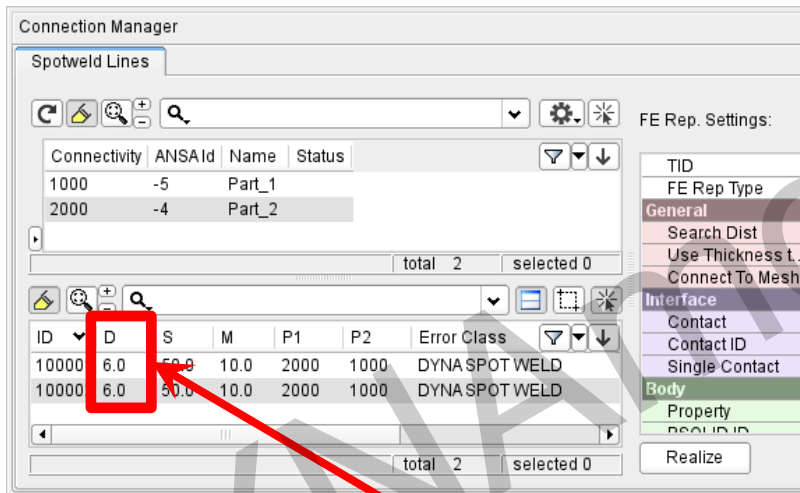

ANSA Parameter

Design Variable (weld spot diameter) = 6.0

ANSA – Optimization Task

Design Variables → ANSA Parameters

Modification of connections (weld spot distance, diameter, etc.)

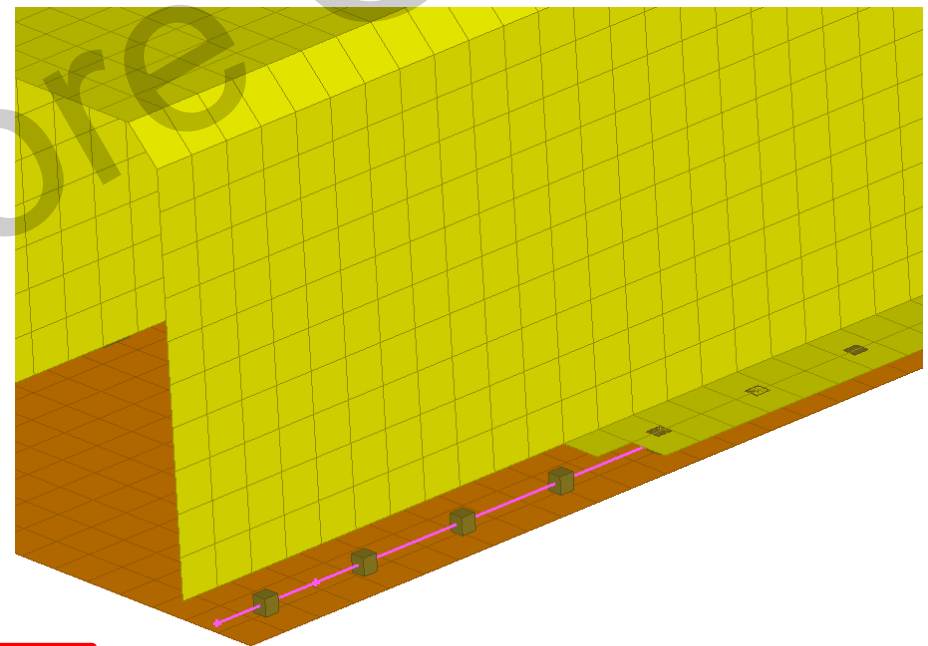
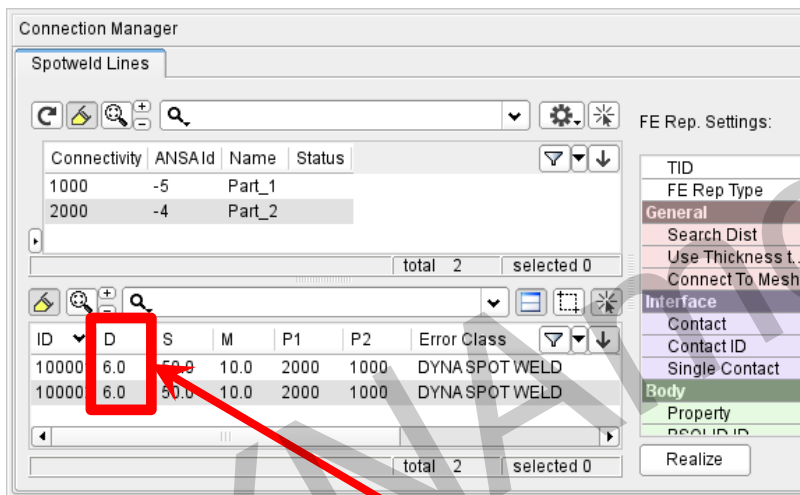

ANSA Parameter

Design Variable (weld spot diameter) = 3.0

ANSA – Optimization Task

Simulation & DOE

- Checking Combinations of DV (Full Factorial) → Model Validity
- Checking Element Criteria

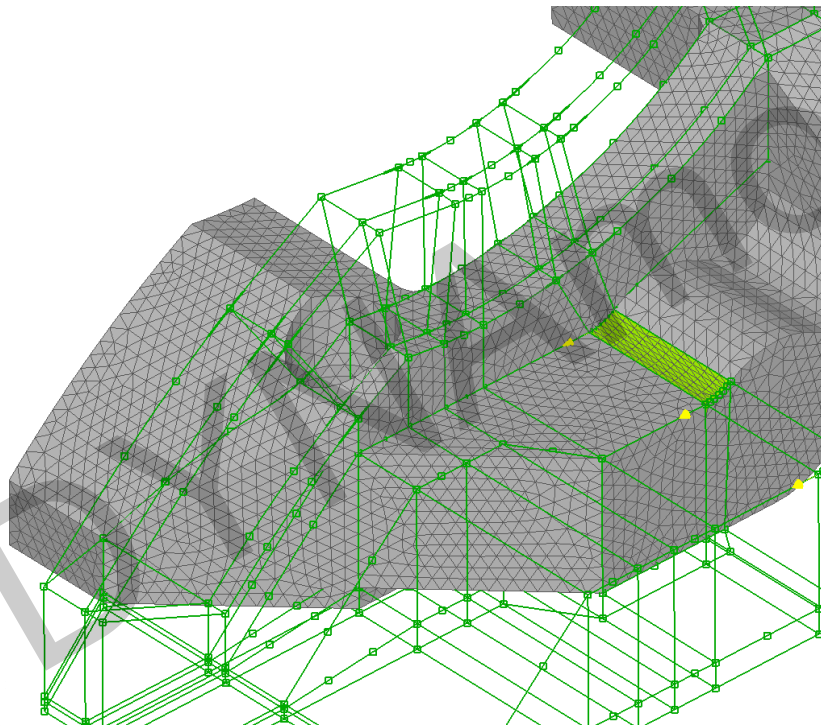

Simulate and DOE

Id	Name	Range	Min	Max
3	DV_Hoehe_Mittelsteg	Bounds	-5.	12.
2	DV_Breite_Seitensteg	Bounds	0.	10.
1	DV_Breite_Flachsteg_oben	Bounds	0.	20.
6	DV_Breite_Flachsteg_unten	Bounds	0.	25.
9	DV_Hoehe_Nase	Bounds	0.	10.
4	DV_Breite_Mittelsteg_ob_au	Bounds	-20.	13.
7	DV_Breite_Mittelsteg_ob_in	Bounds	-20.	13.
5	DV_Breite_Mittelsteg_un_au	Bounds	-13.	10.
8	DV_Breite_Mittelsteg_un_in	Bounds	-13.	10.
10	DV_Breite_Nase	Bounds	0.	20.

	DV_Breit	DV_Brei					
1	0.	0.					
2	2.	5.					
3	4.	10.					
4	6.	15.					
5	8.	20.					
6	10.	25.					

Algorithm..
 Simulate
 Steps: 6

Simulation info

ANSA – Optimization Task

Simulation & DOE

- Checking Combinations of DV (Full Factorial) → Model Validity
- Checking Element Criteria

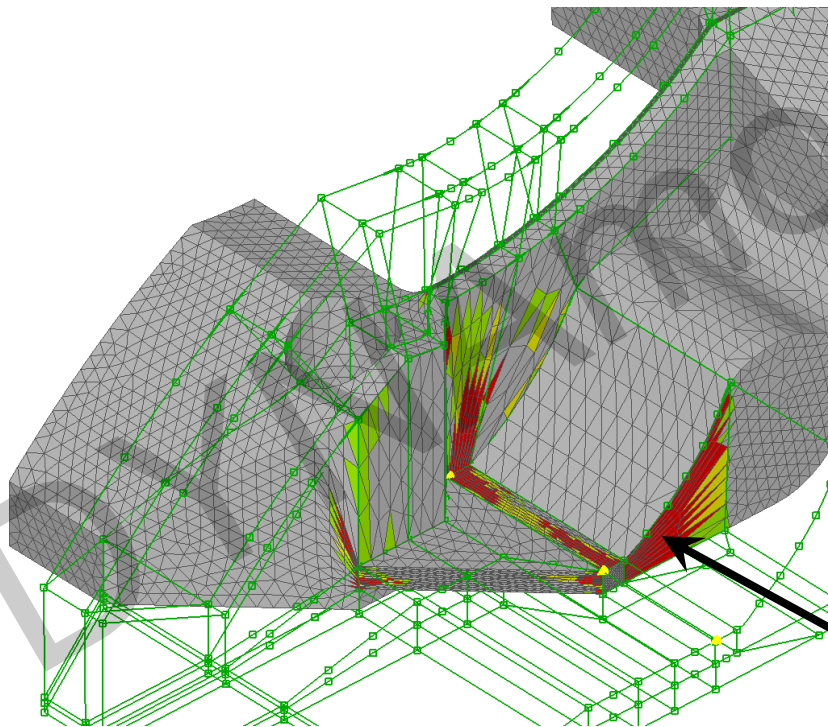

Simulate and DOE

Id	Name	Range	Min	Max
3	DV_Hoehe_Mittelsteg	Bounds	-5.	12.
2	DV_Breite_Seitensteg	Bounds	0.	10.
1	DV_Breite_Flachsteg_oben	Bounds	0.	20.
6	DV_Breite_Flachsteg_unten	Bounds	0.	25.
9	DV_Hoehe_Nase	Bounds	0.	10.
4	DV_Breite_Mittelsteg_ob_au	Bounds	-20.	13.
7	DV_Breite_Mittelsteg_ob_in	Bounds	-20.	13.
5	DV_Breite_Mittelsteg_un_au	Bounds	-13.	10.
8	DV_Breite_Mittelsteg_un_in	Bounds	-13.	10.
10	DV_Breite_Nase	Bounds	0.	20.

	DV_Breit	DV_Brei							
1	0.	0.							
2	2.	5.							
3	4.	10.							
4	6.	15.							
5	8.	20.							
6	10.	25.							

Simulate ▾ Run Task Experiments ▾ Clear table

Algorithm..
Simulate ▾
Generate Steps: 6

Simulation info

Failed elements

ANSA – Optimization Task

Additional commands for improving mesh quality

Fix Quality, Smooth, Reconstruct, etc. for morphed mesh

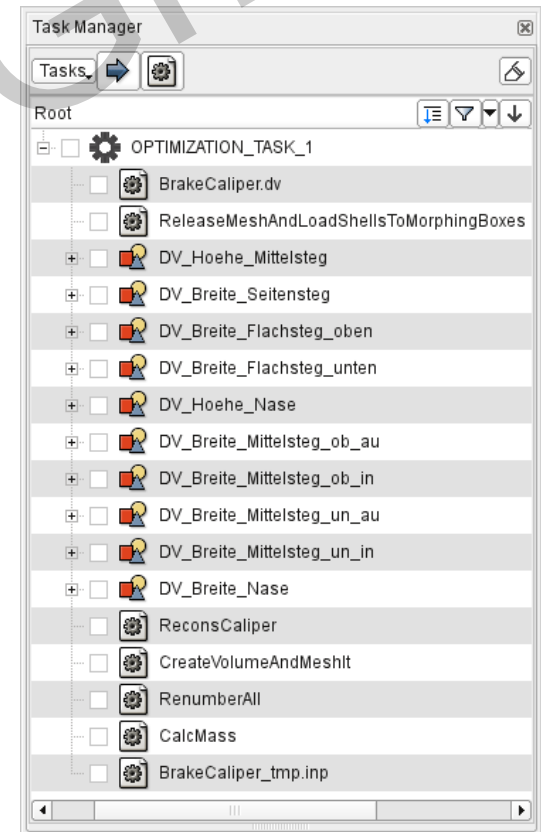
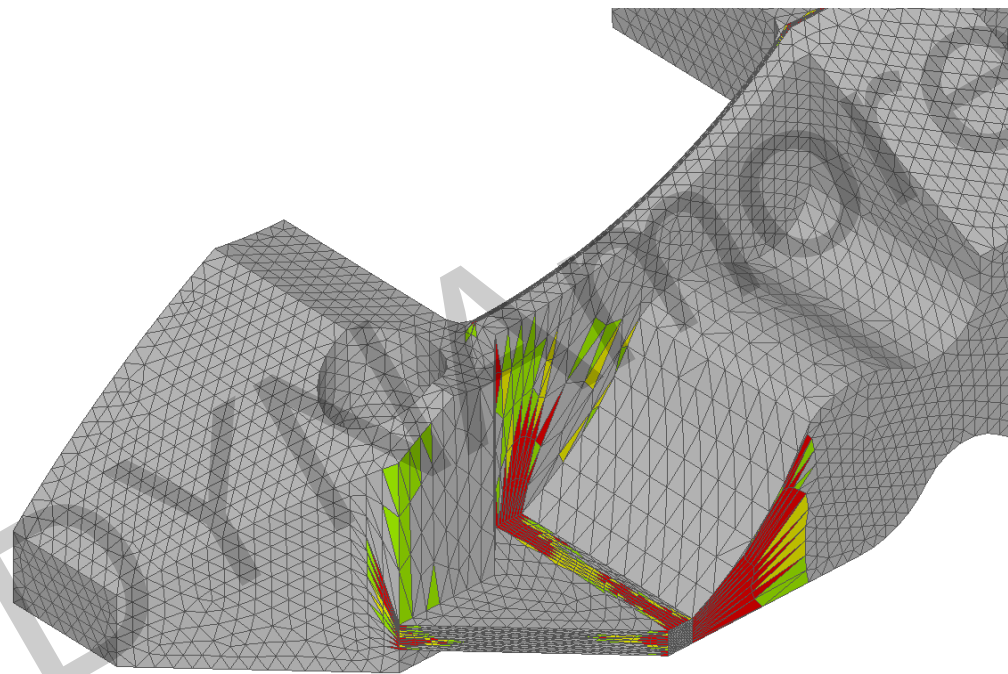

ANSA – Optimization Task

Additional commands for improving mesh quality

Fix Quality, Smooth, Reconstruct, etc. for morphed mesh

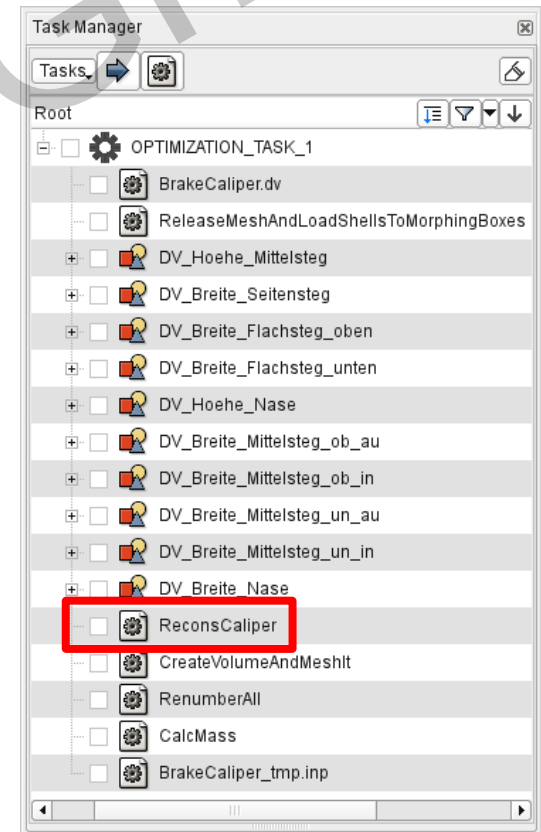
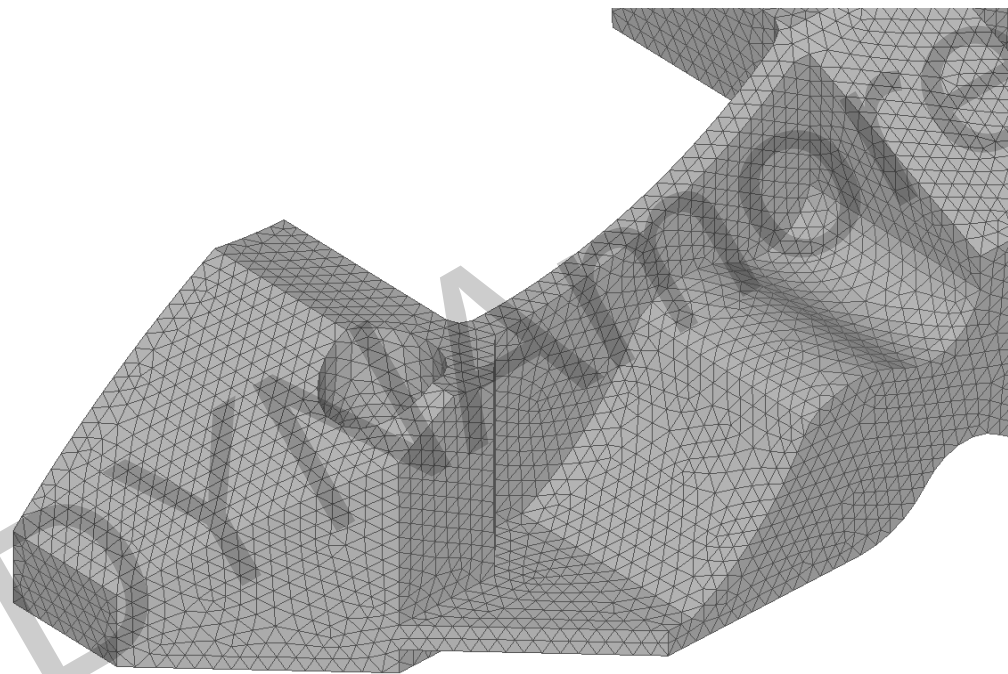

μETA – OptimizerSetup Toolbar

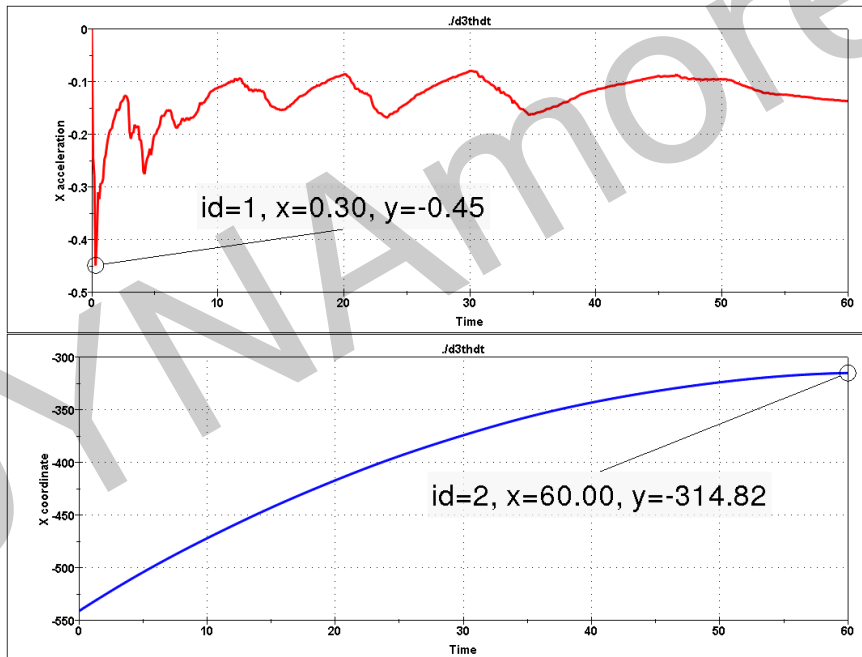

The "OptimizerSetup" dialog box is shown on the right side of the image. It is divided into two main sections: "Response Variables" and "History Variables".

Response Variables Section:

- Responses: A dropdown menu currently shows "1 acceleration".
- Buttons: "Add", "Print Response Values", "Update Response Values" (with "Current" and "All" sub-buttons), "Remove" (with "Current" and "All" sub-buttons), and "Rename Response" (with a dropdown).

History Variables Section:

- Histories: A dropdown menu.
- Buttons: "Add", "Print History Values", "Update History Values" (with "Current" and "All" sub-buttons), "Remove" (with "Current" and "All" sub-buttons), and "Rename History" (with a dropdown).

At the bottom of the dialog is an "Export Session" button. A black arrow points from the top plot to the "Add" button in the Response Variables section.

μ ETA – OptimizerSetup Toolbar

- Responses from annotations, variables, advanced expressions

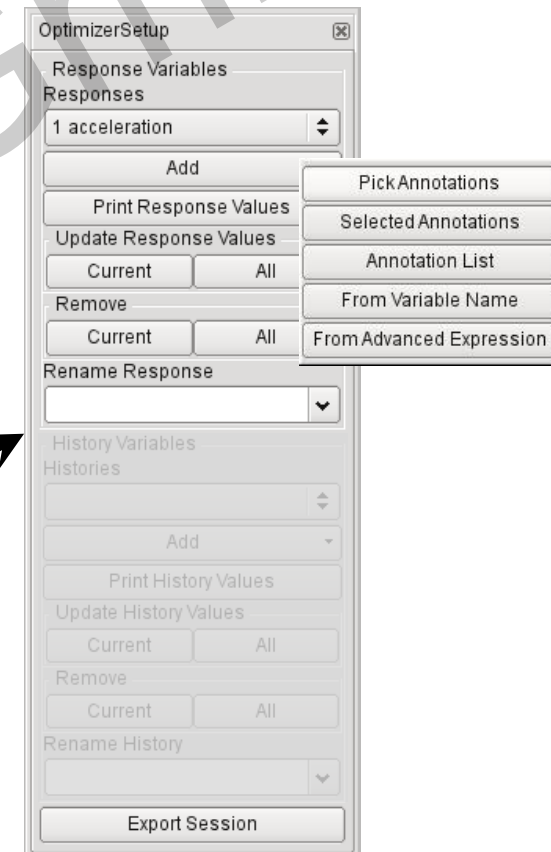
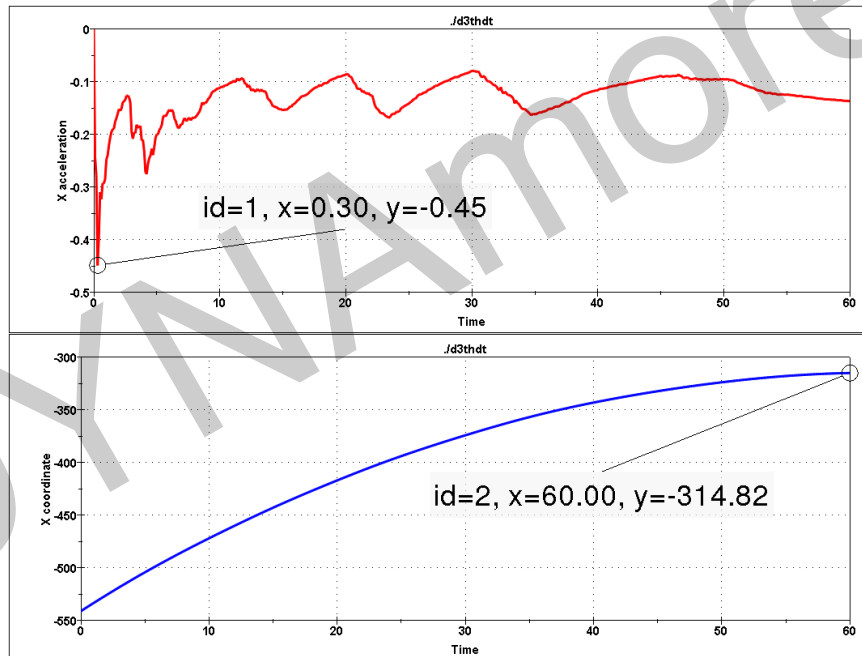

μ ETA – OptimizerSetup Toolbar

- Responses from annotations, variables, advanced expressions
- Histories from 2D plot curves

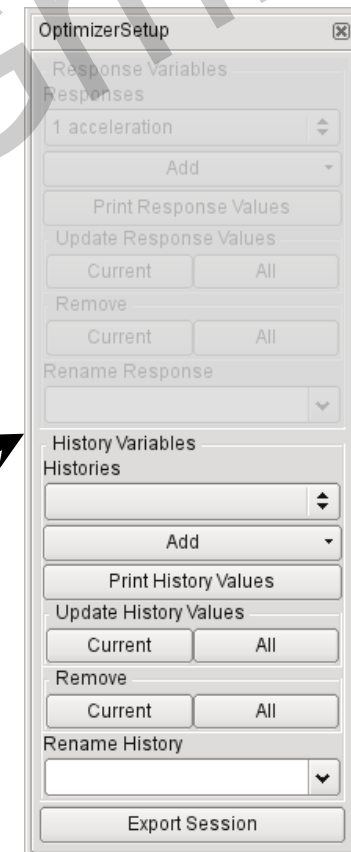
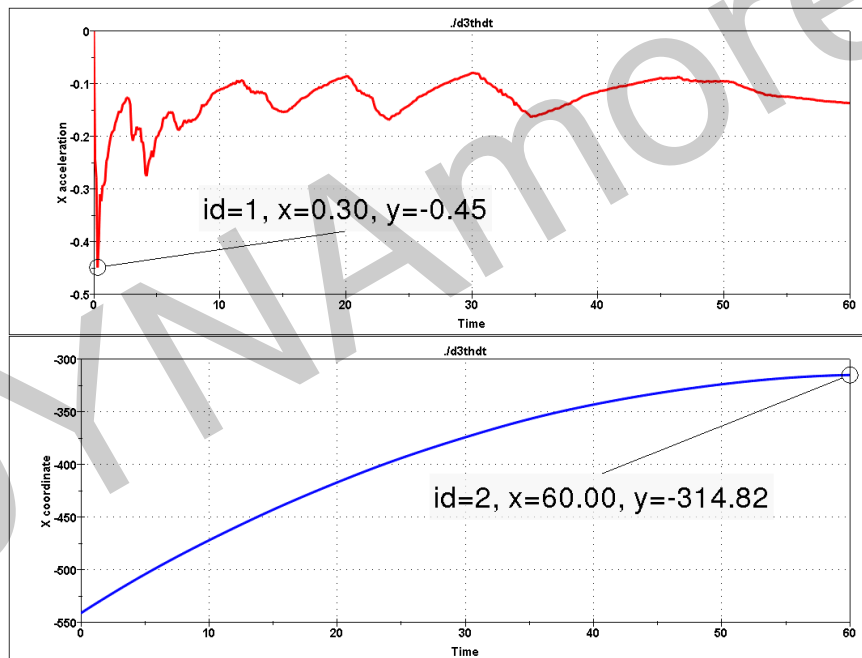

μETA – OptimizerSetup Toolbar

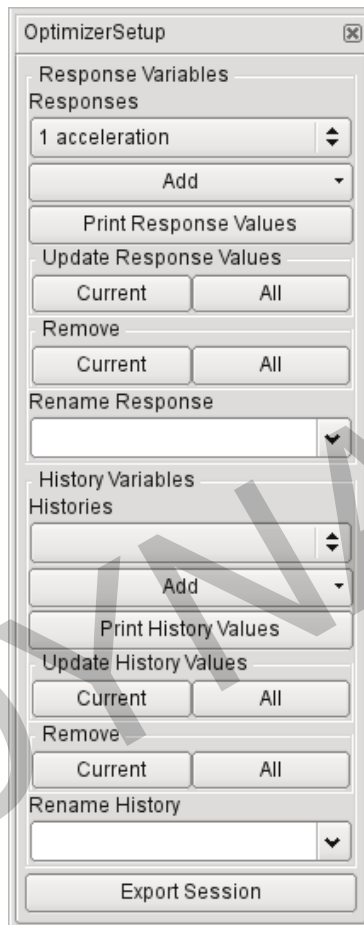

μETA – OptimizerSetup Toolbar

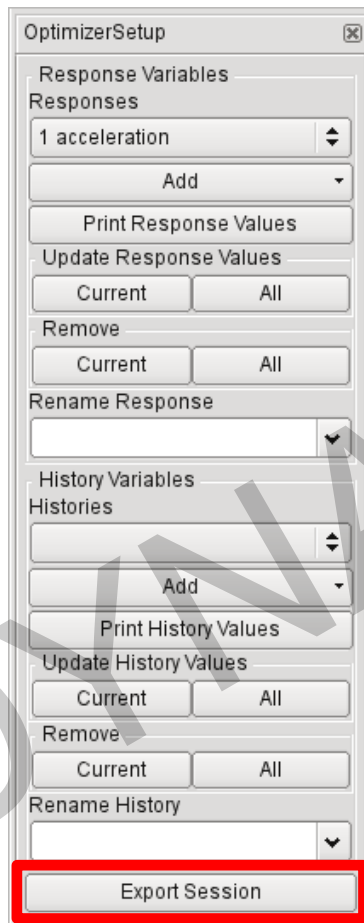

Exports:

- Session file (for reproduction of results extraction)
- Output file, containing responses and histories

```
#OptimizerSetup Response & history File created by META post  
RESPONSES  
1, acceleration, -1.18  
2, intrusion, -440.07  
END
```

Correctly formatted for
import in LS-OPT

Connecting ANSA to LS-OPT

DYNAMORE GmbH

Connecting ANSA to LS-OPT

Stage for ANSA

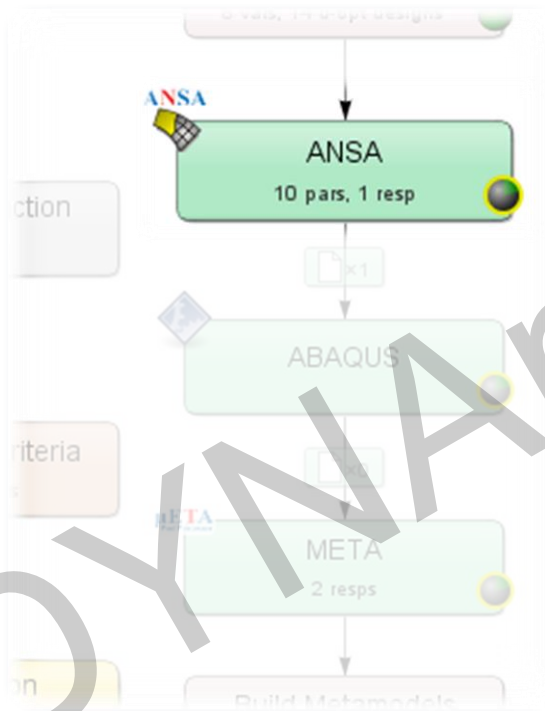

Connecting ANSA to LS-OPT

Stage for ANSA

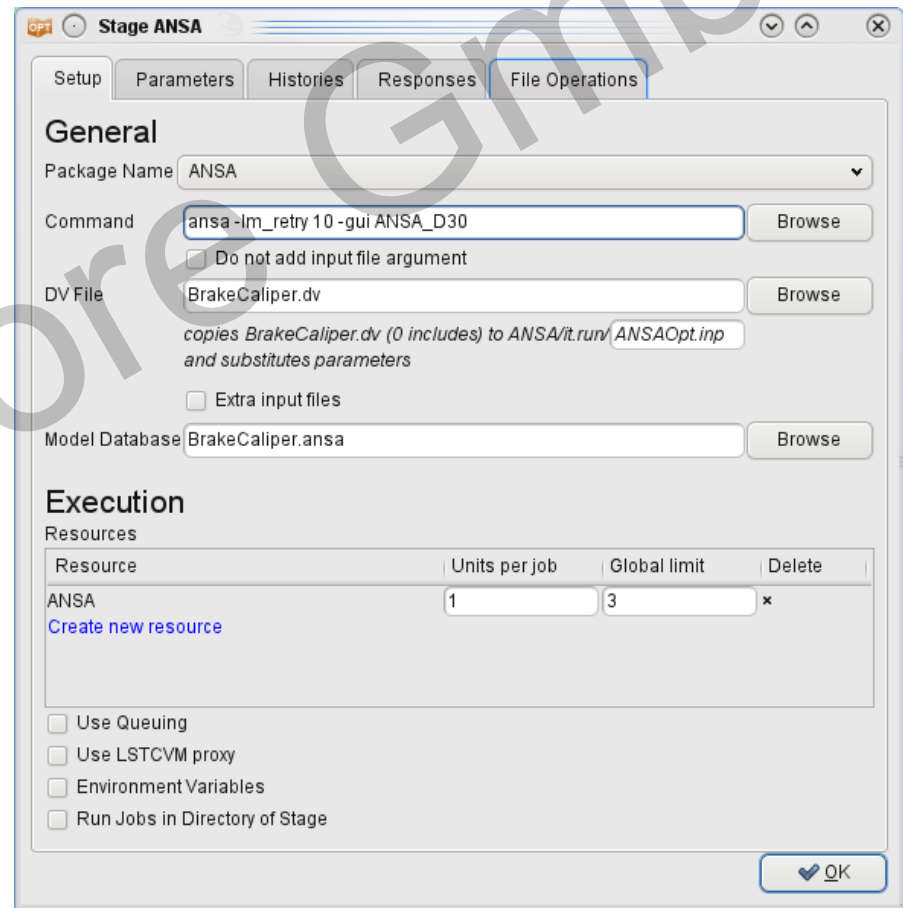
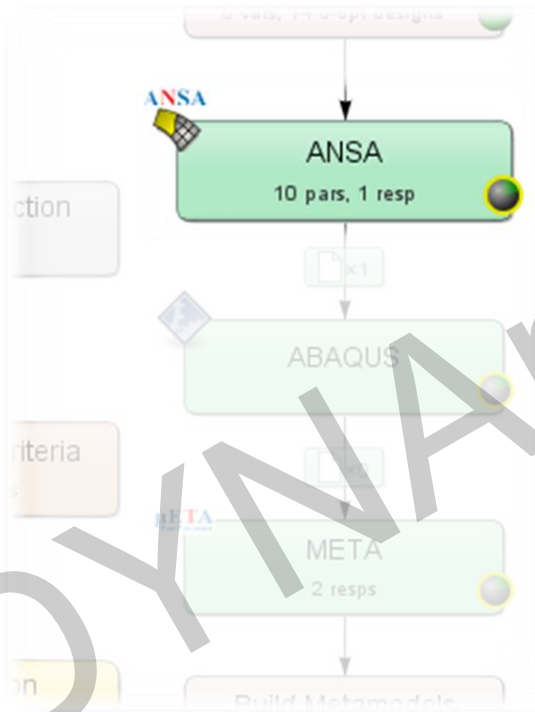

Connecting ANSA to LS-OPT

Stage for ANSA

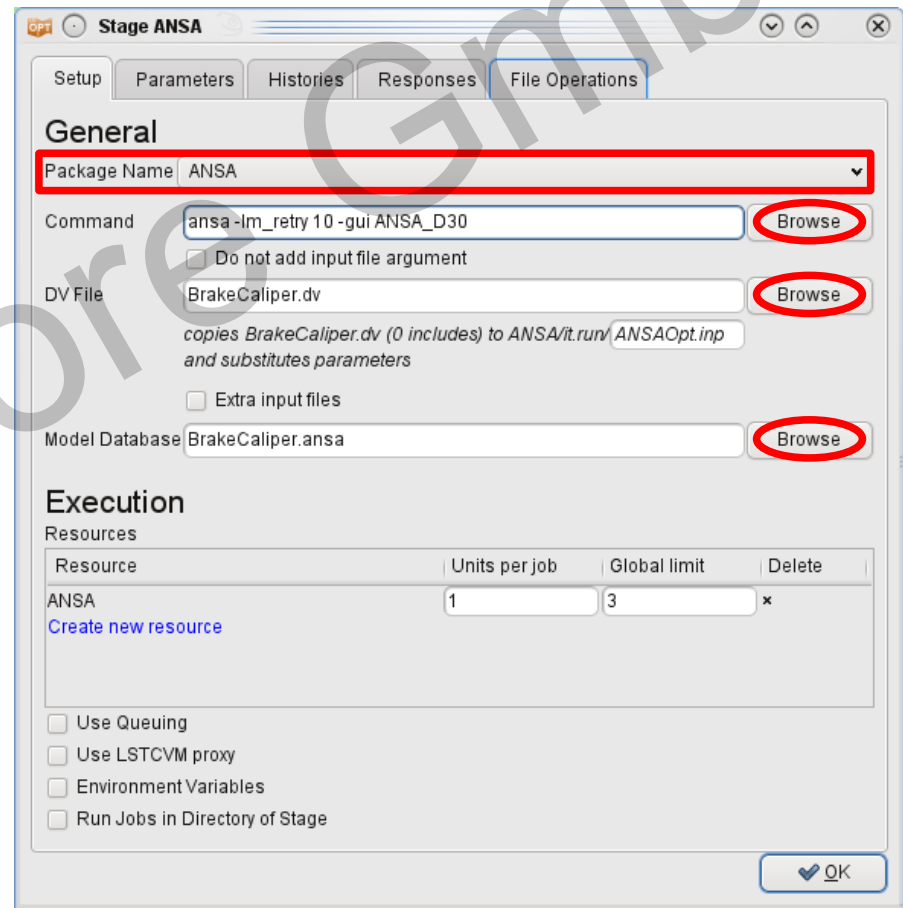
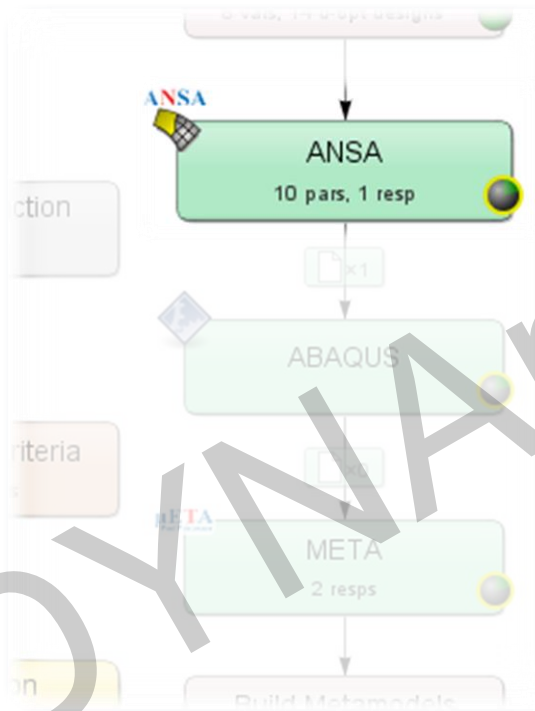

Connecting ANSA to LS-OPT

ANSA → DV file → Design Variables in LS-OPT

```
#
# ANSA_VERSION: 15.0.1
#
# file created by ANSA Fri Feb 14 15:49:00 2014
#
# Output from:
# ansaout.ansa
#
# DESIGN VARIABLES
#-----
# ID | DESIGN VARIABLE NAME | TYPE | RANGE | CURRENT VA
#-----
3, DV_Hoehe_Mittelsteg, REAL, BOUNDS, 0., -5.
2, DV_Breite_Seitensteg, REAL, BOUNDS, 0., -5.
1, DV_Breite_Flachsteg_oben, REAL, BOUNDS, 0., 0.
6, DV_Breite_Flachsteg_unten, REAL, BOUNDS, 0., 0.
9, DV_Hoehe_Nase, REAL, BOUNDS, 0., 0., 10.
4, DV_Breite_Mittelsteg_ob_au, REAL, BOUNDS, 0., 0.
7, DV_Breite_Mittelsteg_ob_in, REAL, BOUNDS, 0., 0.
5, DV_Breite_Mittelsteg_un_au, REAL, BOUNDS, 0., 0.
8, DV_Breite_Mittelsteg_un_in, REAL, BOUNDS, 0., 0.
10, DV_Breite_Nase, REAL, BOUNDS, 0., 0., 20.
#-----
```

Parameter Setup Stage Matrix Sampling Matrix Resources Features

Show advanced options

Type	Name	Starting	Init. Range	Minimum	Maximum
Continuous	DV_Breite_Flachsteg_oben	0		0	15
Continuous	DV_Breite_Flachsteg_unten	0		0	25
Continuous	DV_Breite_Mittelsteg_ob_au	0		0	13
Continuous	DV_Breite_Mittelsteg_ob_in	10		-20	13
Continuous	DV_Breite_Mittelsteg_un_au	0		0	10
Continuous	DV_Breite_Mittelsteg_un_in	5		-13	10
Continuous	DV_Breite_Nase	0		0	20
Continuous	DV_Breite_Seitensteg	0		-5	10
Continuous	DV_Hoehe_Mittelsteg	0		-5	12
Continuous	DV_Hoehe_Nase	0		0	10

← Add... →

OK

Connecting ANSA to LS-OPT

Fine Tuning of Design Variables, e.g.

Type	Name	Starting	Init. Range	Minimum	Maximum
Continuous	DV_Breite_Flachsteg_oben	0	8	0	15
Continuous	DV_Breite_Flachsteg_unten	0	12	0	25
Continuous	DV_Breite_Mittelsteg_ob_au	0	6	0	13
Dependent	DV_Breite_Mittelsteg_ob_in	Definition: DV_Breite_Mittelsteg_ob_au			
Continuous	DV_Breite_Mittelsteg_un_au	0	5	0	10
Dependent	DV_Breite_Mittelsteg_un_in	Definition: DV_Breite_Mittelsteg_un_au			
Continuous	DV_Breite_Nase	0	10	0	20
Continuous	DV_Breite_Seitensteg	0	8	-5	10
Continuous	DV_Hoehe_Mittelsteg	0	8	-5	12
Continuous	DV_Hoehe_Nase	0	5	0	10

Connecting ANSA to LS-OPT

Fine Tuning of Design Variables, e.g.

- Ranges

Type	Name	Starting	Init. Range	Minimum	Maximum
Continuous	DV_Breite_Flachsteg_oben	0	8	0	15
Continuous	DV_Breite_Flachsteg_unten	0	12	0	25
Continuous	DV_Breite_Mittelsteg_ob_au	0	6	0	13
Dependent	DV_Breite_Mittelsteg_ob_in	Definition:	DV_Breite_Mittelsteg_ob_au		
Continuous	DV_Breite_Mittelsteg_un_au	0	5	0	10
Dependent	DV_Breite_Mittelsteg_un_in	Definition:	DV_Breite_Mittelsteg_un_au		
Continuous	DV_Breite_Nase	0	10	0	20
Continuous	DV_Breite_Seitensteg	0	8	-5	10
Continuous	DV_Hoehe_Mittelsteg	0	8	-5	12
Continuous	DV_Hoehe_Nase	0	5	0	10

Add...

OK

Connecting ANSA to LS-OPT

Fine Tuning of Design Variables, e.g.

- Ranges
- Dependencies
- etc.

The screenshot shows the 'Parameter Setup' dialog box in ANSA. It has tabs for 'Parameter Setup', 'Stage Matrix', 'Sampling Matrix', 'Resources', and 'Features'. The 'Parameter Setup' tab is active, and 'Show advanced options' is checked. The dialog displays a table of design variables with columns for Type, Name, Starting, Init. Range, Minimum, and Maximum. Two rows are highlighted with red boxes, indicating dependencies: 'DV_Breite_Mittelsteg_ob_in' depends on 'DV_Breite_Mittelsteg_ob_au', and 'DV_Breite_Mittelsteg_un_in' depends on 'DV_Breite_Mittelsteg_un_au'. At the bottom, there is an 'Add...' button and an 'OK' button.

Type	Name	Starting	Init. Range	Minimum	Maximum
Continuous	DV_Breite_Flachsteg_oben	0	8	0	15
Continuous	DV_Breite_Flachsteg_unten	0	12	0	25
Continuous	DV_Breite_Mittelsteg_ob_au	0	6	0	13
Dependent	DV_Breite_Mittelsteg_ob_in	Definition: DV_Breite_Mittelsteg_ob_au			
Continuous	DV_Breite_Mittelsteg_un_au	0	5	0	10
Dependent	DV_Breite_Mittelsteg_un_in	Definition: DV_Breite_Mittelsteg_un_au			
Continuous	DV_Breite_Nase	0	10	0	20
Continuous	DV_Breite_Seitensteg	0	8	-5	10
Continuous	DV_Hoehe_Mittelsteg	0	8	-5	12
Continuous	DV_Hoehe_Nase	0	5	0	10

Connecting μ ETA to LS-OPT

DYNAMORE GmbH

Connecting μ ETA to LS-OPT

Stage for μ ETA

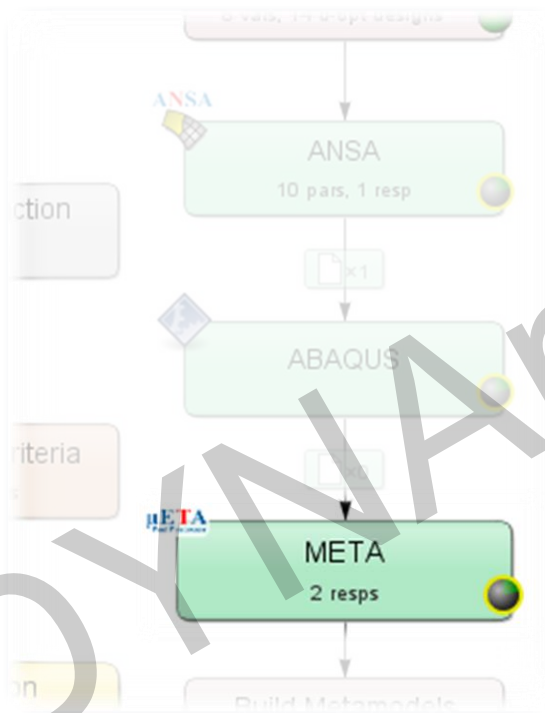

Connecting μ ETA to LS-OPT

Stage for μ ETA

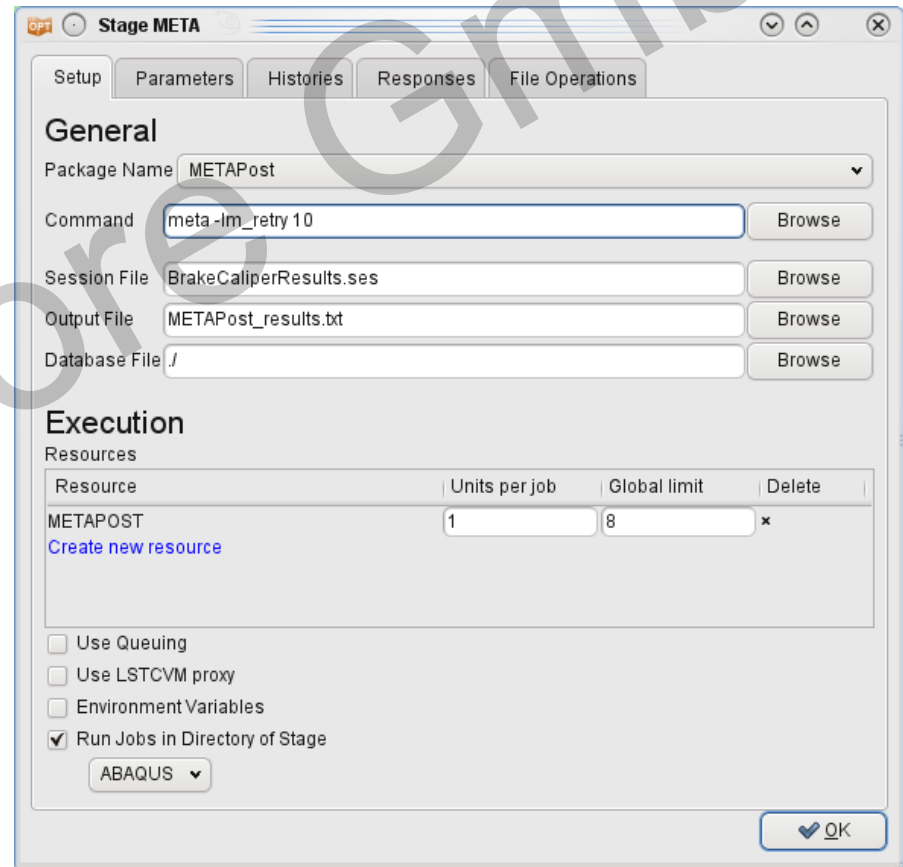
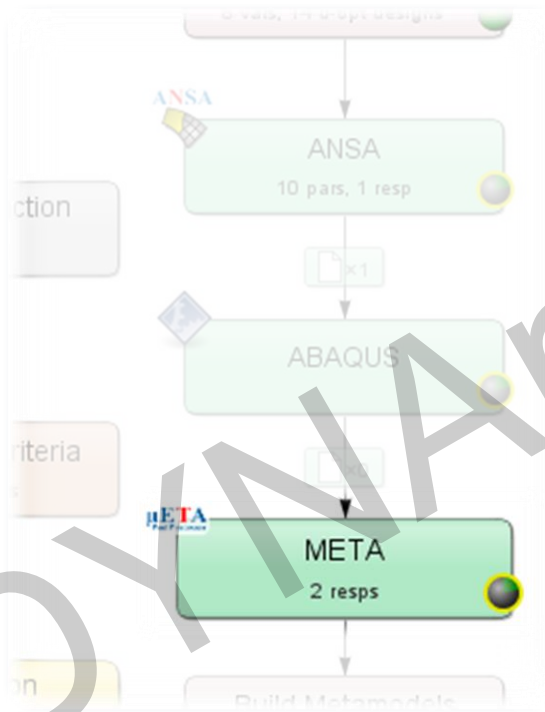

Connecting μ ETA to LS-OPT

Stage for μ ETA

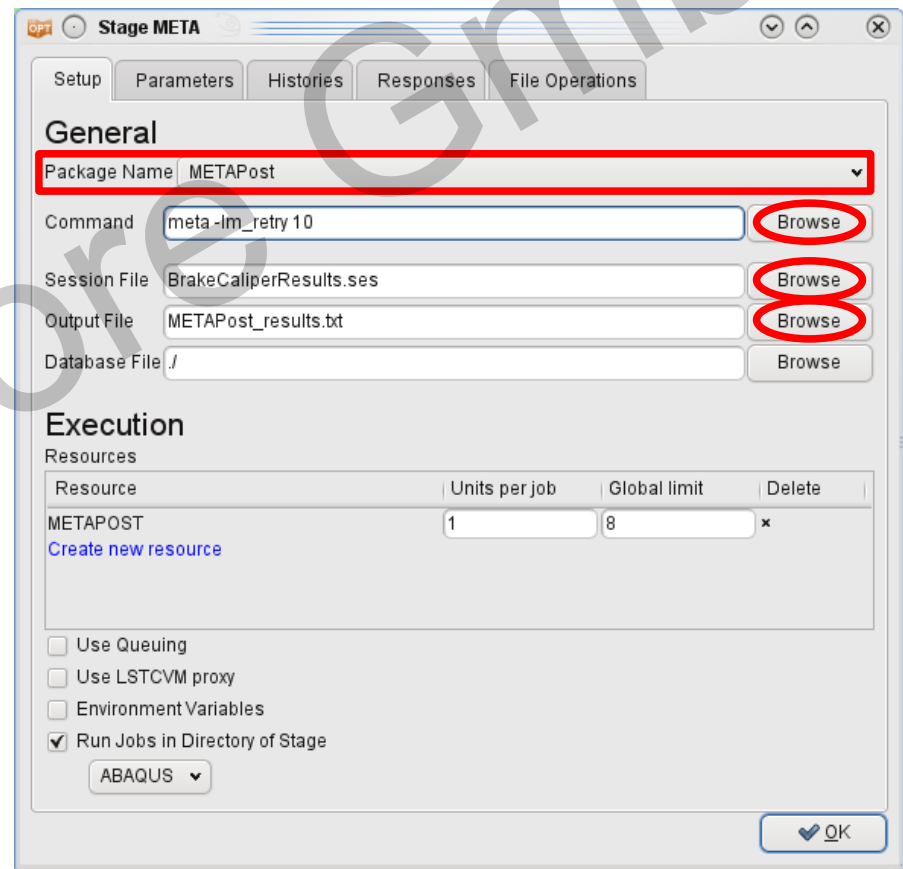
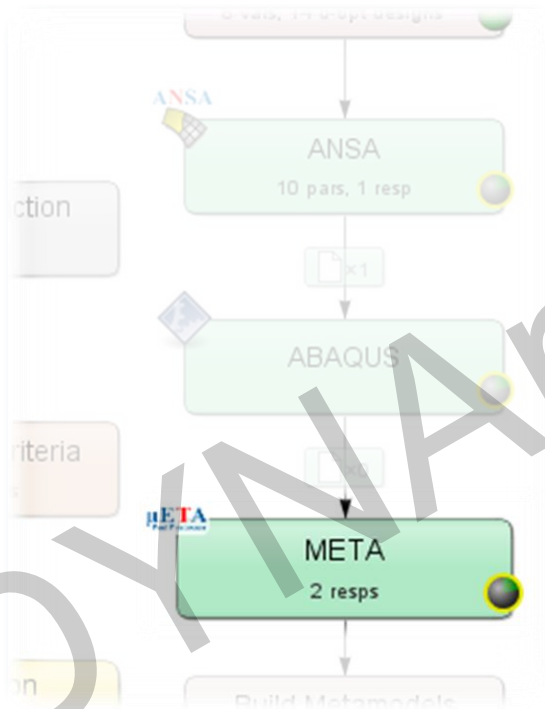

Connecting μ ETA to LS-OPT

μ ETA → Output file → Responses and Histories in LS-OPT

```
#OptimizerSetup Response & history File created by META post
RESPONSES
 1,nodes_rel_disp,0.174171448
 2,max_stress,169.780731
END
```

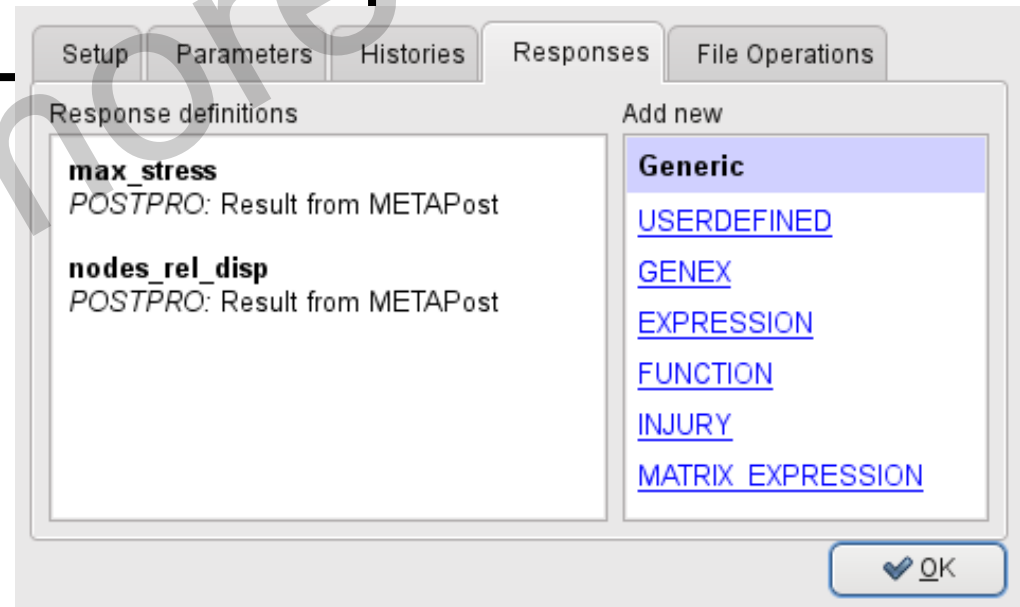

Optimization Run

LS-OPT → ANSA → Solver → META → LS-OPT

LS-OPT determines set of DV and outputs DV file

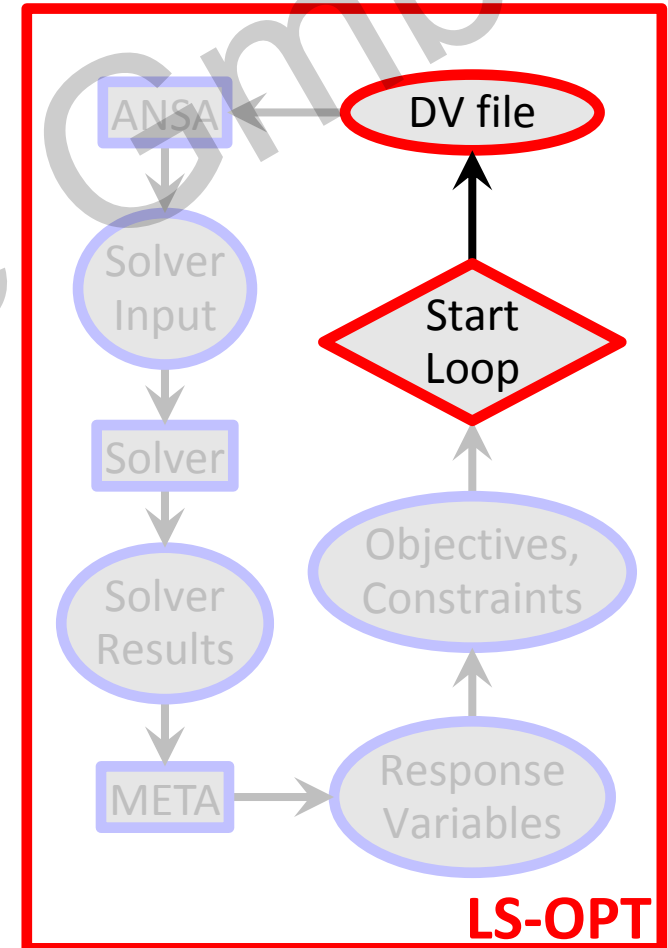

Optimization Run

LS-OPT → ANSA → Solver → META → LS-OPT

LS-OPT determines set of DV and outputs DV file

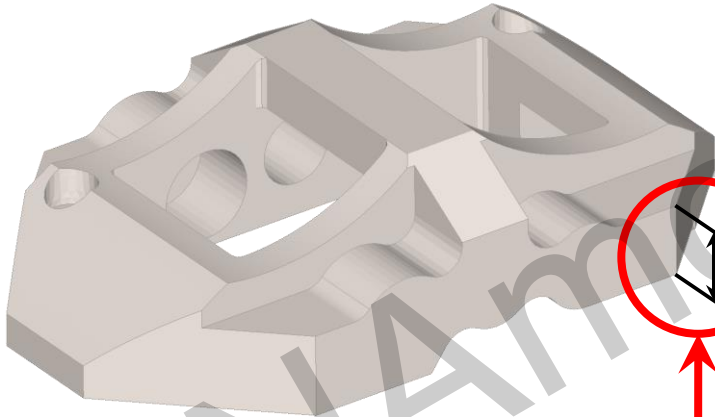

#	ID	DESIGN VARIABLE NAME	TYPE	RANGE	CURRENT VALUE	MIN VALUE
3	DV_Hoehne_Mittelsteg	REAL	BOUNDS	0., -5., 12.		
2	DV_Breite_Seitensteg	REAL	BOUNDS	0., -5., 10.		
1	DV_Breite_Flachsteg_oben	REAL	BOUNDS	0., 0., 20.		
6	DV_Breite_Flachsteg_unten	REAL	BOUNDS	0., 0., 25.		
9	DV_Hoehne_Nase	REAL	BOUNDS	0., 0., 10.		
4	DV_Breite_Mittelsteg_ob_au	REAL	BOUNDS	0., -20., 13.		
7	DV_Breite_Mittelsteg_ob_in	REAL	BOUNDS	0., -20., 13.		
5	DV_Breite_Mittelsteg_un_au	REAL	BOUNDS	0., -13., 10.		
8	DV_Breite_Mittelsteg_un_in	REAL	BOUNDS	0., -13., 10.		
10	DV_Breite_Nase	REAL	BOUNDS	0., 0., 20.		

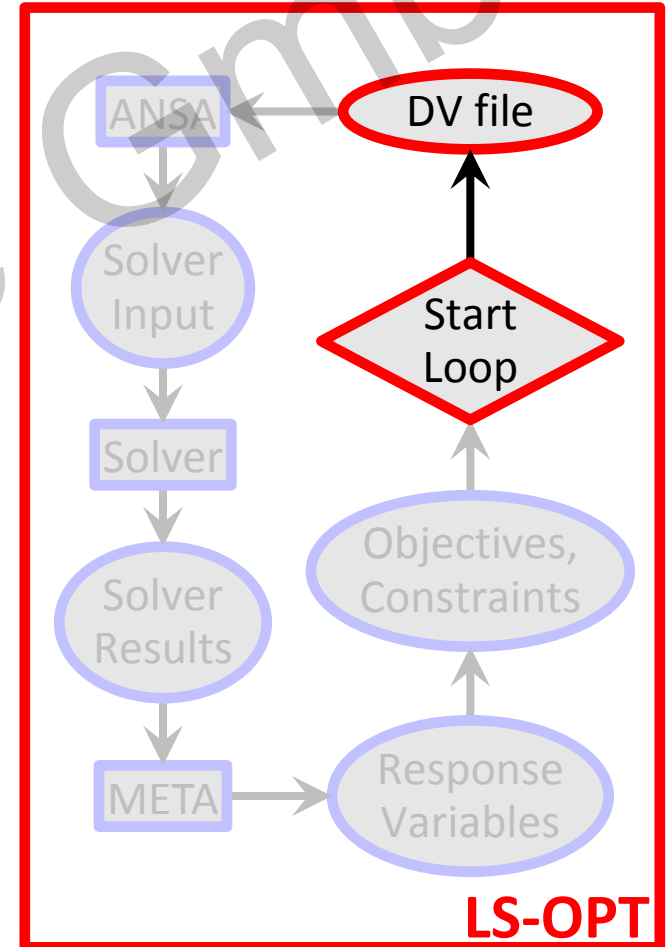

Optimization Run

LS-OPT → ANSA → Solver → META → LS-OPT

- ANSA reads DV from DV file,

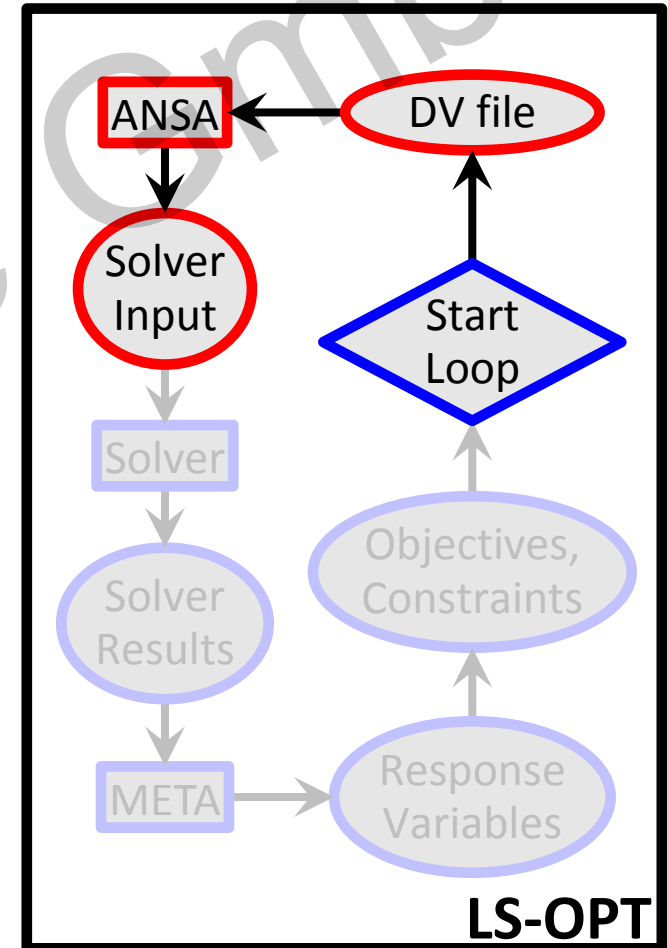

Optimization Run

LS-OPT → **ANSA** → Solver → META → LS-OPT

- ANSA reads DV from DV file,
- executes Optimization Task sequence

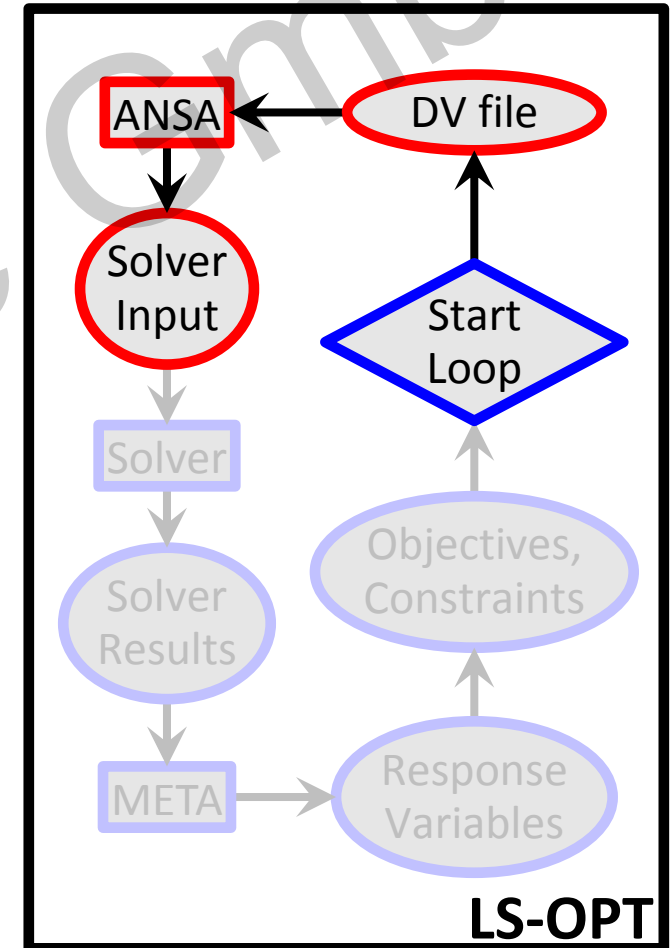
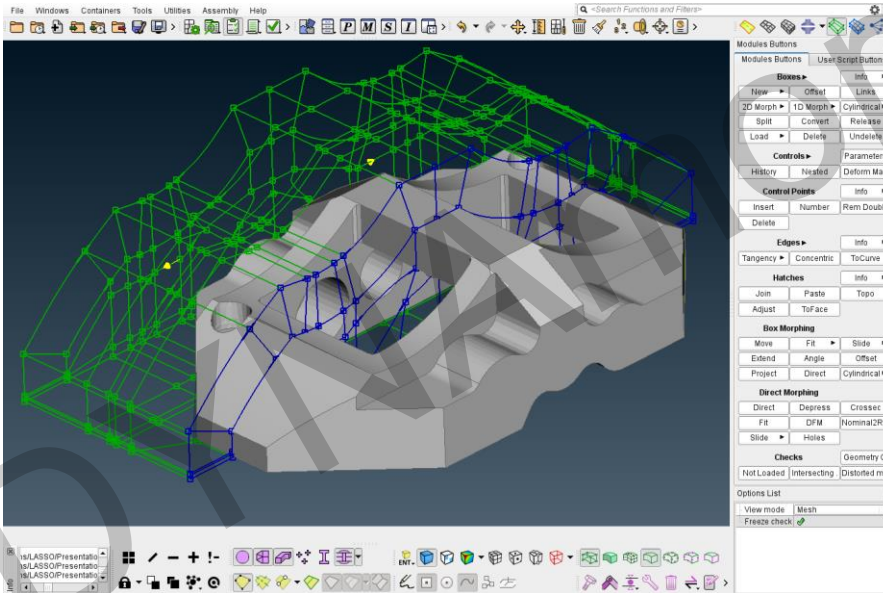

Optimization Run

LS-OPT → **ANSA** → Solver → META → LS-OPT

- ANSA reads DV from DV file,
- executes Optimization Task sequence

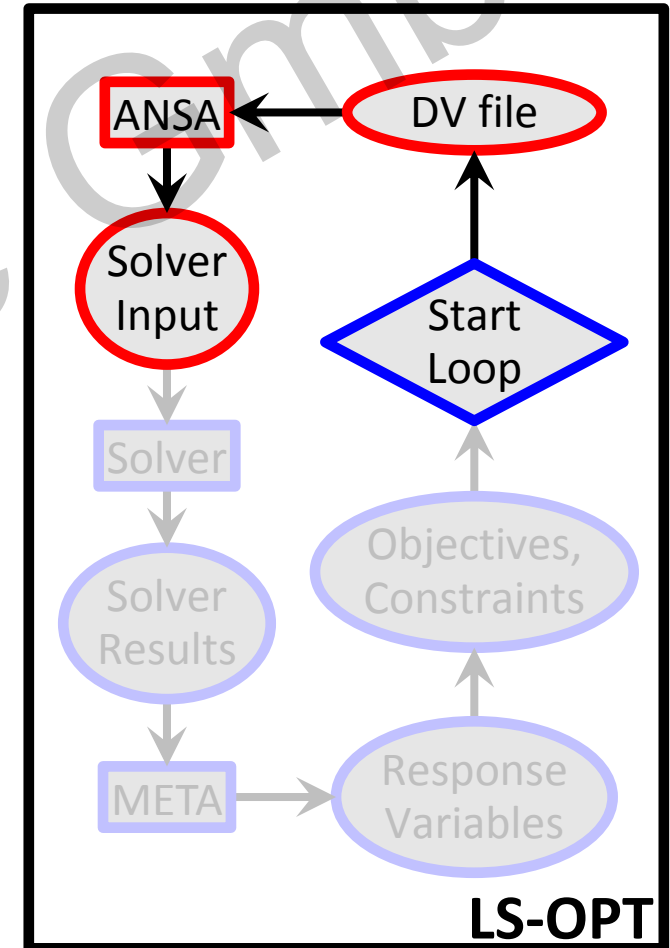
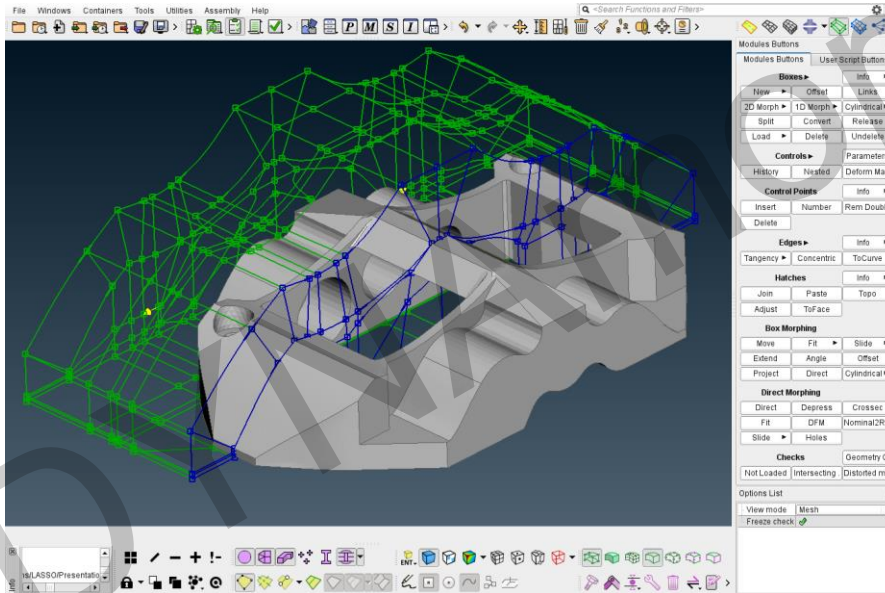

Optimization Run

LS-OPT → **ANSA** → Solver → META → LS-OPT

- ANSA reads DV from DV file,
- executes Optimization Task sequence
- and outputs solver input deck

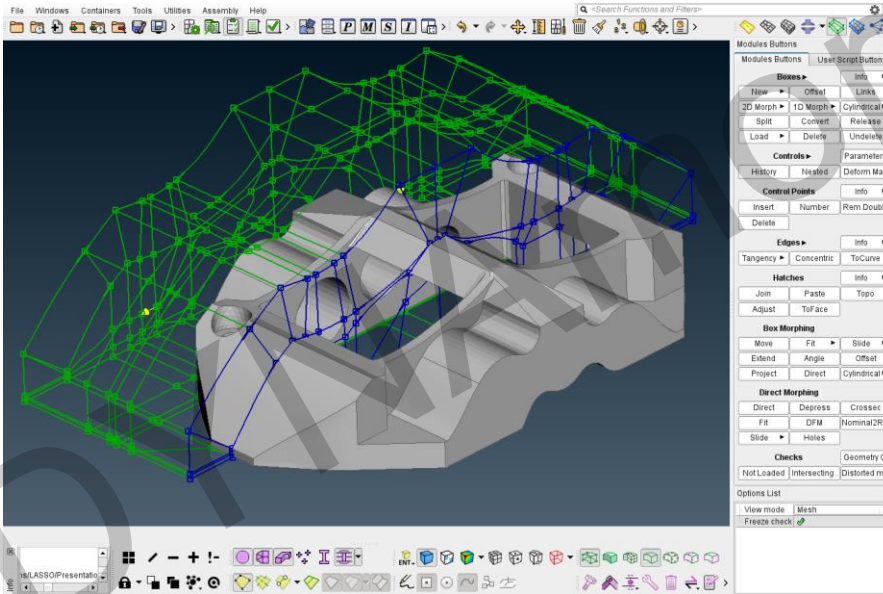

***.key / *.nas / *.inp**

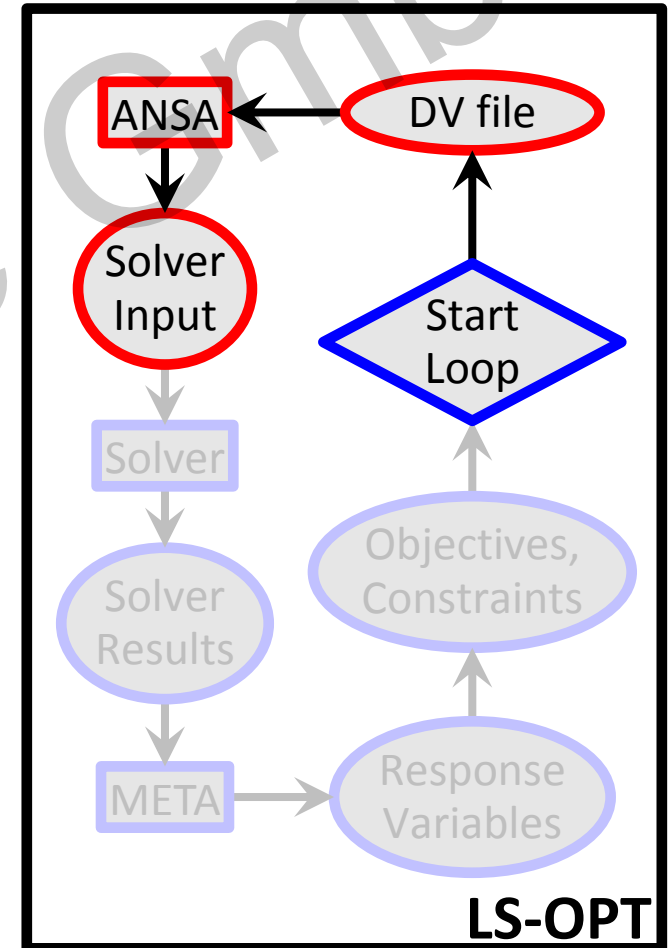

Optimization Run

LS-OPT → ANSA → **Solver** → META → LS-OPT

- LS-OPT invokes solver runs

*.key / *.nas / *.inp

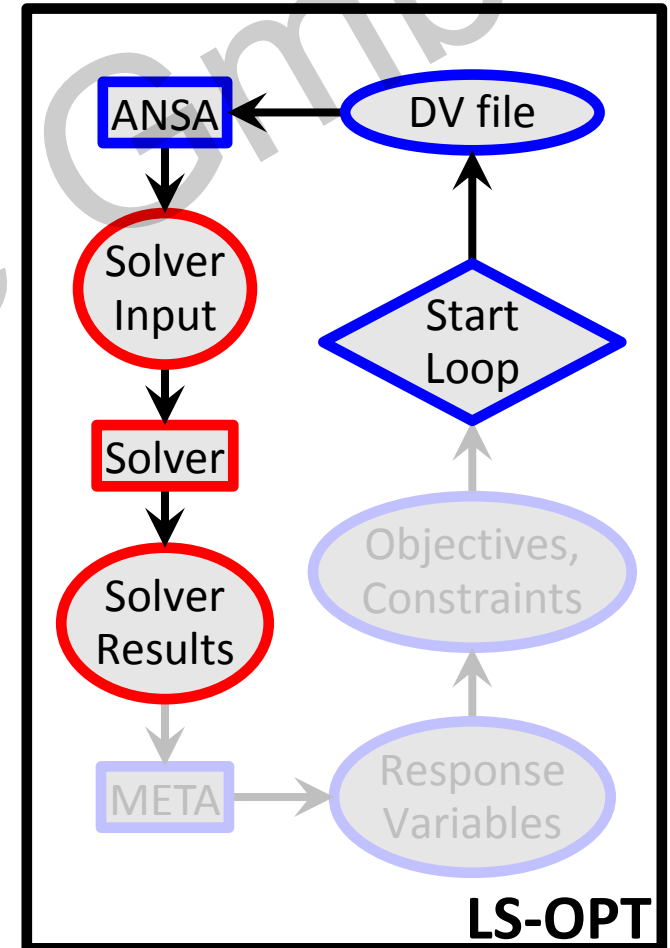
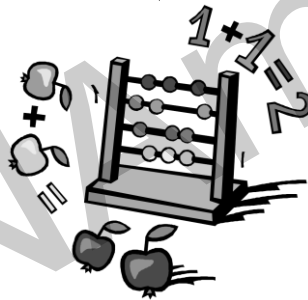

Optimization Run

LS-OPT → ANSA → **Solver** → META → LS-OPT

- LS-OPT invokes solver runs
- Solver produces result files

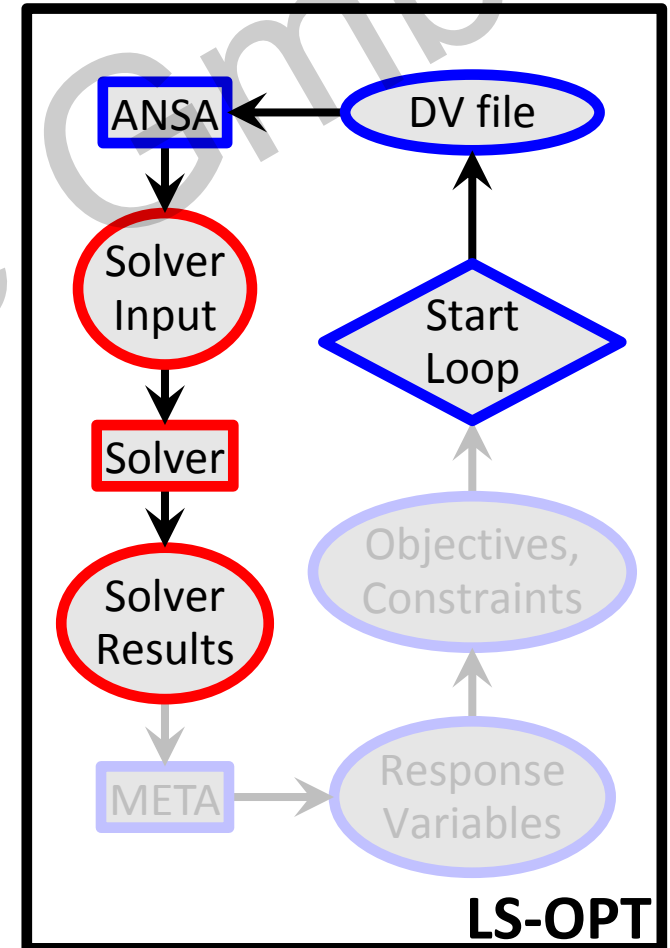
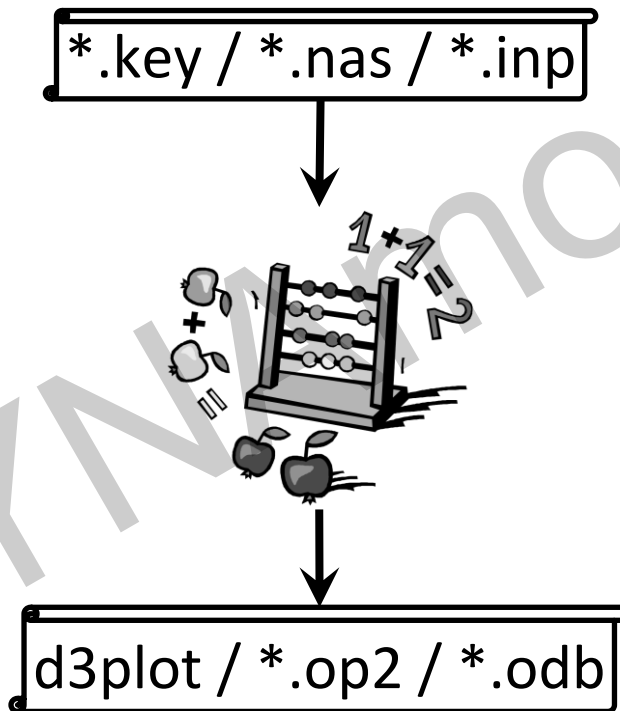

Optimization Run

LS-OPT → ANSA → Solver → **META** → LS-OPT

META extracts responses from solver result files

d3plot / *.op2 / *.odb

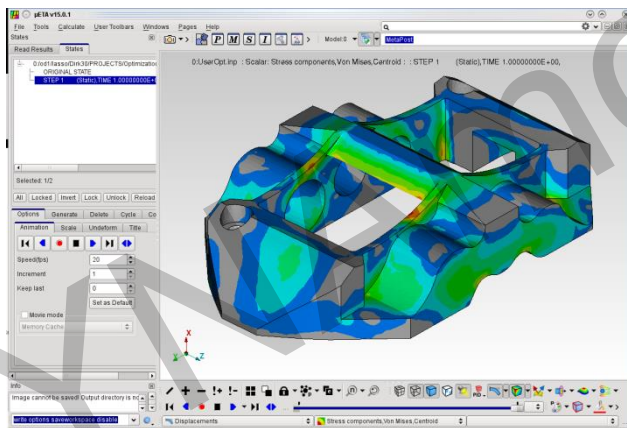

```
#OptimizerSetup Response & history File
RESPONSES
1,nodes_rel_disp,0.174171448
2,max_stress,169.780731
END
```

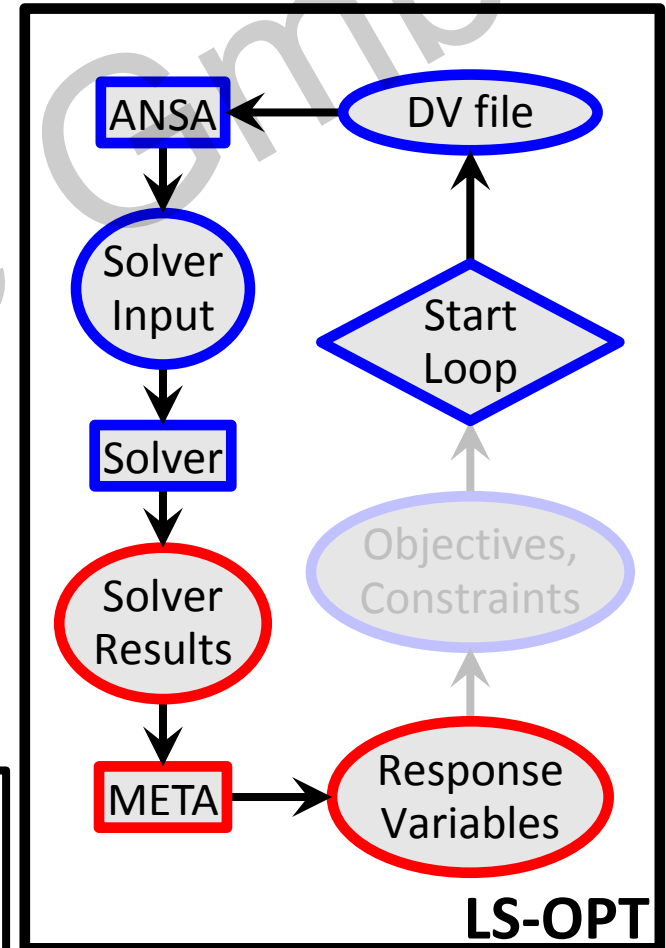

Optimization Run

LS-OPT → ANSA → Solver → META → **LS-OPT**

LS-OPT reads responses and evaluates objectives/constraints

```
#OptimizerSetup Response & history File
RESPONSES
1,nodes_rel_disp,0.174171448
2,max_stress,169.780731
END
```

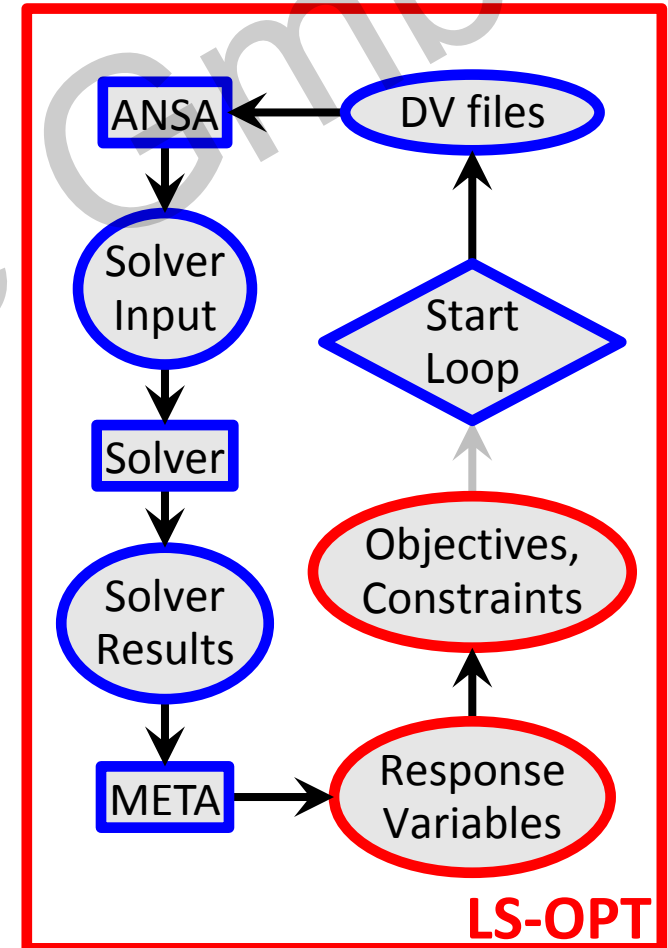
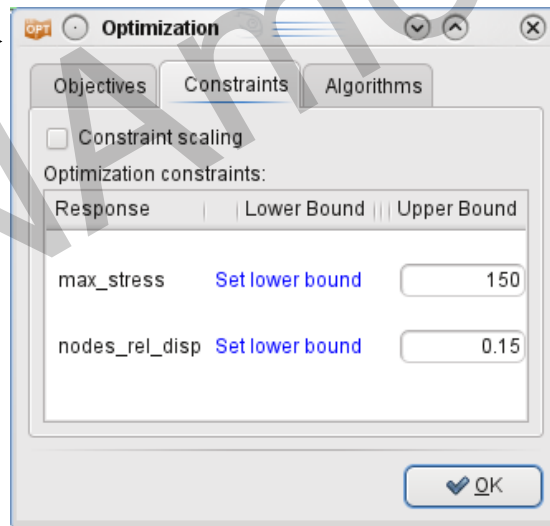

Optimization Run

LS-OPT → ANSA → Solver → META → **LS-OPT**

- LS-OPT calculates new values for DVs

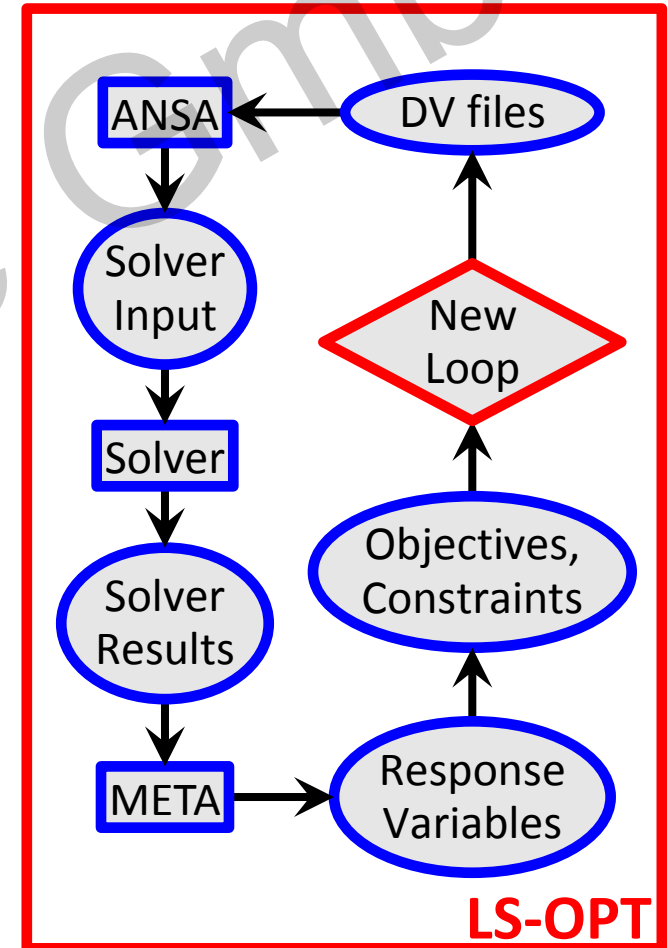

Optimization Run

LS-OPT → ANSA → Solver → META → **LS-OPT**

- LS-OPT calculates new values for DVs
- Whole process repeated until optimal solution

Initial

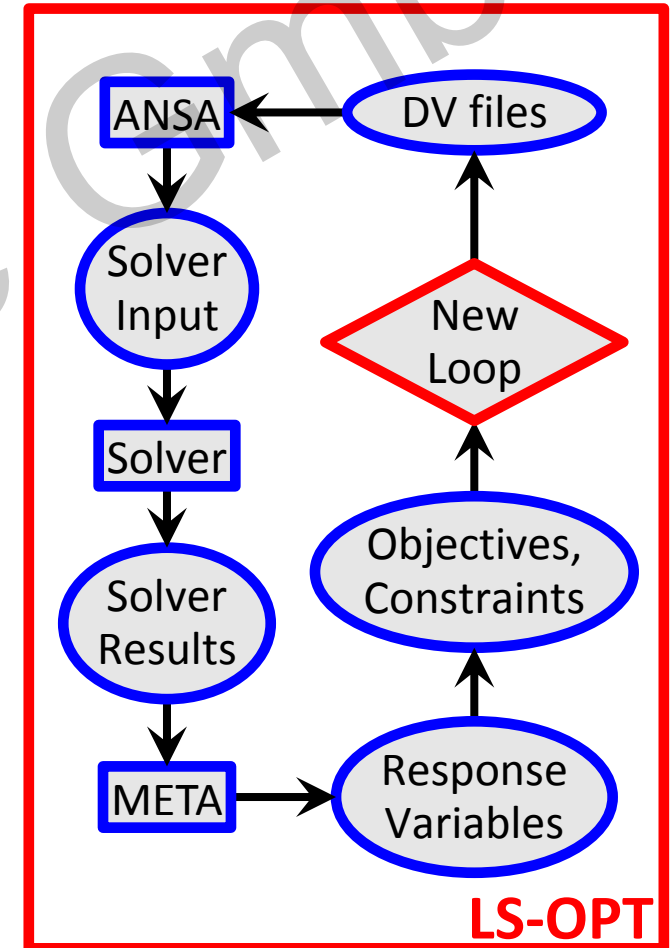
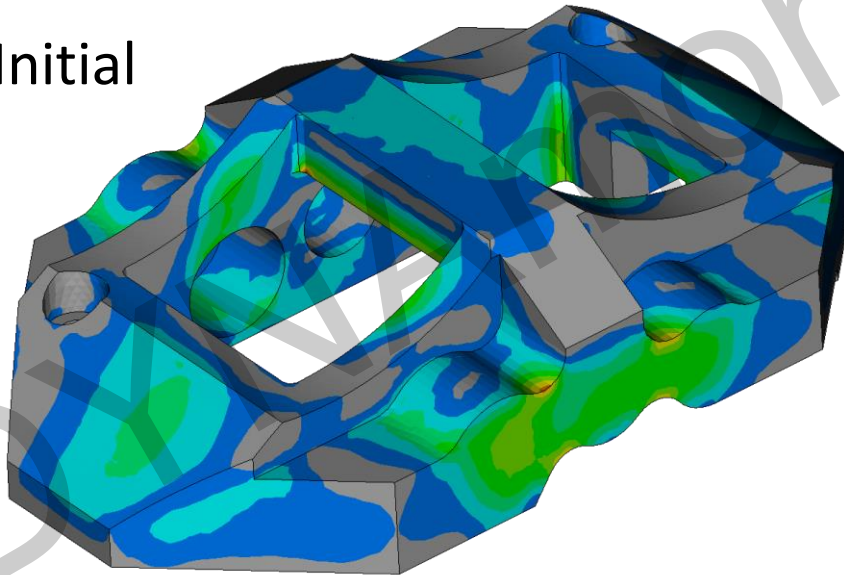

Optimization Run

LS-OPT → ANSA → Solver → META → **LS-OPT**

- LS-OPT calculates new values for DVs
- Whole process repeated until optimal solution

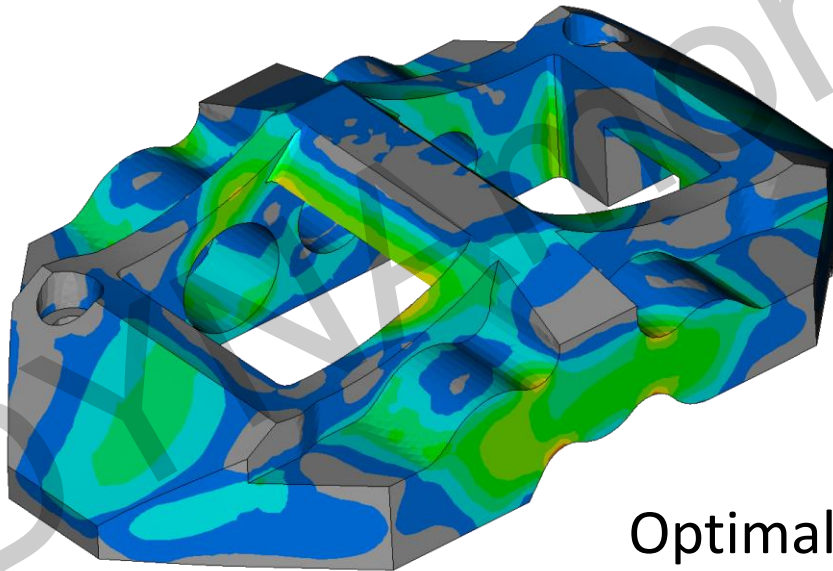

Optimal

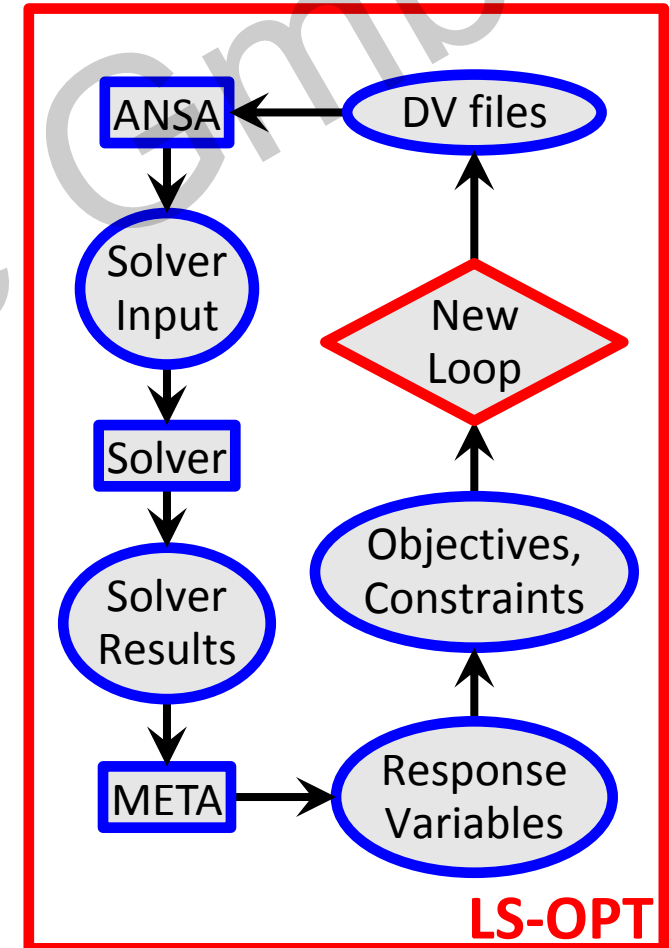

Ευχαριστώ πολύ

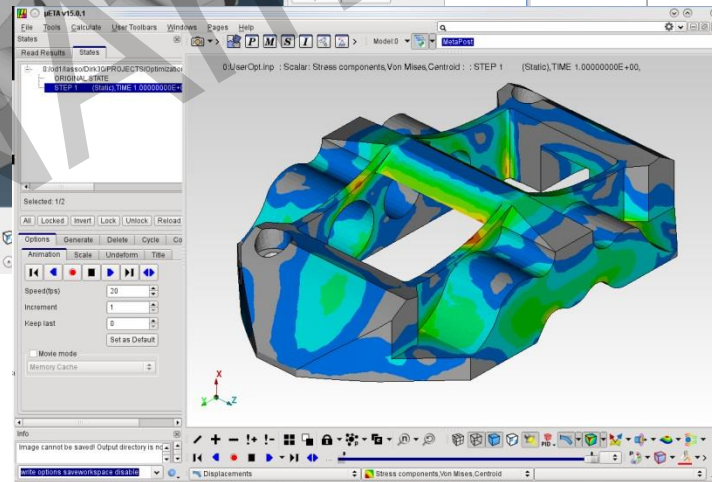
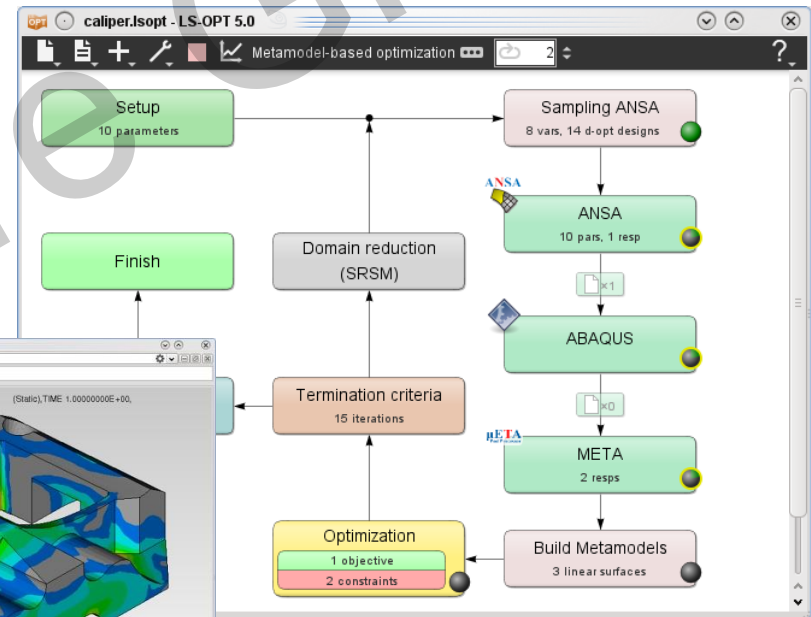
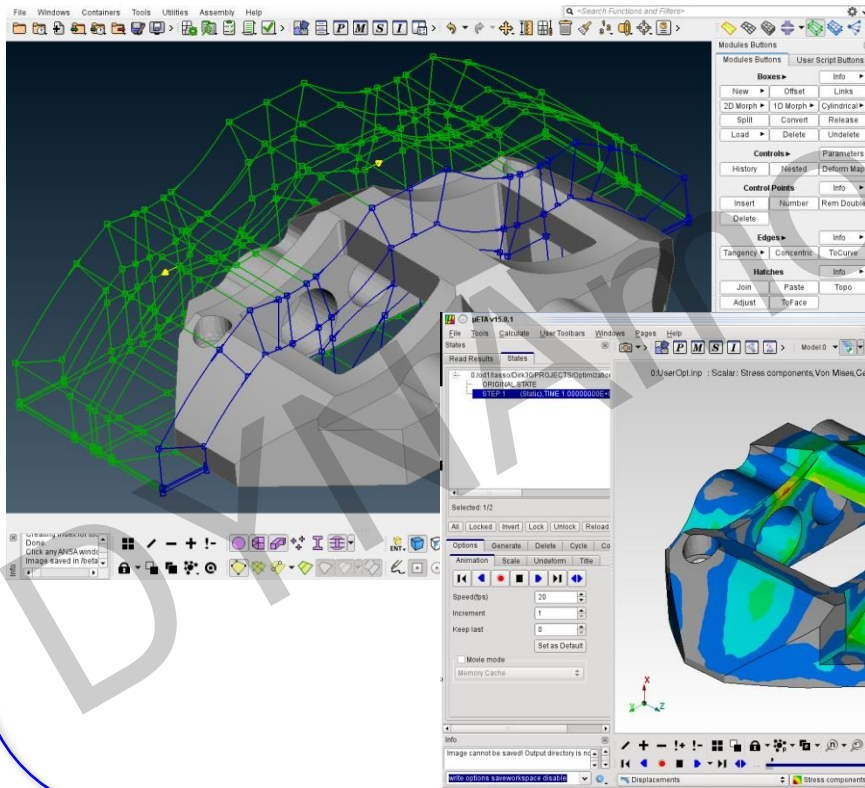

Ευχαριστώ πολύ

More information and examples on
www.lsoptsupport.com

Mail: ansa@lasso.de

