

Overview of Standards and Potential for New Regulation

Jim Rasico, Michiel van Ratingen, Mike Kulwicki

First Technology Safety Systems, Inc.

Contents

- US Regulatory Standard
- Industry Update
- Ejection Mitigation

Vehicle Crash Testing

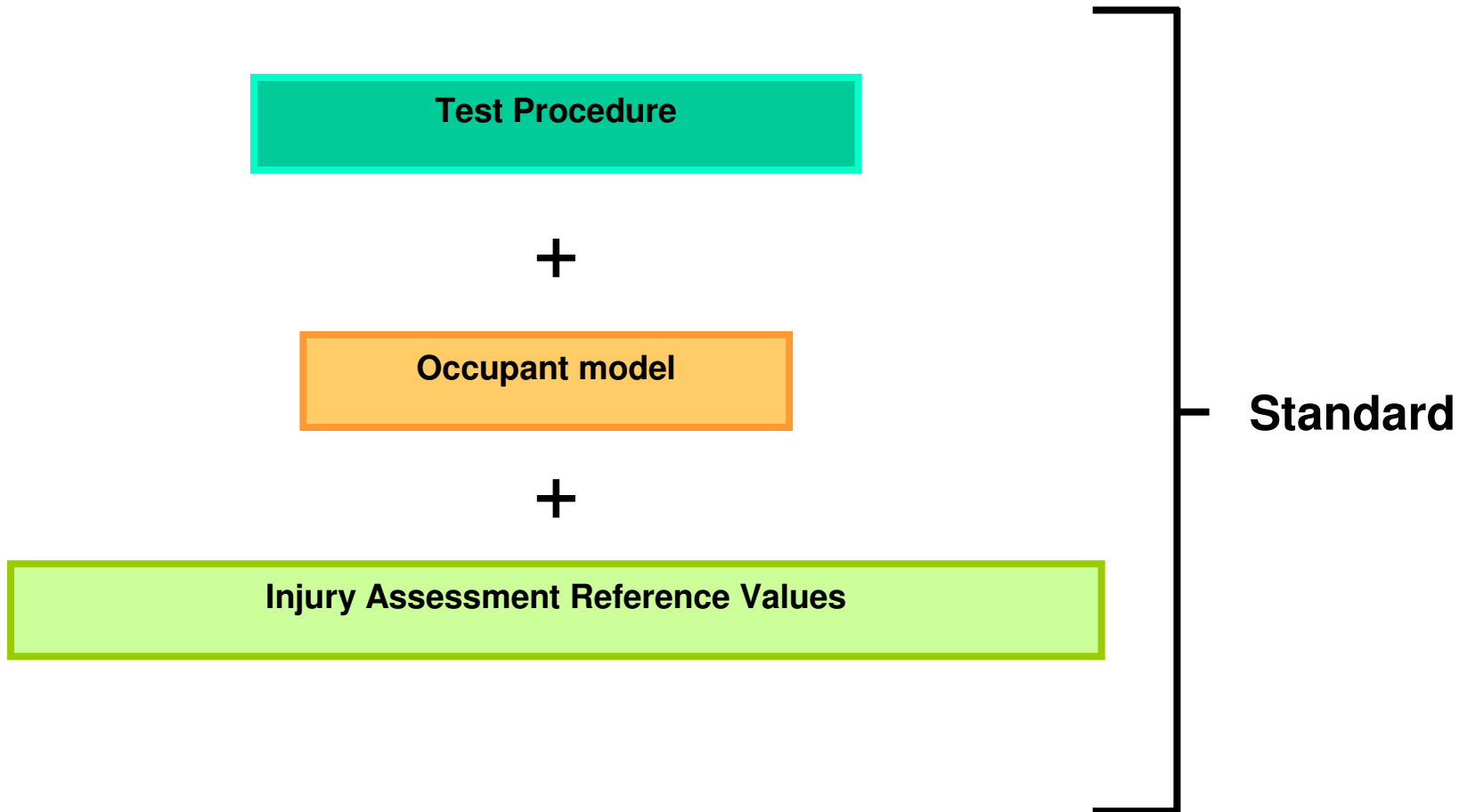

Test Procedure

- Test Conditions
 - Impact test angle
 - Specification of loading structure (barrier)
 - Temperature/humidity
- Test speed
- Preparation of the vehicle
- Dummy position
- Data acquisition & filtering

FMVSS 201 / EuroNCAP Pole Test

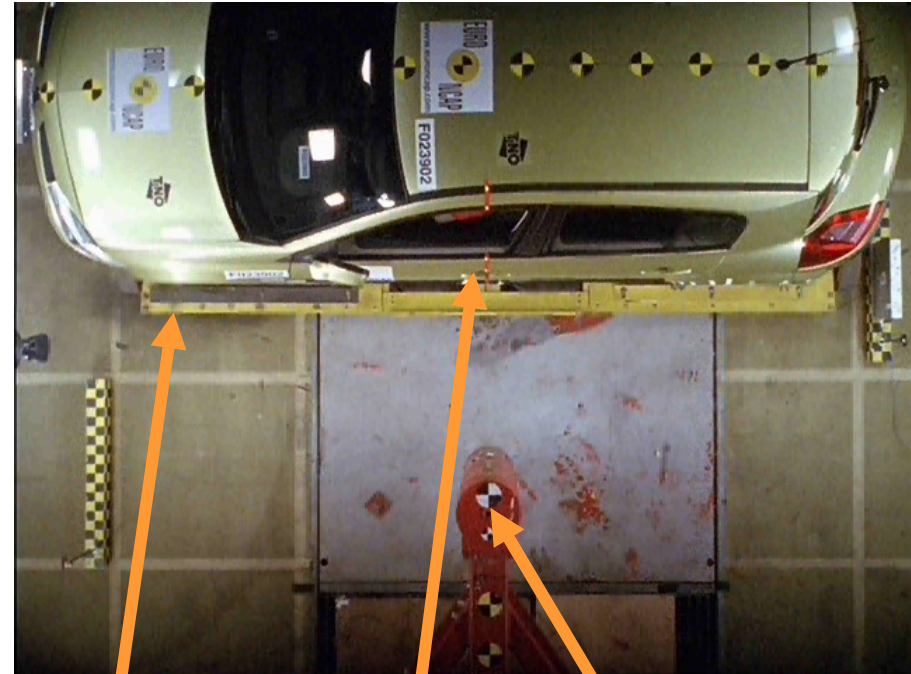

Impact speed/angle

Pole diameter

Impact location

Overview of Important Procedures

- Frontal full width and offset deformable barrier
- Side impact with mobile deformable barrier
- Lateral/oblique pole test
- Out of position airbag test
- Interior headform testing
- Pedestrian impact test
- Child restraint system testing

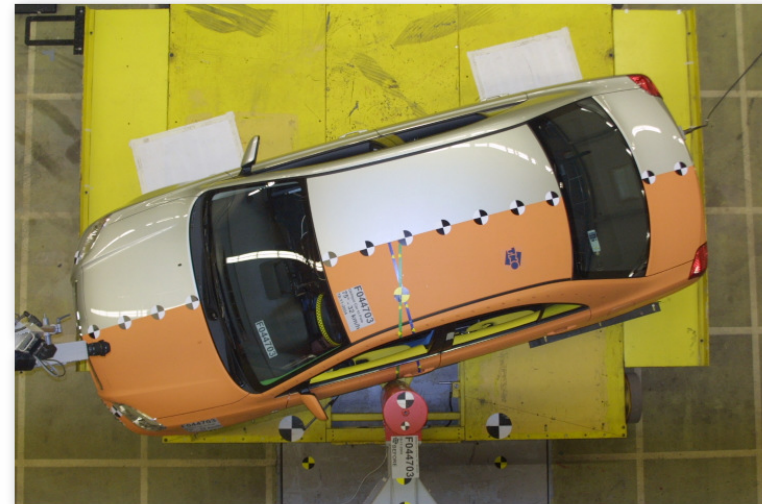

Vehicle Crash Testing

Test Procedure

+

Occupant model

Occupant Models

- Volunteers
- Human cadavers (PMHS)
- Living and dead animals
- Mechanical models (crash dummies)
- Mathematical models

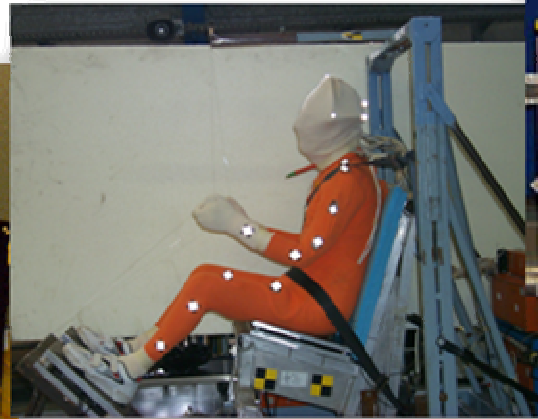
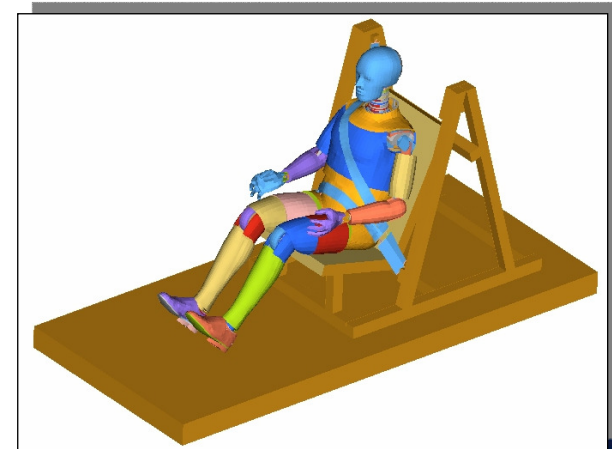

Crash Test Dummies: Hybrid-III

- Alderson Research and Sierra Engineering with GM Hybrid I, in 1971
- GM improves Hybrid I, developing the Hybrid II dummy
- Hybrid II dummy standard for frontal crash testing to comply with regulations governing restraint systems in 1972
- 1973-1977 the Hybrid III dummy is created
- In 1986 Hybrid III FMVSS 208 / NCAP
- In 1998, ECE R94 using H-III comes into effect

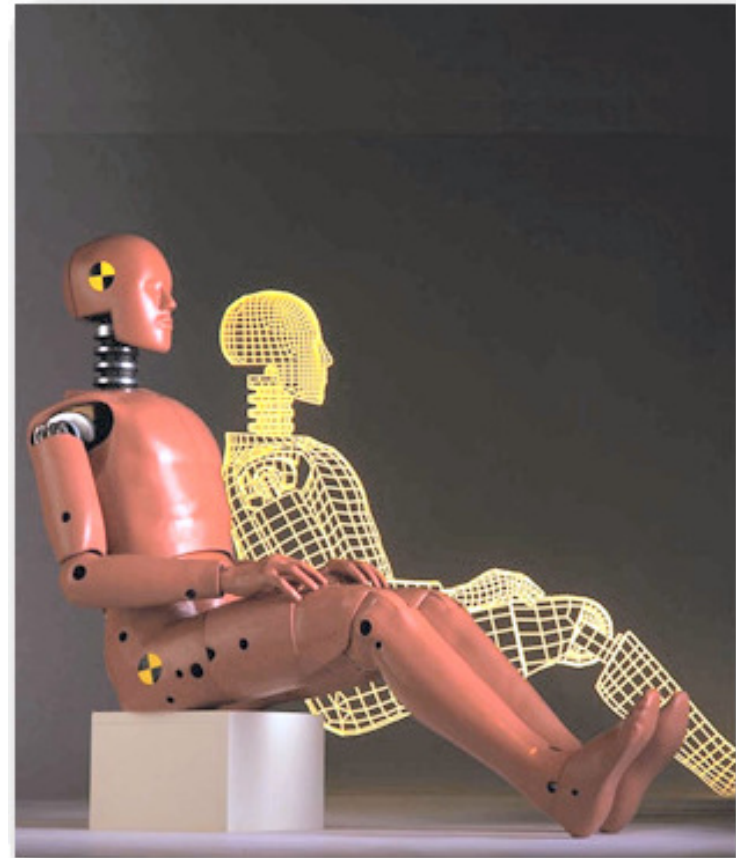

Crash Dummy Requirements

- Simplicity
- Anthropometry
- Biofidelity
- Repeatability
- Reproducibility
- Sensitivity
- Durability
- Handling
- Costs



Anthropometry

- Dimensions of body segments
- Location of joints & anatomical landmarks
 - Occipital condyles, T1, etc.
- Inertia properties & R.O.M.
 - Mass, location of CG
 - Moments of inertia, principal axes
- Surface (3D) information

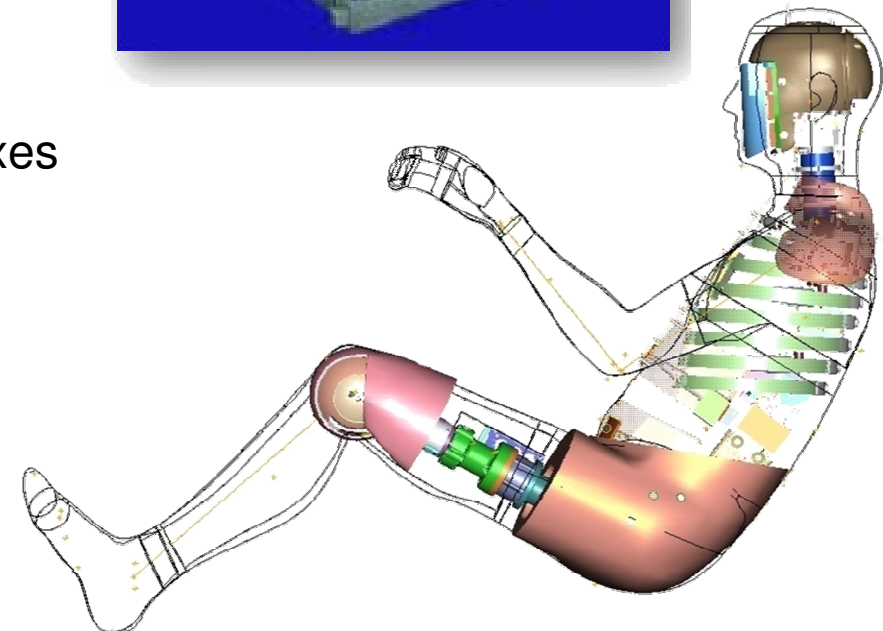

(c) 2003 FTSS

Biofidelity

- Response requirements
 - Volunteer/cadaver/animal subjects
 - Representative loading
 - Multiple tests
 - Sub-injury level (< AIS 2)

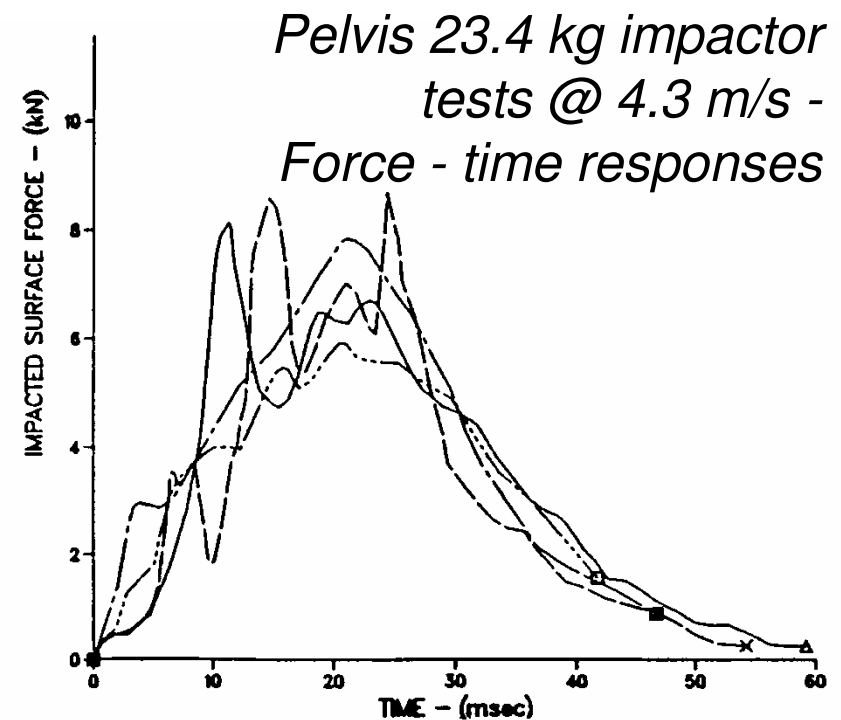
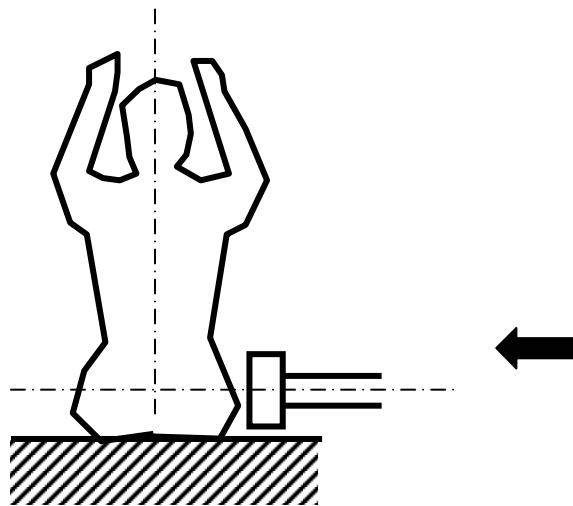

Biofidelity

- Normalisation of results
 - Response corridor as dummy design specification

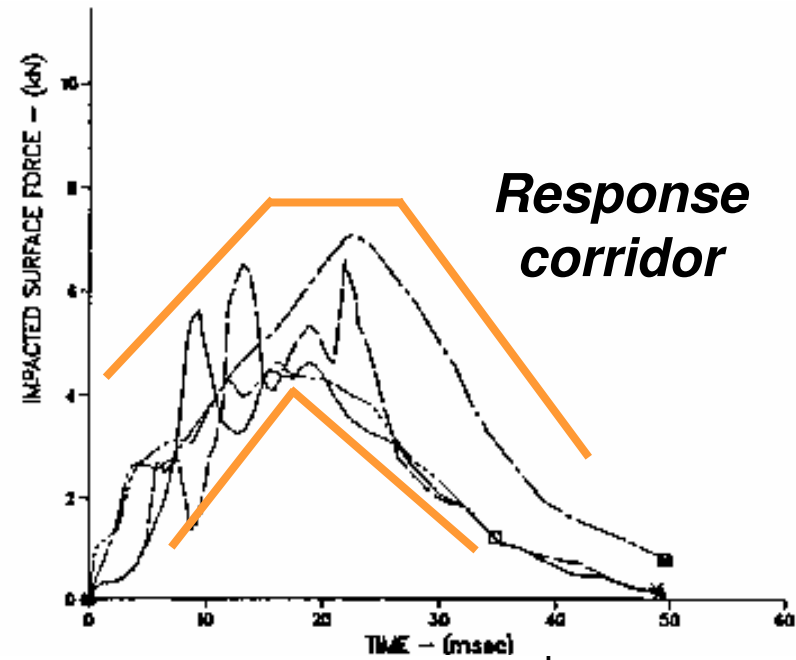
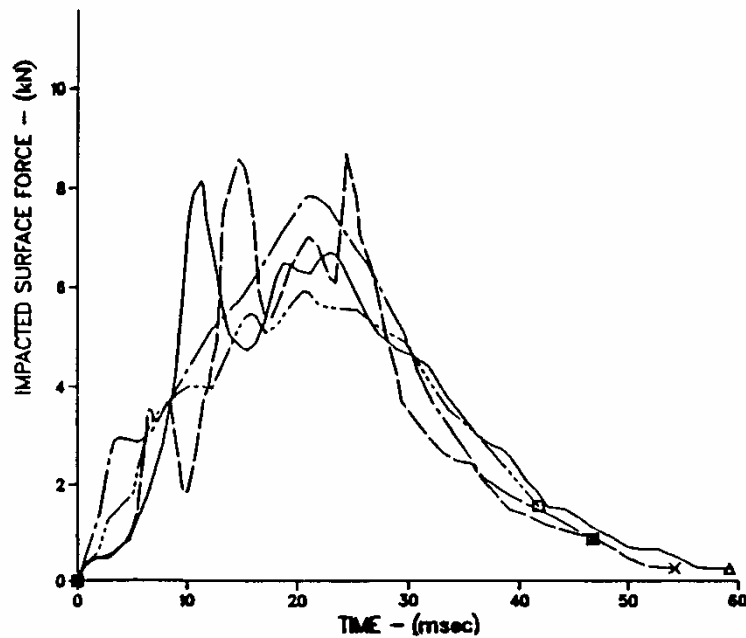

Biofidelity

- Dummy design and assessment
 - Select design and materials to reproduce human behaviour
 - Test dummy components in human test condition



'WorldSID' pelvis prototype in 23.4 kg mass impactor test

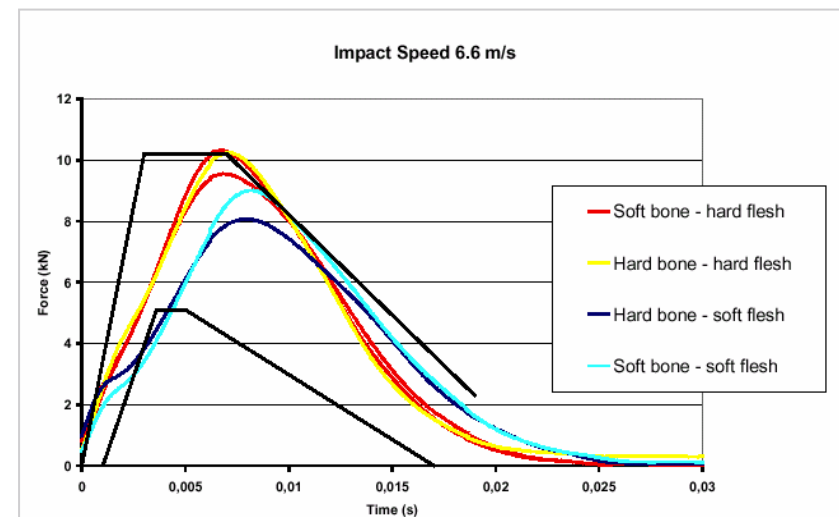
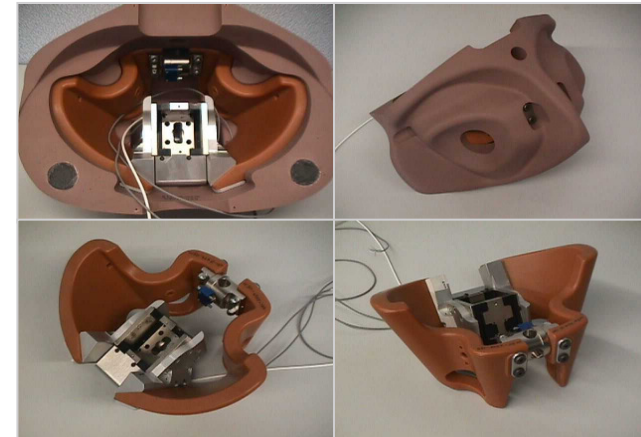

Repeatability

- Repeated tests on the same dummy gives same results
- Coefficient of variation: $CV = SD/\text{mean}$
 - $SD = 5\% \rightarrow \text{good}$
 - $SD = 10\% \rightarrow \text{acceptable}$

$$CV = \sum_{t=1}^I [a_1(t) - a_2(t)]^2$$

Reproducibility

- Same tests on dummies of identical design give same results
 - Important requirement for regulatory test devices
- Dummy certification
 - Prescribed response to standard stimulus
 - Set-up often based on biofidelity test
 - Certification corridors based on variability in first batch of production dummies (\neq biomechanical corridors)
 - Generally required after 10 tests or exceeding biomechanical limits

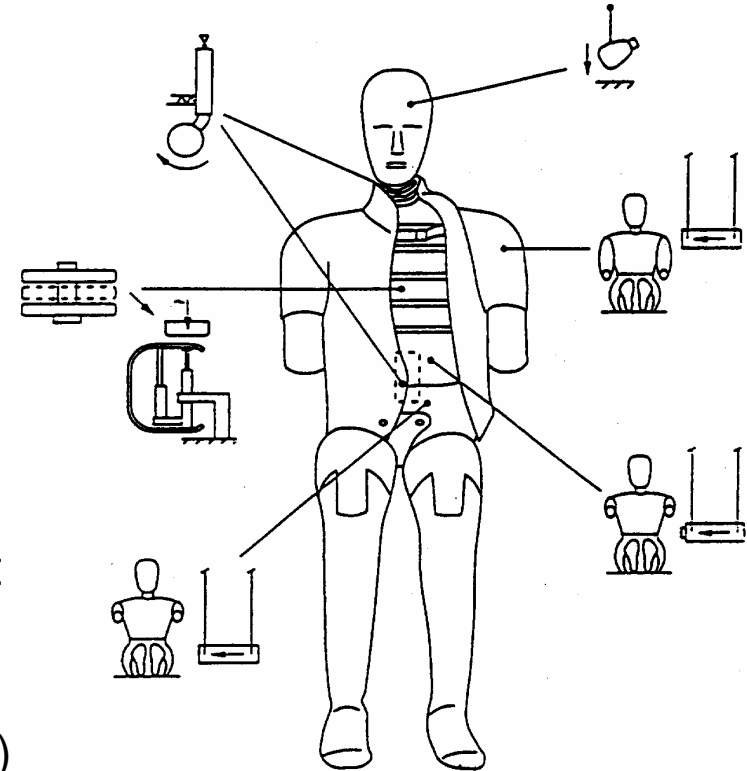

Certification tests for the EUROSID-2 side impact dummy

Vehicle Crash Testing

Test Procedure

+

Occupant model

+

Injury Assessment Reference Values

Injury Criteria

- Human mechanical resistance
 - Varies with age, body-weight, state of health
 - Variations apply for every body part
- Injury criteria
 - Physical (measurable) parameters
 - Correlate with injury

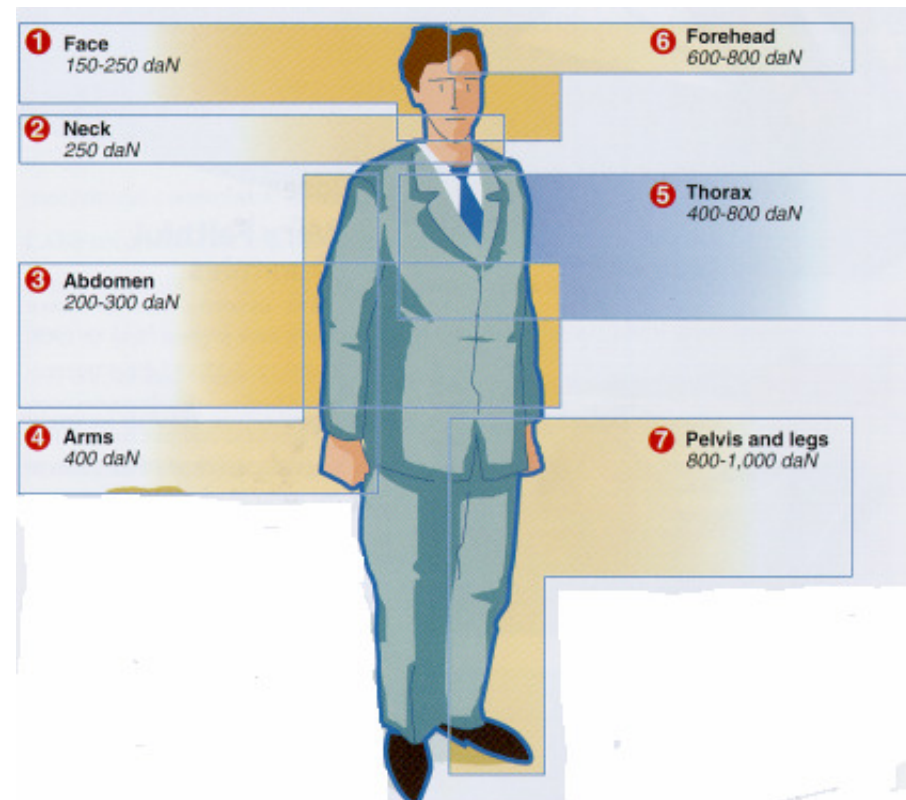

*Resistance to
pressure for 30-year-
old*

Injury Assessment Reference Values

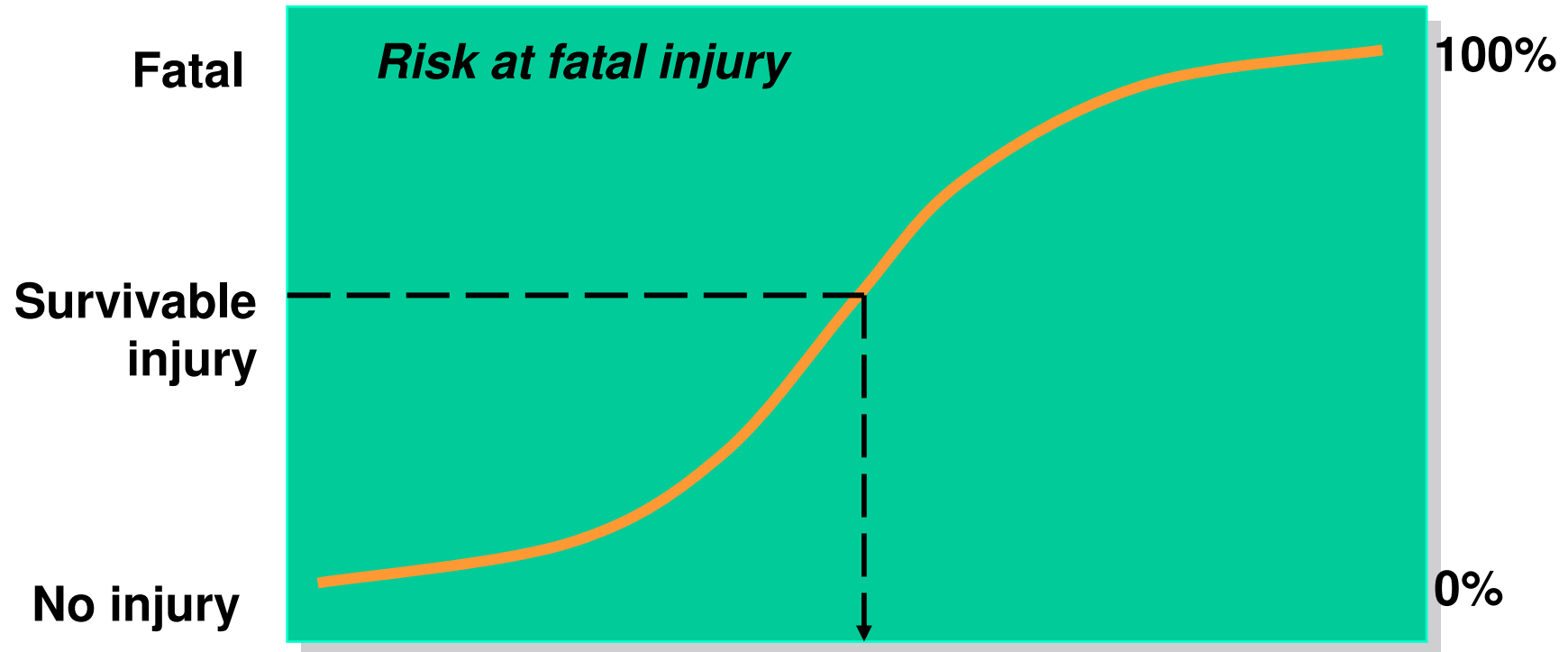

**Injury criterion = measured parameter
for instance chest compression**

Injury Limits

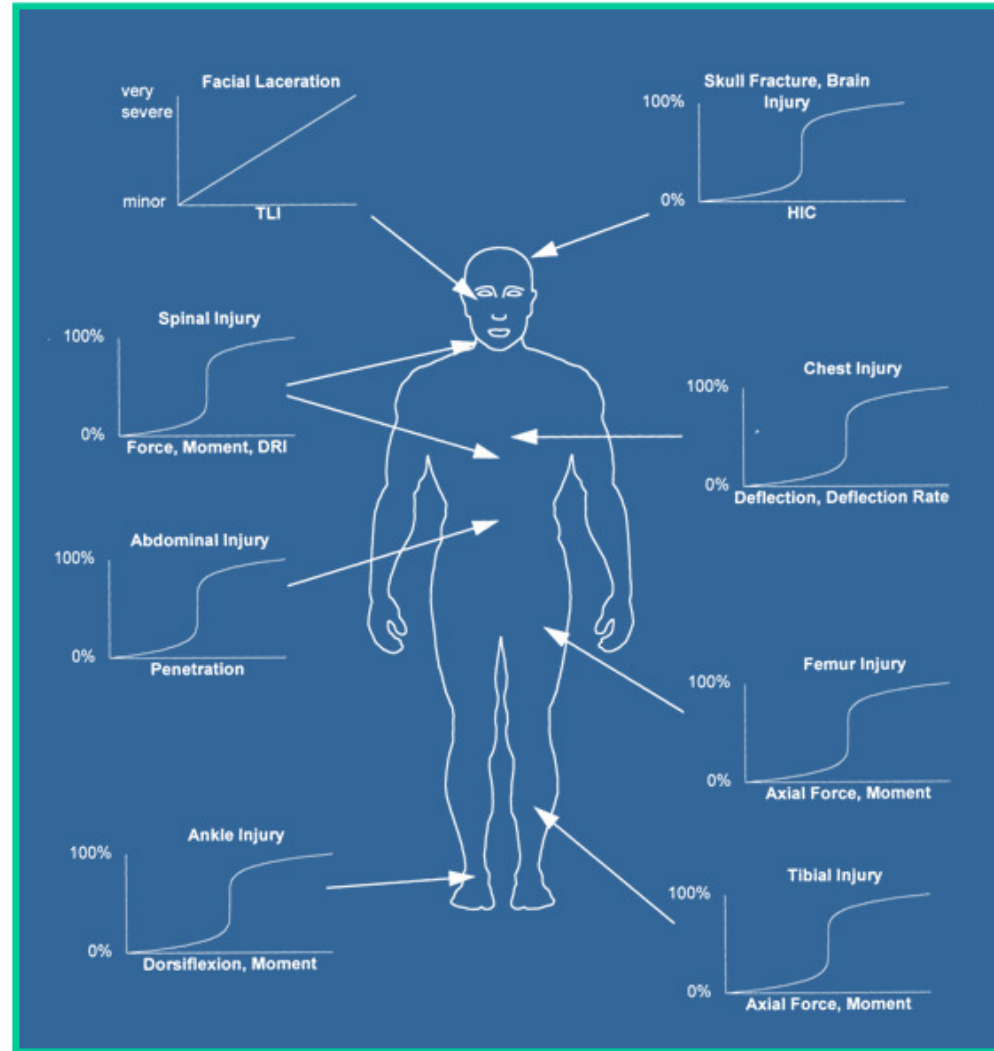

Update Dummy Models, DYNAmore GmbH Stuttgart, Copyright FTSS 2007, June 28 '07

Injury Criteria

- Instrumentation
 - Measurement of criteria and more
 - Performance criterion range + 50% overload
 - Resistance to high accelerations
 - ISO standards for filter class

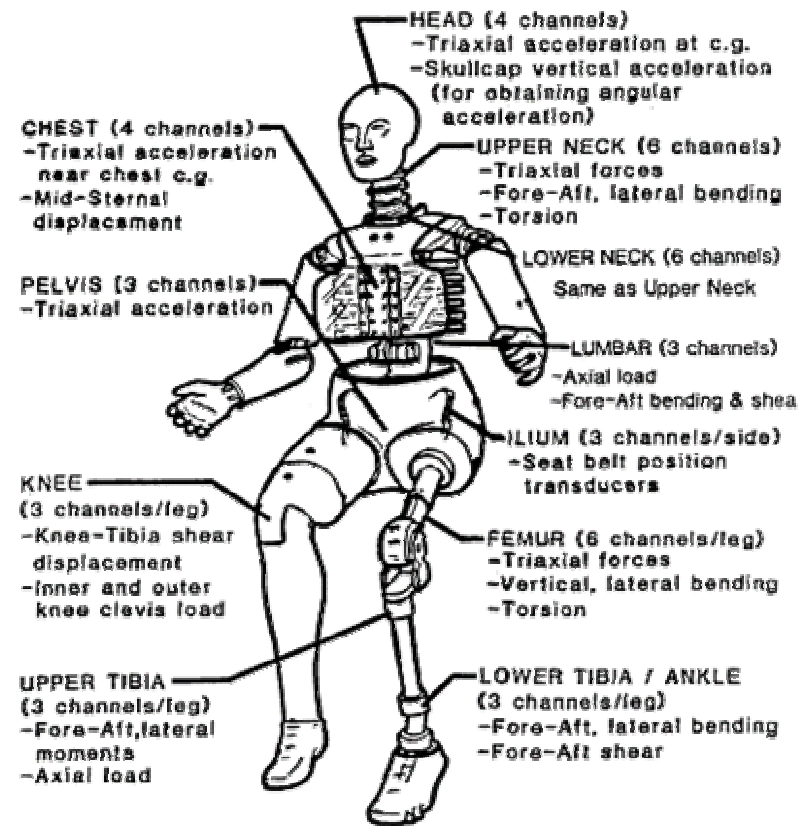
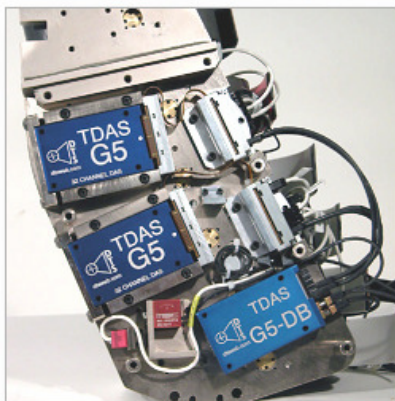

Sensors of 50th percentile male Hybrid-III dummy

Industry Update

Trends in regulation

- Protection in various crash modes
 - Full width frontal, frontal offset, side, rear, pedestrian, compatibility, roll-over
- International harmonisation of standards
- Increasing influence of consumer and insurance tests
 - EuroNCAP, US-NCAP, IIHS
- Virtual testing & regulations

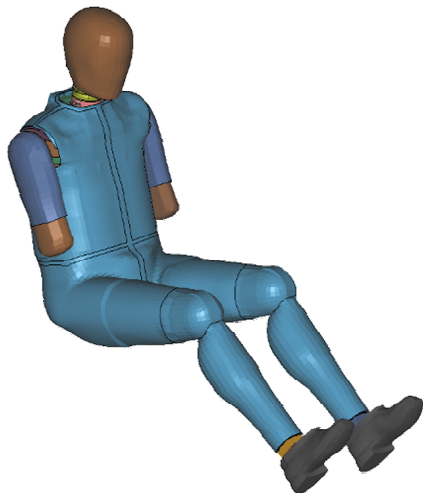
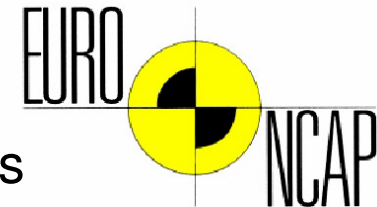

ATD Rulemaking Process - US

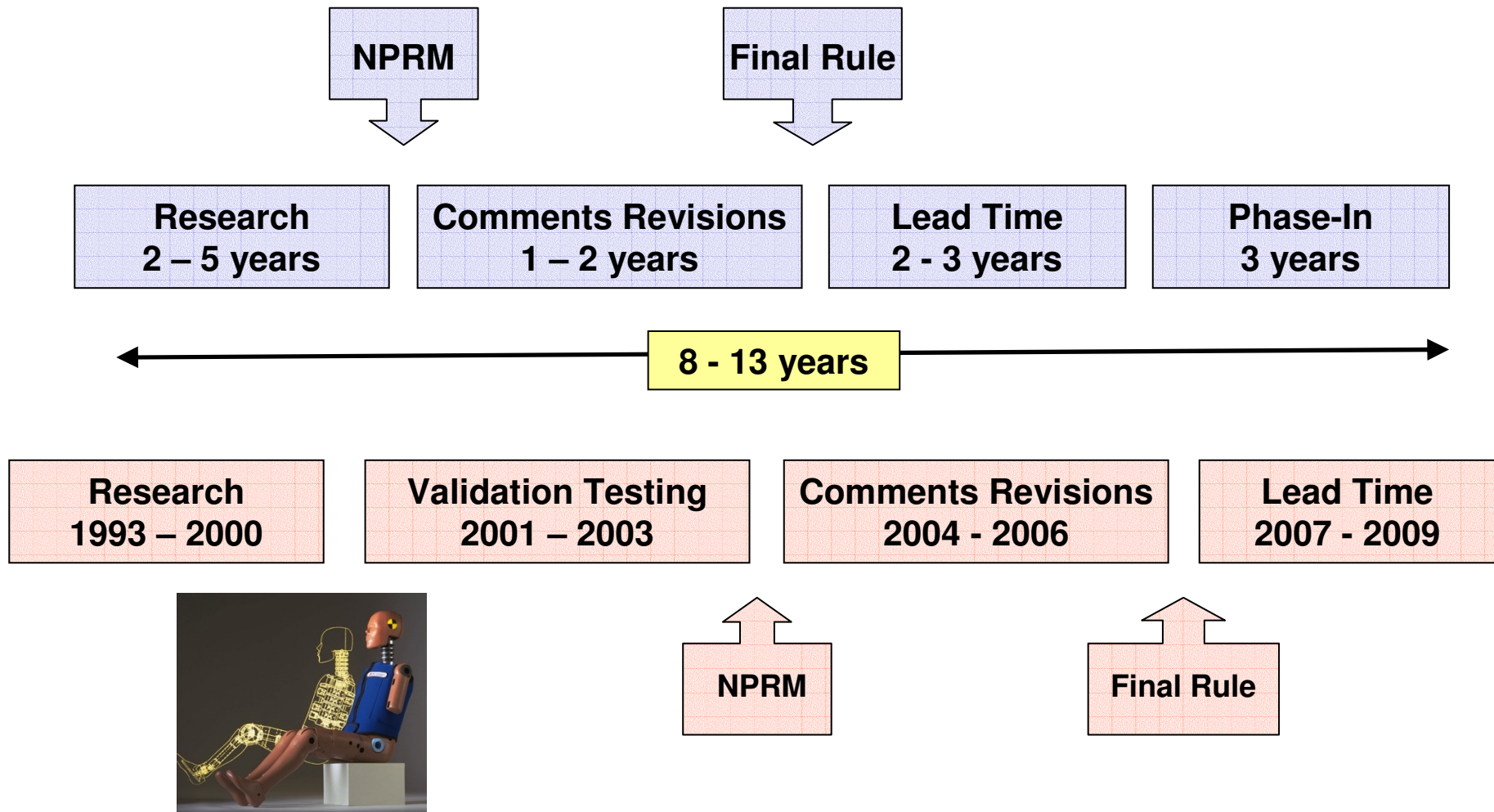

SID-IIs

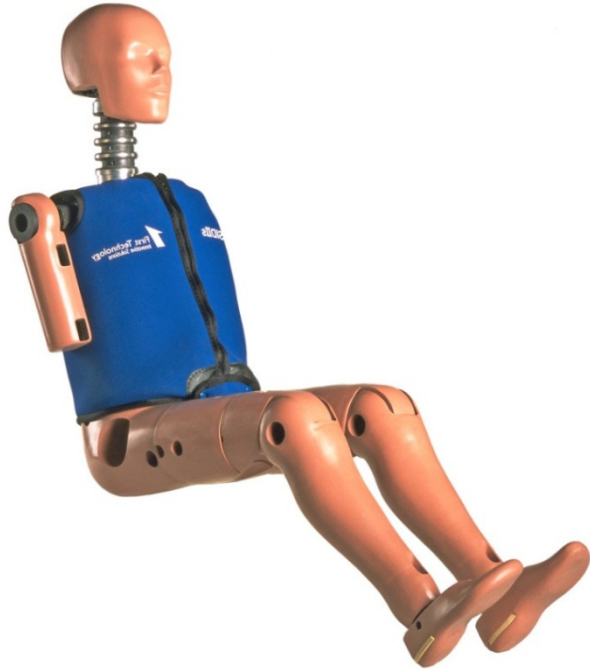

Service Bulletin

- In May 2004 NHTSA - NPRM upgrade FMVSS 214
- 49CFR, Part 572 Subpart “V”
- December 2004 NHTSA - NPRM for SID-IIs FRG
- FTSS with OSRP and SAE comment and recommend corridors by March 2005 deadline
- Industry suggested SBL D to NHTSA – now OSRP SBL D SID-IIs dummy
- December 2006 NHTSA Final Rule - SID-IIs SBL D
- Petition for OSRP D iliac wing...

SID-IIs

Service Bulletin

- For Final Rule component test conducted
- Using table below:

CV < 5%	=	Excellent
CV 5-8%	=	Good
CV 8-10%	=	Acceptable
CV > 10%	=	Unacceptable
- NHTSA rated SID-IIs repeatability and reproducibility as excellent to good

SID-IIs

Service Bulletin

- New test requirement Pelvis Iliac Impact Test
- Pendulum Impactor with rectangular face on WSID bench
- Calibration Corridors have been updated

Test Measure	SBL C	Final Rule	Petition
Max Shoulder Deflection (mm)	27 - 39	30 - 37	30 - 37
Peak Iliac Force (kN)	NA	3.7 - 4.5	3.6 – 4.4

SID-IIs

IIHS Iliac Wing Announcement

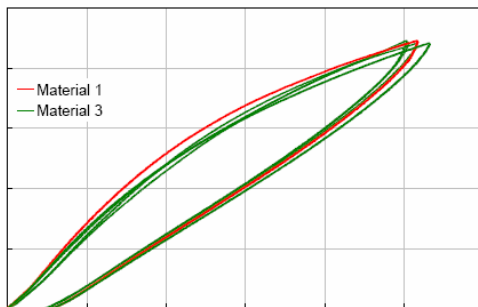
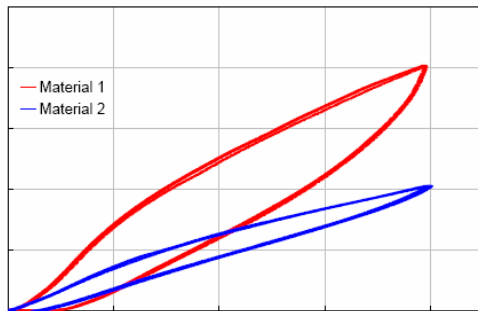

- In January of 2007 the IIHS announced that it will use the OSRP (FTSS) design for future testing.
- FTSS has worked with the OSRP SID-IIs Upgrade Task Group to address creep load problem. Material #3 with Standoffs.
- NHTSA was petitioned to change the specification to the FTSS-OSRP iliac wing design.

Ejection Mitigation Hardware

Ejection Mitigation Hardware

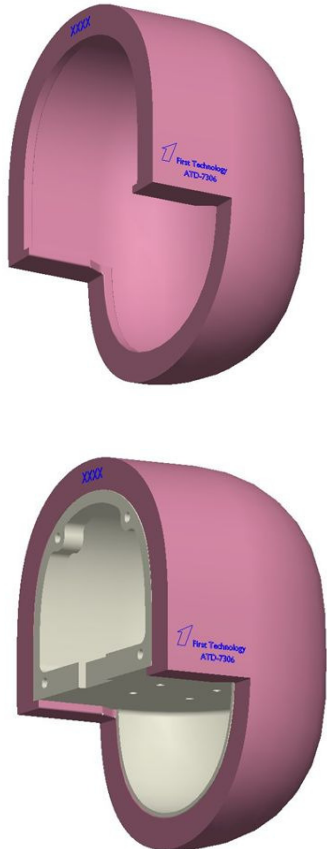

Hardware Statistics

- Roughly 200mm x 150 mm - aluminum
- Head skin 11 mm thick vinyl
- 18 Kgs (Impactor body and head form)
- Guided Impactor –
 - 200mm of travel
 - Displacement recorded
- 3 speeds and 2 delay times
 - 16 km/h with 6 sec delay
 - 20 km/h with 1.5 sec delay
 - 24 km/h with 1.5 sec delay

Ejection Mitigation Hardware

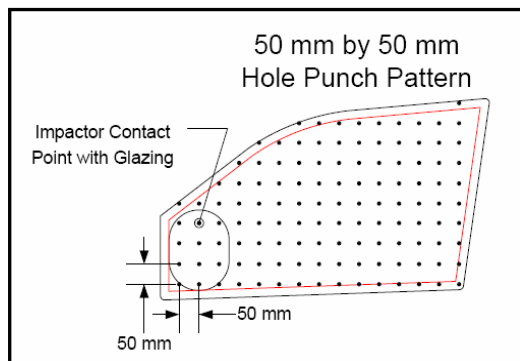
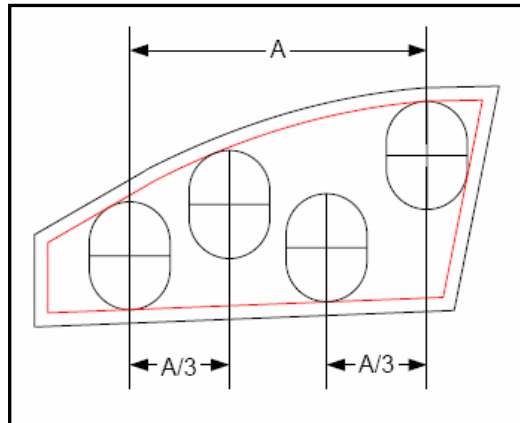

Procedure

- Locate test zones
- Raised vehicle
- Remove unnecessary interior items
- Determine excursion surface/plane
- Delay times for deployment of EMD – inflatable system
- Treatment of laminated glass
- Approach angle

Ejection Mitigation Hardware

May 25, 2007 Update

- Headform Assembly Weight: 3.2 kg – 3.5 kg
 - Includes
 - 1 Skull
 - 1 Skin
 - 1 Accelerometer mount
 - 3 Accelerometer
- Design to be finalized.
- Possible Dynamic calibration test in future.
- 1st Prototype Headform Assembly for evaluation complete in the end of May.
- Prototype release: July 2007

Thank You!