

Documentation

LS-DYNA

ES-2 50th - Version 5.0

ES-2re 50th - Version 5.0



User's Manual

Manual Release 1.0 for Model 5.0

April 1st, 2011

DYNAmore GmbH

www.dynamore.de

Germany

Authors:

Sebastian Stahlschmidt

Alexander Gromer

Reuben D'Souza

Contact Address:
Sebastian Stahlschmidt
DYNAmore GmbH
Industriestr. 2
70565 Stuttgart
Germany
Tel: +49-(0)711-459600-0
sebastian.stahlschmidt@dynamore.de

Copyright 2011 DYNAmore GmbH

Content

1.	GENERAL INFORMATION	- 5 -
1.1	KEYWORDS USED	- 7 -
2.	EXTRACTION OF OCCUPANT INJURY CRITERIA	- 9 -
2.1	RIB ACCELERATIONS	- 9 -
2.2	RIB INTRUSION	- 10 -
2.3	SPINE ACCELERATIONS	- 11 -
2.4	PELVIS ACCELERATION	- 12 -
2.5	HEAD ACCELERATION	- 12 -
2.6	PUBIC SYMPHYSIS FORCE	- 13 -
2.7	SHOULDER FORCE	- 14 -
2.8	BACK PLATE LOAD CELL.....	- 15 -
2.9	NECK LOAD CELLS.....	- 16 -
2.10	T12 LOAD CELL (LUMBAR SPINE)	- 17 -
2.11	LOWER LUMBAR LOAD CELL	- 18 -
2.12	ABDOMINAL FORCES	- 19 -
2.13	FEMUR LOAD CELLS	- 20 -
2.14	ES-2RE EXTENSION FORCES.....	- 21 -
3.	ACCELEROMETERS	- 22 -
4.	LOCAL COORDINATE SYSTEMS FEHLER! TEXTMARKE NICHT DEFINIERT.	
5.	LICENSE FILE	- 23 -
6.	INCORPORATING THE DUMMY IN VEHICLE MODELS	- 25 -
6.1	POSITIONING, TREE FILE	- 25 -
6.2	MEASURING OF PELVIS AND TORSO ANGLE	- 28 -
6.3	NUMBERING.....	- 29 -
6.4	CONTACT DEFINITION	- 29 -
6.5	ADDITIONAL REMARKS.....	- 30 -
7.	RELEASE NOTES FROM V4.5 TO V5.0	- 31 -
7.1	GEOMETRIC MODIFICATIONS	- 31 -
7.2	NON-GEOMETRIC DUMMY MODEL MODIFICATIONS	- 32 -
7.3	ADDITIONAL REMARKS.....	- 32 -
8.	LIMITATIONS AND FURTHER WORK	- 33 -
9.	PERFORMANCE	- 34 -
9.1	COMPONENT TESTS.....	- 34 -
9.1.1	Arm Test.....	- 34 -
9.1.2	Clavicle test.....	- 39 -
9.1.3	Clavicle Box test	- 46 -
9.1.4	Abdomen slab test	- 62 -
9.1.5	Abdomen test	- 65 -
9.1.6	Lumbar spine test	- 84 -
9.1.7	Iliac wing test.....	- 85 -
9.1.8	Femur stopper test.....	Fehler! Textmarke nicht definiert.
10.	PERFORMANCE	- 109 -
10.1	CONFIGURATION D1: PLANE BARRIER	- 109 -
10.1.1	Results at low velocity impact.....	- 110 -
10.2	CONFIGURATION D3: BARRIER WITH PELVIS BUMPER	- 114 -
10.2.1	Results at high velocity impact.....	- 115 -
10.3	CONFIGURATION D4: DOOR BARRIER.....	- 119 -

10.3.1	Results at high velocity impact.....	- 120 -
10.4	SHOULDER CERTIFICATION TEST OF ES-2	- 124 -
10.4.1	Results	- 125 -
10.5	ABDOMEN CERTIFICATION TEST OF ES-2	- 126 -
10.5.1	Results	- 127 -
10.6	PELVIS CERTIFICATION TEST OF ES-2	- 128 -
10.6.1	Results	- 129 -
10.7	RIB MODULE TESTS	- 94 -
10.7.1	Test setup 1	- 94 -
10.7.2	Test setup 1: velocity 1	- 94 -
10.7.3	Test setup 1: velocity 2	- 95 -
10.7.4	Test setup 1: velocity 3	- 95 -
10.7.5	Test setup 1: velocity 4	- 96 -
10.7.6	Test setup 1: velocity 5	- 96 -
10.7.7	Test setup 2	- 97 -
10.7.8	Test setup 2: velocity 1 low mass	- 97 -
10.7.9	Test setup 2: velocity 1 high mass	- 98 -
10.7.10	Test setup 2: velocity 2 low mass	- 98 -
10.7.11	Test setup 2: velocity 2 high mass	- 99 -
10.7.12	Test setup 2: velocity 3 low mass	- 99 -
10.7.13	Test setup 2: velocity 3 high mass	- 100 -
10.7.14	Test setup 2: velocity 4 low mass	- 100 -
10.7.15	Test setup 2: velocity 4 high mass	- 101 -
10.7.16	Test setup 2: velocity 5 low mass	- 101 -
10.7.17	Test setup 2: velocity 5 high mass	- 102 -
10.7.18	Test setup 3	- 102 -
10.7.19	Test setup 3: velocity 1	- 103 -
10.7.20	Test setup 3: velocity 2	- 103 -
10.7.21	Test setup 3: velocity 3	- 104 -
10.7.22	Test setup 3: velocity 4	- 104 -
10.7.23	Test setup 3: velocity 5	- 105 -
10.7.24	Test setup 4	- 105 -
10.7.25	Test setup 4: velocity 1	- 106 -
10.7.26	Test setup 4: velocity 2	- 106 -
10.7.27	Test setup 4: velocity 3	- 107 -
10.7.28	Test setup 4: velocity 4	- 107 -
10.7.29	Test setup 4: velocity 5	- 108 -
10.8	PERFORMANCE UNDER SMP & MPP	- 130 -
10.8.1	Results at low speed	- 131 -
10.8.2	Results at high speed	- 133 -
10.9	ADDITIONAL TEST OF ES-2RE – PENDULUM AT 90 DEGREE WITHOUT JACKET AND ARM	- 135 -
10.9.1	Results at low velocity	- 136 -
10.9.2	Results at high velocity	- 137 -
10.10	ADDITIONAL TEST OF ES-2RE – PENDULUM AT 45 DEGREE WITHOUT JACKET AND ARM ..	- 138 -
10.10.1	Results at low velocity	- 139 -
10.10.2	Results at high velocity	- 140 -
10.11	ADDITIONAL TEST OF ES-2RE – PENDULUM AT 45 DEGREE WITHOUT JACKET AND ARM ..	- 141 -
10.11.1	Results	- 142 -

1. General information

The development and validation has been performed on different platforms. The following LS-DYNA versions have been used:

LS-DYNA Version	Revision Nr.	Product-ID.
971 R4.2.1 SMP	53450	53450
971 R5.1 SMP	64531	64536
971 R4.2.1 MPP	53450	64994
971 R5.1 MPP	64531	64638

Table 1: LS-DYNA versions.

With the version 5.0 of the Euro-SID 2 50th model the following keyword files are delivered:

File name	Content
es2_v5.0_mm_ms_kg.key	Dummy model, the file name might vary depending on the system of units
es2_v5.0_nullshells.key	Optional contact shells
es2_v5.0_mm_ms_kg_load_curves_work.key	Dummy curves for working on the model with a pre-processor
es2_vendor_a.date_license_comp_e.date.asc	License file including the table and curves of the model
Positioning_es2_v5.0_mm_ms_kg.key	File for positioning the dummy by a pre-simulation
start_es2_v5.0_mm_ms_kg.key	Contains all include definitions a simple run

Table 2: Files delivered.

The numbering scheme of the original model is shown in Table 3. The IDs below refer to the ES-2re model including the optional nulls shells. On demand we deliver renumbered input decks, according to user specifications.

Component	Min ID	Max ID	Total number
Nodes	10000	274131	241971
Solids	13000	447722	194704
Beams	10000	12616	486
Shells	220001	466106	145747
Discrete elements	10500	10517	16
Mass elements	10502	15010	9
Accelerometer	1001	1019	9
Set nodes	1005	1008	4
Set parts	1001	1540	28
Parts	1	740	495
Materials	1001	1199	178
Sections	1001	1190	186
Hourglass	1001	1006	6
Joints	1001	1013	14

Joint stiffness	1001	1016	15
Contacts	1001	1013	12
Local coordinate systems	1001	1043	42
Load curves / tables	1001	1199	167
Time history nodes	10001	10021	9
Time history elements	10000	10016	17

Table 3: Model numbering scheme.

2. Keywords Used

The following control and database keywords are used:

*CONTROL_ACCURACY	*CONTROL_OUTPUT
*CONTROL_BULK_VISCOSITY	*CONTROL_SHELL
*CONTROL_CONTACT	*CONTROL_TERMINATION
*CONTROL_CPU	*CONTROL_TIMESTEP
*CONTROL_ENERGY	*CONTROL_SOLUTION

Table 4: Used Control cards.

The following database cards are defined:

*DATABASE_ABSTAT	*DATABASE_HISTORY_NODE_ID
*DATABASE_BINARY_D3PLOT	*DATABASE_JNTFORC
*DATABASE_MATSUM	*DATABASE_SLEOUT
*DATABASE_DEFORC	*DATABASE_NODOUT
*DATABASE_ELOUT	*DATABASE_RCFORC
*DATABASE_EXTENT_BINARY	
*DATABASE_GLSTAT	
*DATABASE_HISTORY_BEAM_ID	

Table 5: Used Database cards.

The following material models are used:

*MAT_DAMPER_NONLINEAR_VISCOUS	*MAT_SPRING_ELASTIC
*MAT_ELASTIC	*MAT_VISCOELASTIC
*MAT_FU_CHANG_FOAM	*MAT_SPOTWELD
*MAT_LINEAR_ELASTIC_DISCRETE_BEAM	*MAT_NONLINEAR_ELASTIC_DISCRETE_BEAM
*MAT_NULL	
*MAT_PLASTIC_KINEMATIC	
*MAT_RIGID	
*MAT_SIMPLIFIED_RUBBER	
*MAT_SPRING_NONLINEAR_ELASTIC	
*MAT_SIMPLIFIED_RUBBER_WITH_DAMAGE	

Table 6: Used Material models.

The following other keywords are used:

*CONSTRAINED_EXTRA_NODES_SET	*ELEMENT_SEATBELT_ACCELEROMETER
*CONSTRAINED_JOINT_CYLINDRICAL_ID	*ELEMENT_SHELL
*CONSTRAINED_JOINT_SPHERICAL_ID	*ELEMENT_SOLID
*CONSTRAINED_JOINT_STIFFNESS_GENERALIZED	*ELEMENT_MASS
*CONSTRAINED_JOINT_TRANSLATIONAL	*NODE
*CONSTRAINED_RIGID_BODIES	*SECTION_BEAM

*CONTACT_AUTOMATIC_SINGLE_SURFACE	*SECTION_DISCRETE
*CONTACT_FORCE_TRANSDUCER_PENALTY	*SECTION_SHELL
*CONTACT_TIED_SHELL_EDGE_TO_SURFACE_ID_OFFSET	*SECTION_SOLID
*DAMPING_PART_STIFFNESS	*SET_PART_LIST
*DEFINE_COORDINATE_NODES	*SET_SHELL_LIST
*DEFINE_CURVE	*HOURGLASS
*DEFINE_TABLE	*INITIAL_FOAM_REFERENCE_GEOMETRY
*ELEMENT_BEAM_(ORIENTATION)	*PARAMETER
*ELEMENT_DISCRETE	*PART_CONTACT

Table 7: Other keywords used in the model.

After the *END keyword the following Primer keywords are defined:

*ASSEMBLY	*DUMMY_END
*DUMMY_START	*H_POINT
*UNITS	*POINT_LOCATION

Table 8: Used Primer keywords.

3. Extraction of occupant injury criteria

To extract occupant injury criteria from the model, the following preparations have been made.

3.1 Rib accelerations

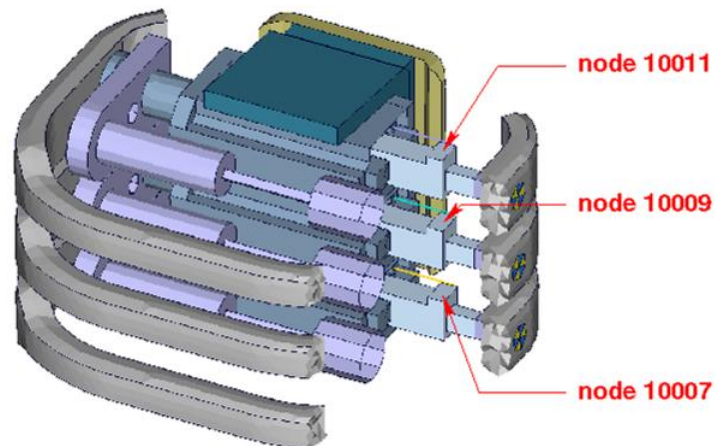

Figure 1: Nodes for extracting rib accelerations

The marked nodes, which are shown in Figure 1, are accelerometer nodes. The description of the accelerometer definitions for the local output is shown in next table.

Item	Node-ID	Label	Component
Upper Rib	10011	acceleration upper rib	Local y-acceleration
Middle Rib	10009	acceleration middle rib	Local y-acceleration
Lower Rib	10007	Acceleration lower rib	Local y-acceleration

Table 9: Rib acceleration nodes

3.2 Rib intrusion

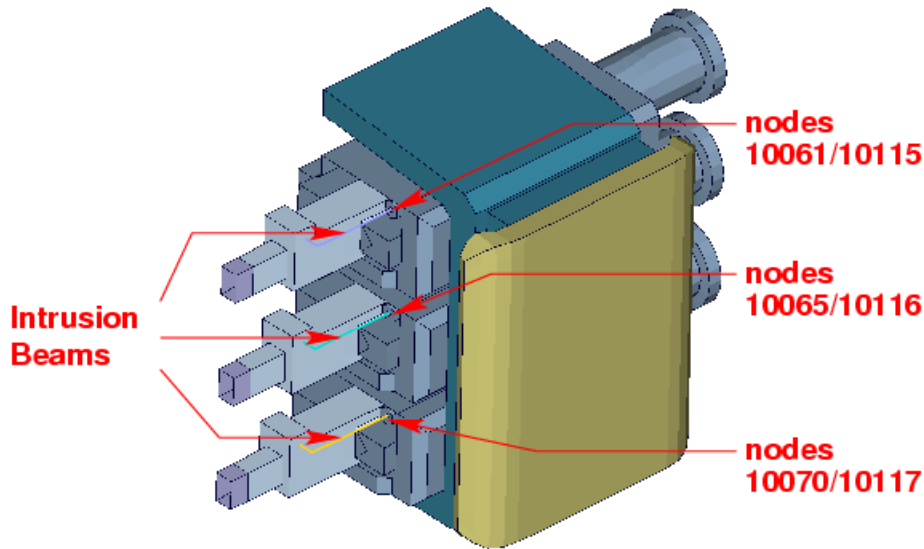

Figure 2: Nodes for extracting rib intrusions

The rib intrusions can be measured by determining distances of nodes. The nodes, shown in Figure 2 are coincident at the beginning of the simulation. An appearing distance of the nodes gives the rib intrusion of the model.

Item	Node-ID	Label	Component
Upper Rib intrusion	10061 10115	Intrusion upper rib 1 Intrusion upper rib 2	Relative displacement Relative displacement
Middle Rib intrusion	10065 10116	Intrusion middle rib 1 Intrusion middle rib 2	Relative displacement Relative displacement
Lower Rib Intrusion	10070 10117	Intrusion lower rib 1 Intrusion lower rib 2	Relative displacement Relative displacement

Table 10: Rib intrusion nodes

Alternatively, the elongation of a spring can be used to determine the rib intrusion. The spring elements are listed in the following table. The springs are located in the piston bearing system.

We do recommend to use spring elements to determine the elongation.

Item	Element-ID	Component
Upper Rib intrusion	10500	Change in length
Middle Rib intrusion	10501	Change in length
Lower Rib Intrusion	10502	Change in length

Table 11: Rib intrusion elements

3.3 Spine accelerations

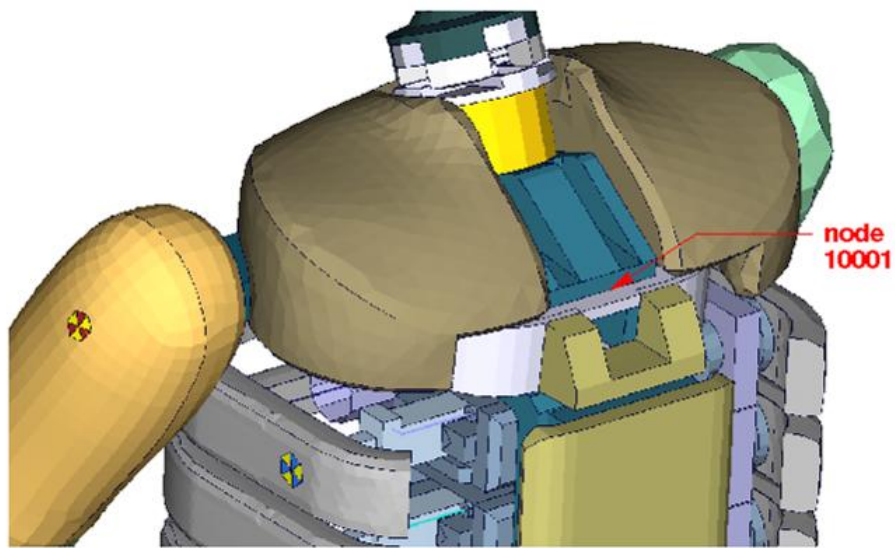

Figure 3: Node for extracting upper spine acceleration

Node 10001, which is marked in Figure 3 is part of the lower plate of neck bracket. An accelerometer is defined.

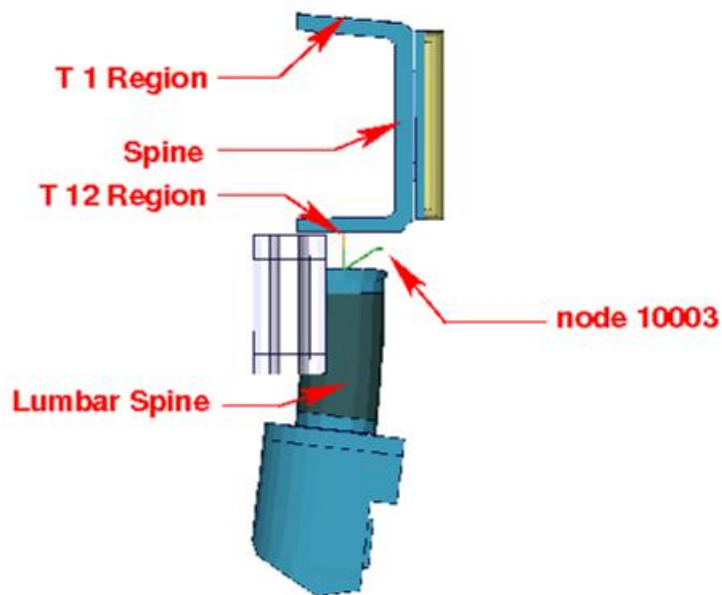

Figure 4: Node for extracting lower spine acceleration

Figure 4 shows parts of the dummy model from y direction. Node 10003 is located between upper spine and lumbar spine. An accelerometer is defined.

Item	Node-ID	Label	Component
Upper spine	10061	Acceleration upper spine	y-acceleration
Lower Spine	10003	Acceleration lower spine	y-acceleration

Table 12: Spine acceleration nodes

3.4 Pelvis acceleration

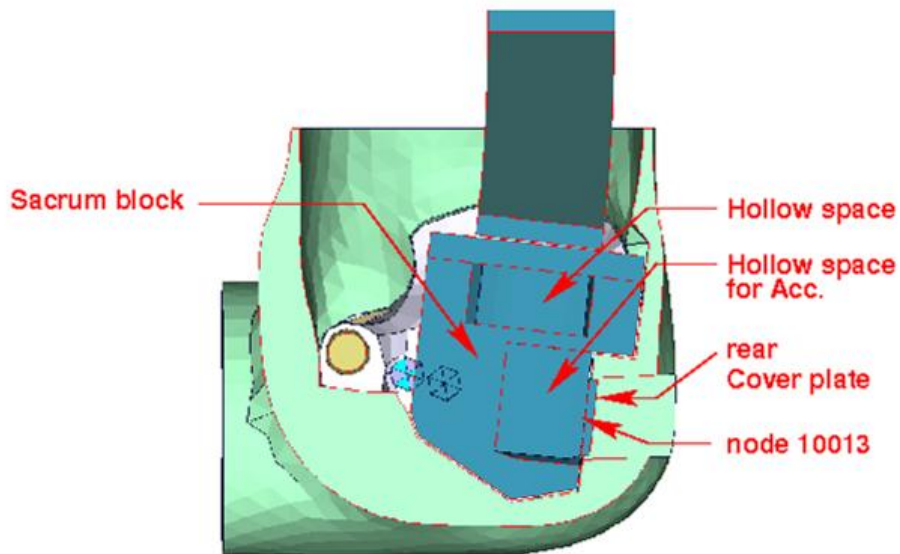

Figure 5: Node for extracting pelvis acceleration

Figure 5 shows a plane cut along the z-x-plane. The accelerometer is mounted in the marked hollow space. Node 10013 is located on the rear cover plate of sacrum block. An accelerometer is defined.

Item	Node-ID	Label	Available components
Pelvis	10013	accelerometer pelvis	Local y-acceleration

Table 13: Pelvis accelerometer node.

3.5 Head acceleration

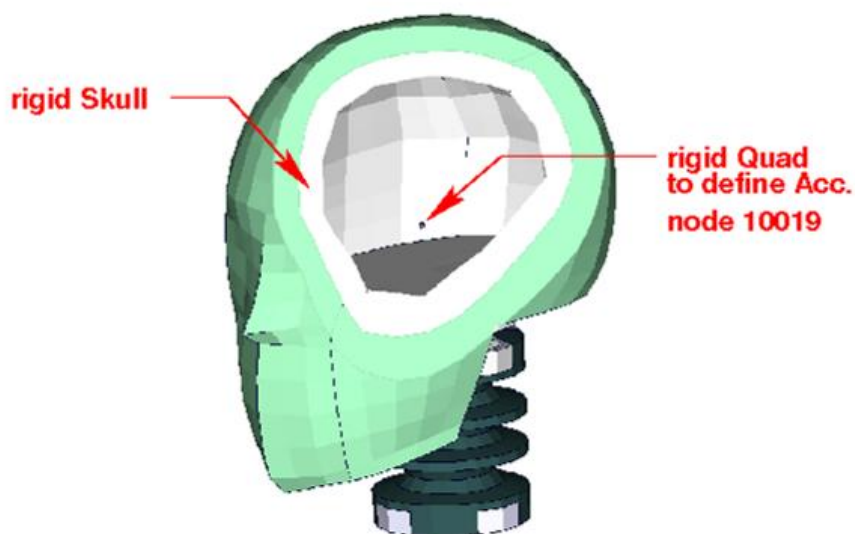

Figure 6: Node for extracting head acceleration

Figure 6 shows the head model; the aluminum skull is merged with the marked rigid quad. Node 10019 is located on the quad. An accelerometer is defined.

Item	Node-ID	Label	Available components
Head	10019	accelerometer head	local x-,y-,z- acceleration

Table 14: Head accelerometer node

3.6 Pubic Symphysis force

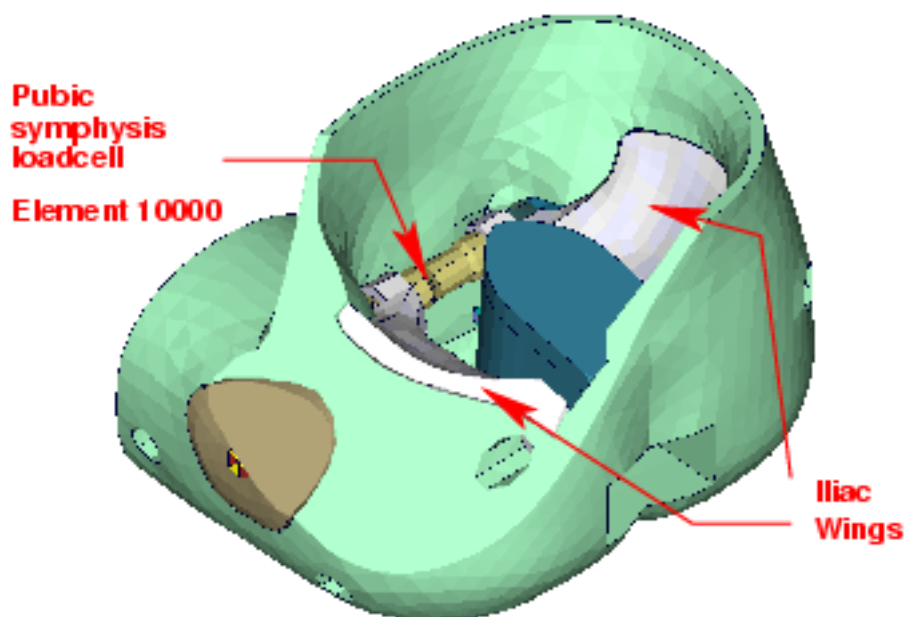

Figure 7: location for extracting signals of pubic symphysis load cell

Figure 7 shows the pubic symphysis load cell. The left iliac wing is connected to the first part of the load cell. The right iliac wing is connected to the second part. Both load cell parts generate under load the force in the connecting element 10000. The pubic symphysis force is the shear-S force of beam element 10000.

Item	Beam-ID	Label	Component
Pubic symphysis force	10000	Pubic symphysis load cell	Shear-S force

Table 15: Pubic force beam

3.7 Shoulder force

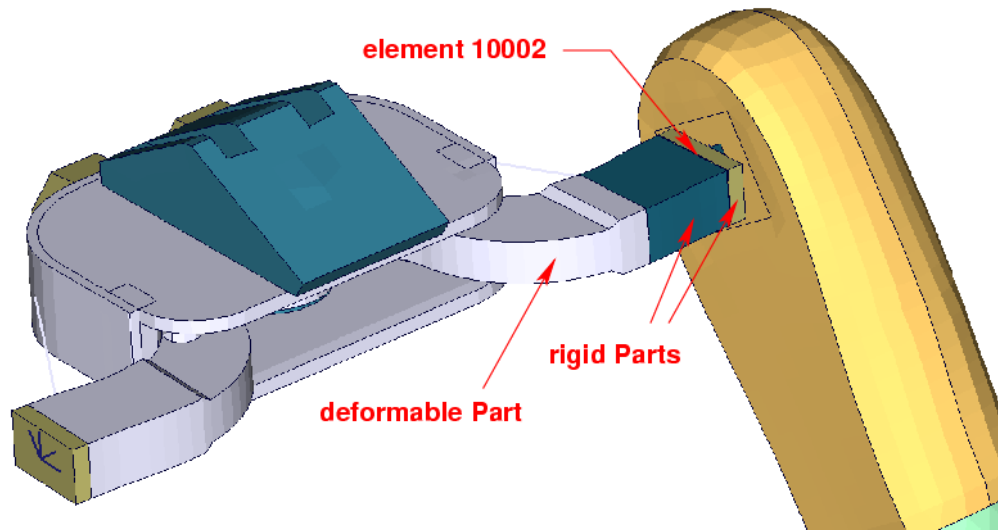

Figure 8: clavicle box with adapted clavicle to measure shoulder forces

Element 10002 which is marked in Figure 8 is a discrete beam with coincident nodes. The clavicle is equipped with load cell. The load cell is represented by a rigid box. The discrete beam is located between the rigid box and the arm adaptor plate. For local determination a local coordinate system is provided. The components are shown in table below.

Item	Beam-ID	Label	Component
Shoulder force x-direction y-direction	10002	Clavicle load cell	force axial shear-S

Table 16: Shoulder force beam

3.8 Back plate load cell

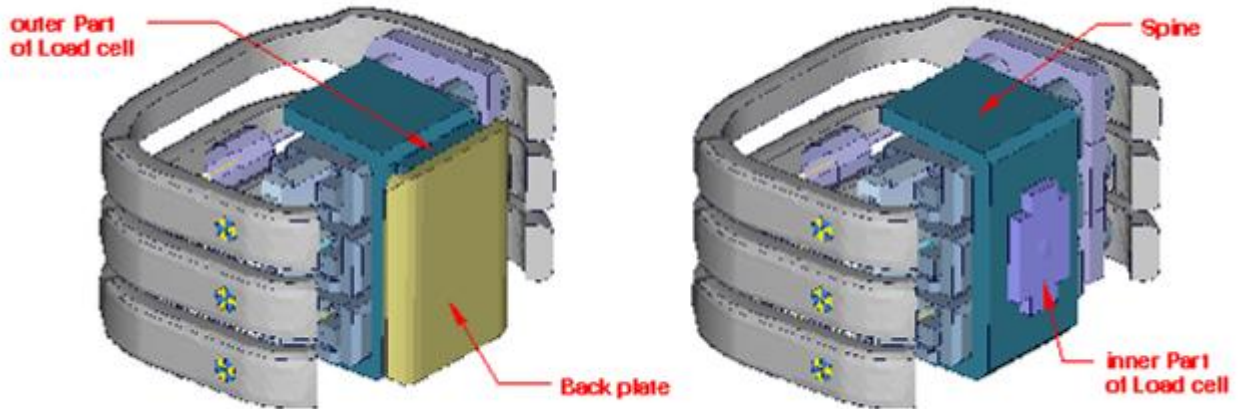

Figure 9: spine box with back plate

Figure 9 shows the spine box from back. The inner part of back plate load cell is connected to spine. The outer part is the adapter to the back plate. A discrete beam between both parts measures the forces and moments.

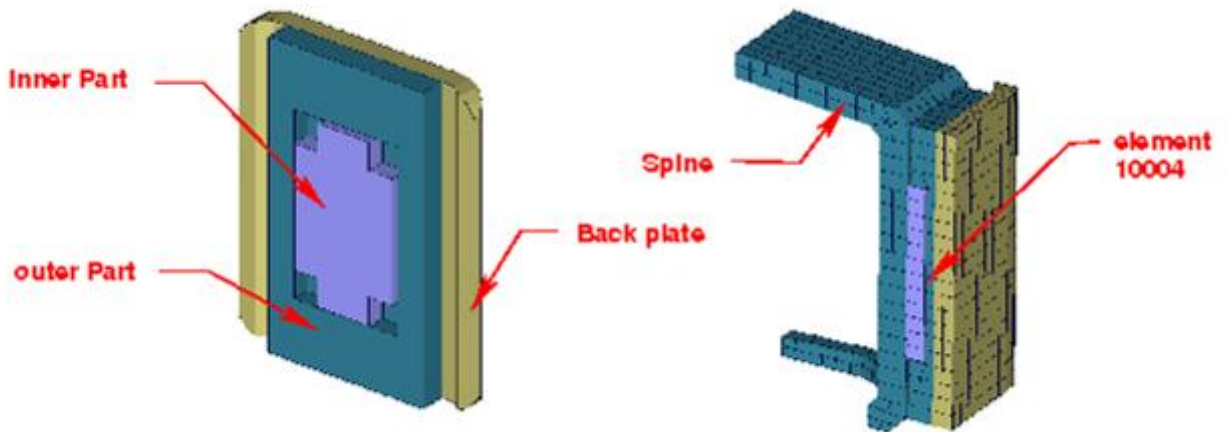

Figure 10: model of back plate load cell

Figure 10 shows the back plate assembly and a plane cut in y-direction. The discrete beam is located between the inner and outer parts of load cell. The local components to determine the forces and moments are shown in table below.

Item	Beam-ID	Label	Component
Back plate forces x-direction y-direction	10004	Back plate load cell	force axial shear-S
Back plate moment About z-direction	10004	Back plate load cell	moment moment-T

Table 17: Back plate forces and moment beam

3.9 Neck load cells

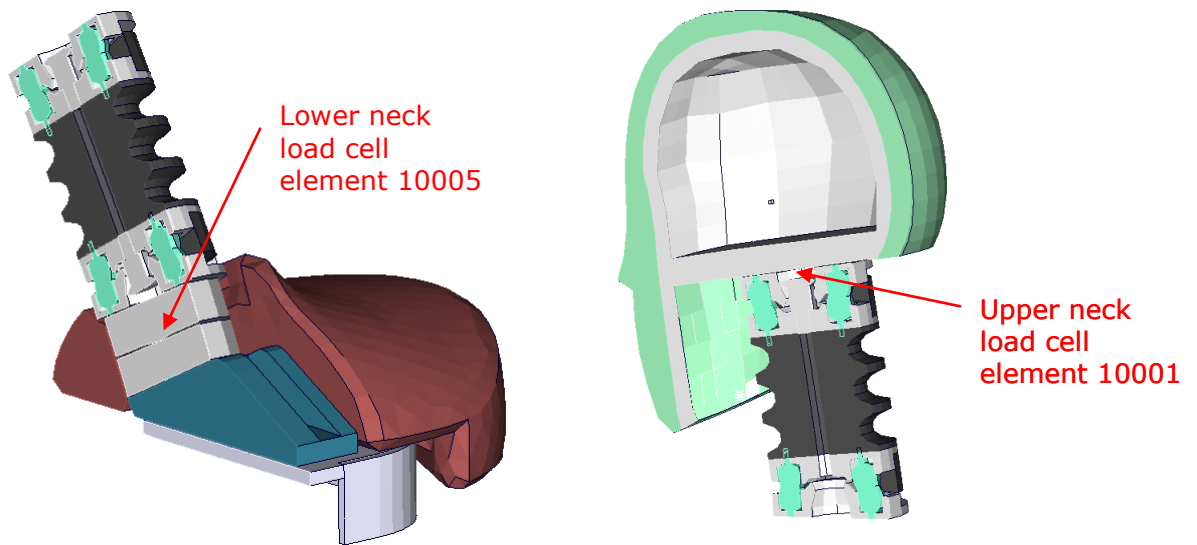

Figure 11: models of lower and upper neck load cell

Figure 11 shows the location of upper and lower neck load cell. Both are discretized as discrete beams. The table below gives details on the extraction of the loads.

Item	Beam-ID	Label	Component
Upper neck force y-direction	10001	upper neck load cell	force
Upper neck moment About x-direction	10001	upper neck load cell	shear-S moment
Lower neck force y-direction	10005	lower neck load cell	torsion
lower neck moment About x-direction	10005	lower neck load cell	force shear-S moment
			torsion

Table 18: Neck force and moment beams

3.10 T12 load cell (lumbar spine)

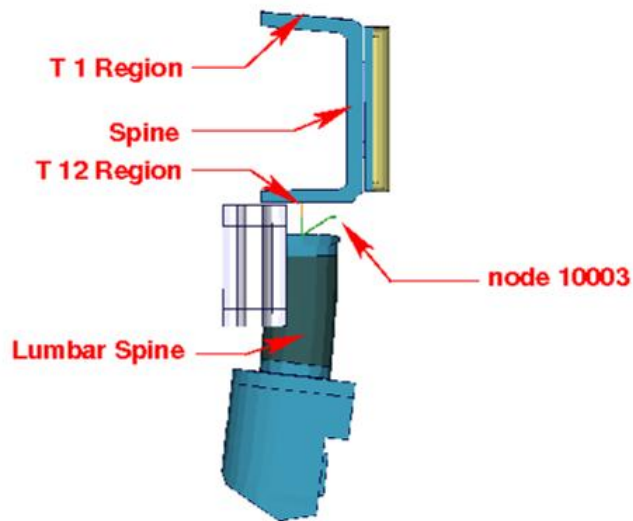

Figure 12: overview spine to sacrum with T12 load cell

Figure 12 shows the T12 area. The upper rigid beam is merged to spine and the lower rigid beam is merged to the upper lumbar spine adapter plate. Between the rigid beams a discrete beam is located to determine the T12- forces and moments. The local directions are shown in table below.

Item	Beam-ID	Label	Component
T12 force y-direction	10006	t12 load cell	force
T12 moment About z-direction	10006	t12load cell	shear-S moment torsion

Table 19: T12 force and moment beam

3.11 Lower lumbar load cell

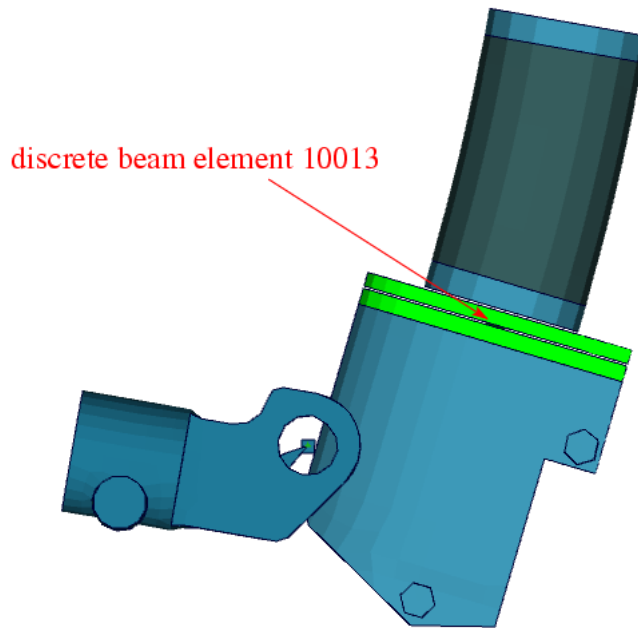

Figure 13: lower lumbar load cell

Figure 13 shows the lower lumbar area. Discrete beam element 10013 located in the lower lumbar spine area can be used to measure forces and moments. The local directions are shown in table below.

Item	Beam-ID	Label	Component
Lower lumbar force y-direction	10013	lower lumbar load cell	force shear-S
Lower lumbar moment About z-direction	10013	lower lumbar load cell	moment torsion

Table 20: Lower lumbar force and moment beam

3.12 Abdominal forces

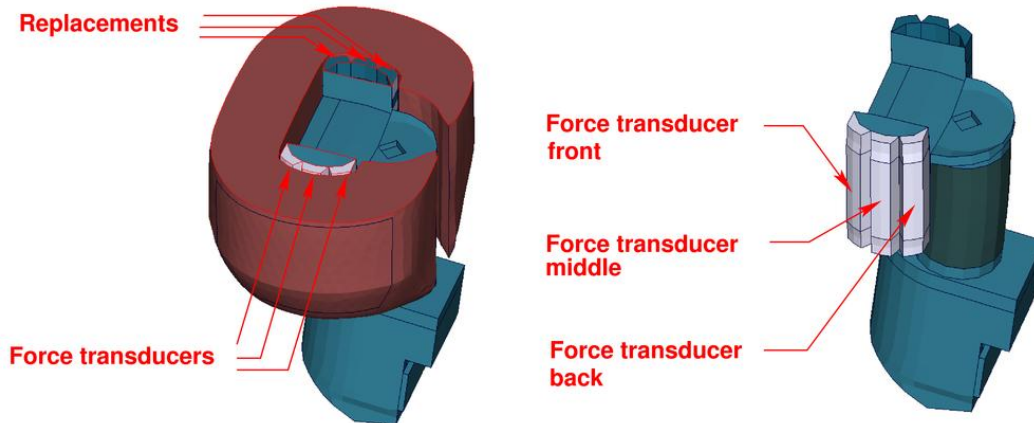

Figure 14: models of abdominal force transducers and replacements

The abdominal forces are determined by three load cells. Figure 14 shows the abdomen region. On the impact side the abdominal carrier is equipped with force transducers. On the other side replacements are located.

Three *CONTACT FORCE TRANSDUCER definitions are used in the model to represent the load cells. The title option is applied to find the interface number in the rforc. The 3rd contact definition is the front force transducer. The 4th and 5th definition are measuring for the middle and back force. The sum of the three forces is the abdominal resultant force.

Remark: A renumbering or adding further contact definitions in the run may change the numbering and has to be considered in Post processing.

Item	Interface-ID	Label	Component
Abdominal force front	Interface 3	ABDOMINAL FORCE – FRONT	Magnitude
Abdominal force middle	Interface 4	ABDOMINAL FORCE – MIDDLE	Magnitude
Abdominal force back	Interface 5	ABDOMINAL FORCE - BACK	magnitude
Abdominal resultant force	Interfaces 3+4+5		magnitude

Table 21: Abdomen interface forces

As a new feature of the ES-2 version 5.0 there are discrete beam element for the evaluation of the abdominal forces available. Thus, it is possible to model an uni-axial load cell.

Item	Beam-ID	Label	Component
Abdominal force front	10014	abdomen load cell front	shear-S
Abdominal force middle	10015	abdomen load cell middle	shear-S
Abdominal force back	10016	abdomen load cell back	shear-S

Table 22: Abdomen forces beams

3.13 Femur load cells

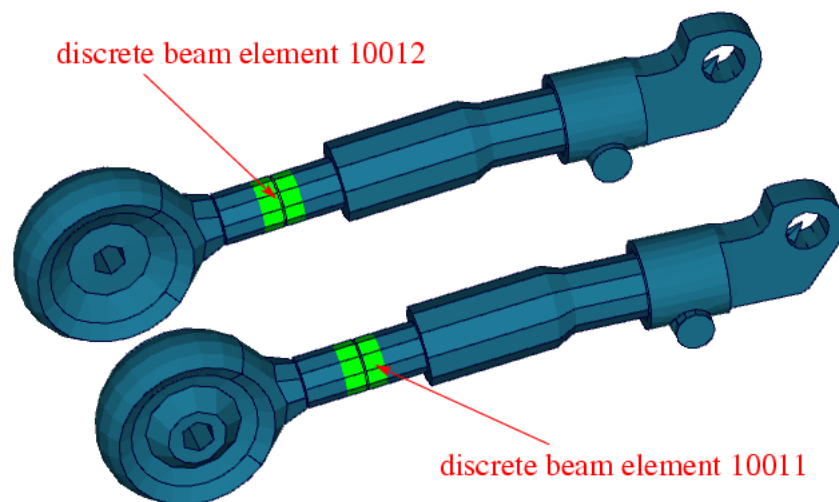

Figure 15: femur load cells

Figure 15 shows the femur area. Discrete beam elements 10011 & 10012 are located in the femur to determine forces and moments. The local directions are shown in table below.

Item	Beam-ID	Label	Component
Femur force left y-direction	10011	femur load cell leg left	force shear-S
Femur moment left about x-direction	10011	femur load cell leg left	moment torsion
Femur force right y-direction	10012	femur load cell leg right	force shear-S
Femur moment right about x-direction	10012	femur load cell leg right	moment torsion

Table 23: Femur forces and moment beams

3.14 ES-2re extension forces

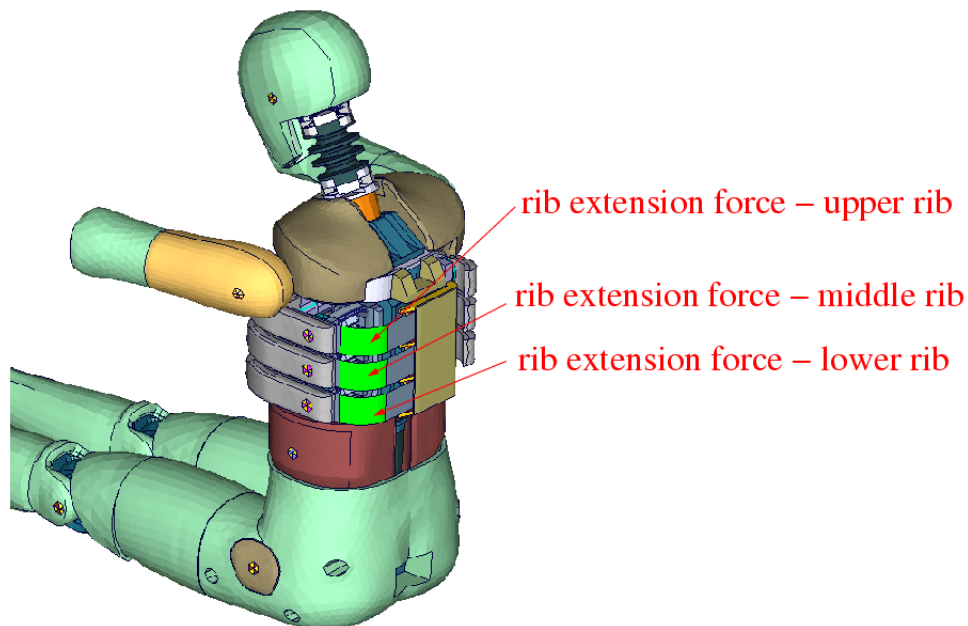

Figure 16: force transducer contacts of rib extension

Three *CONTACT FORCE TRANSDUCER definitions are used in the model to measure impact forces on the rib extensions of ES-2re model. The title option is applied to find the interface number in the rforc.

Remark: A renumbering or adding further contact definitions in the run may change the numbering and has to be considered in Post processing.

Item	Interface-ID	Label	Component
Extension force upper rib	Interface 6	RIB EXTENSION FORCE - UPPER RIB	magnitude
Extension force middle rib	Interface 7	RIB EXTENSION FORCE - MIDDLE RIB	magnitude
Extension force lower rib	Interface 8	RIB EXTENSION FORCE - LOWER RIB	magnitude
Extension resultant force	Interfaces 6+7+8		magnitude

Table 24: rib extension interface forces

4. Accelerometers

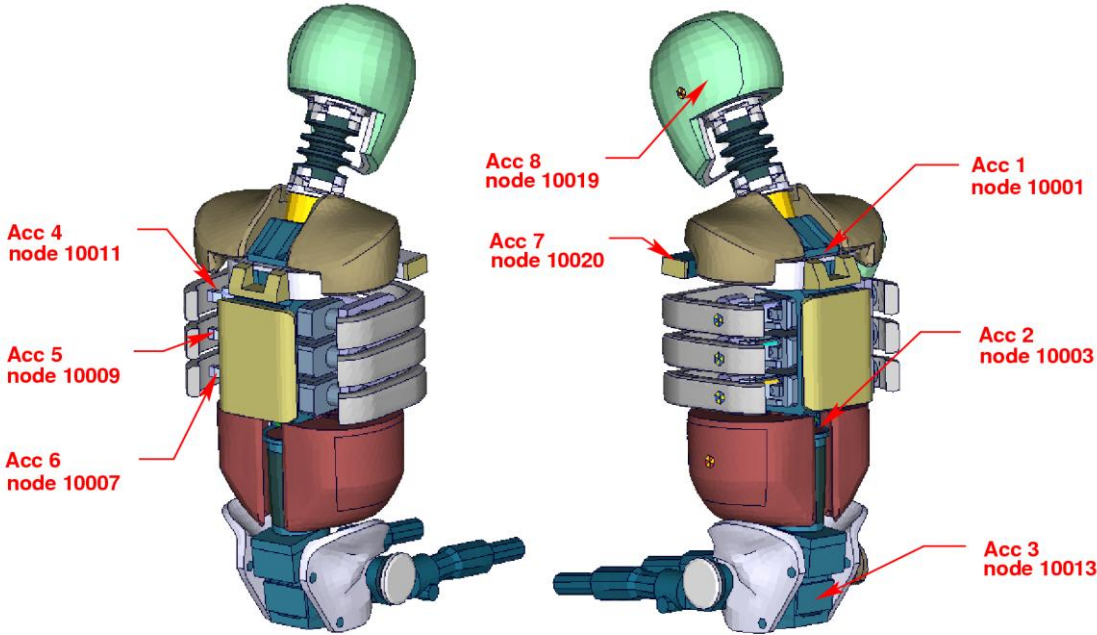

Figure 17: location of the accelerometers

Figure 17 shows the model from several views. The accelerometer and time history nodes are marked.

5. License file

The ES-2 v5.0 is distributed with a license file which uses an expiry date. The license file is sent to the user with the whole dummy package. Different license files are necessary for different systems of units.

In the license file, all load curves are encrypted. There are parameters defined which can be used to offset the numbering of the load curves. The load curves can be scaled by using parameters which are encrypted in the normal ES-2 input. The names of the parameters refer to the table or load curve ID of each material. So if the values of the table ID 1002 are to be scaled then the parameter s1002 must be used.

The principle structure is as follows:

Input data of the ES-2 file:

```
*PARAMETER
$ Load Curve offset
I lcoff          0

$ Load Curve scale values
R sTABID        1.0
.
.
.
```

Input of the license file:

```
*PARAMETER_EXPRESSION
I lcTABID      TABID + &lcoff
R eTABID       1.0 * &sTABID

*DEFINE_CURVE
&lcTABID      0          1.0&eTABID      0.0      0.0
              <Values_x>    <Values_y>
.
.
.
```

The license file must be included like a normal include file. But it is necessary that the license file is included **AFTER** the ES-2 file. LS-DYNA has to first read the ES-2 input data and then the PARAMETER_EXPRESSION in the license file. Otherwise LS-DYNA will terminate with an error because of missing parameters.

The expiry date, the owner of the license and the system of units are printed out in the d3hsp file of LS-DYNA. The name of the license file also includes the company name and the expiry date of the dummy.

For the work in a pre-processor, an additional file is delivered:

es2_v5.0_mm_ms_kg_load_curves_work.key

This work file includes the same input as the encrypted license file. The only difference is the scaling of the load curves in the work file. The load curves are scaled randomly in a wrong range and they are much too soft to be used for a LS-DYNA simulation. But the file can be used to observe the quality and course of the material curves.

A LS-DYNA simulation in use of the work file will give wrong results and is very unstable.

6. Incorporating the dummy in vehicle models

6.1 Positioning, tree file

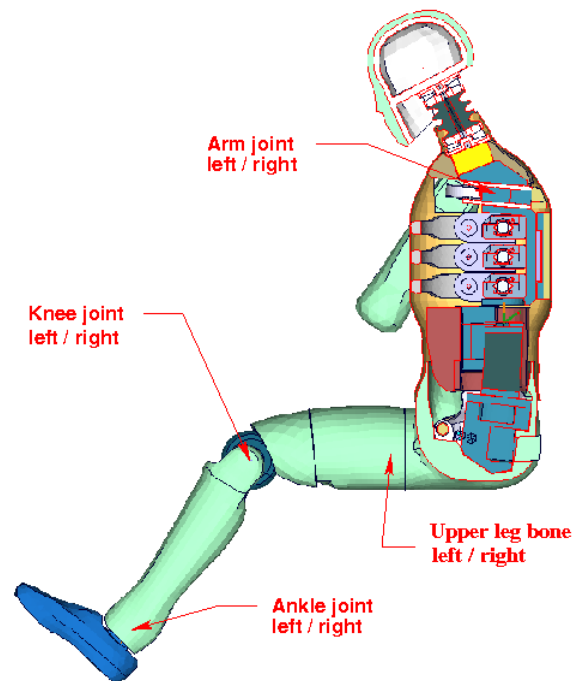

Figure 18: cut through the model with joints

The ES-2 model is delivered with a tree file for the Primer and LS-Prepost pre-processors (may work also for HyperMesh and ANSA, not verified by DYNAmore). This allows the user to position the dummy and adjust the parts according to their degree of freedom. Figure 18 shows the connections of movable parts via tree file.

The accompanying local coordinate systems are shown in **Fehler!**

Verweisquelle konnte nicht gefunden werden.. All revolute joints are visualized by beams.

In the H-Point of the dummy model two coordinate systems are modeled. These coordinate systems are connected to each other by a spherical joint. One coordinate system is connected to global directions, e.g. only translations are possible, rotations are disabled. The other one is connected to the dummy, so it is possible to measure quickly and easily the pelvis angle of the ES-2 during the positioning simulation. These coordinate systems are also used to determine the initial pelvis angle with Primer.

Movable parts and revolute joints are:

- Foot, left and right about their ankle joints (stop angle: -30.0 and +30.0 degree)
- Lower leg, left and right about their knee joints (stop angle: -7.0 and 90.0 degree)

- Upper leg bone, left and right about x-axis
(stop angle: -40.0 and +40.0 degree)
- Upper leg bone, left and right about hip joints in y-,z-axis
(stop angle y-axis: -5.0 and 5.0 degree)
(stop angle z-axis: -1.0E-4 and 5.0 degree)
- Right arm about its arm joint
(no stop angle)

Due to the continued modeling of the dummy jacket around the left shoulder, the rotation of the left arm by a preprocessor is obsolete. The rotation of the arm has to be done by a pre-simulation.

If the upper legs are rotated at the hip joints, initial penetrations would occur. This reaction is based on the hardware. In the hardware, the geometry is deformed if the position of the upper leg is changed with respect to the pelvis. That is the reason why the degrees of freedom for the upper legs are disabled in Primer tree-file. It is recommended to position the upper legs by a pre-simulation. A special positioning-file <positioning_es-2_v4.1_(re_1.0)_mm_ms_kg.key> is delivered to do this pre-simulation.

The positioning-file of ES-2 is very easy to use. At the top of this file you will find a set of parameters you have to set. These parameters are shown in the following table.

Parameter	Description
term	termination time
tmove	time to move parts
trans_x	x-translation of the whole dummy
trans_y	y-translation of the whole dummy
torsor	local y-rotation of torso
lfemry	left femur rotation about y
rfemry	right femur rotation about y
lfemrz	left femur rotation about z
rfemrz	right femur rotation about z

Table 25: positioning file parameters

In case you do not want to translate or rotate an assembly use a very small value like 1.0E-10. Please do not use zero as value, because zero as scaling factor is default 1 in LS-DYNA. As second step you have to add your include-files necessary for positioning the dummy model.

Usually only seat and dummy models are used for the positioning procedure. Please define a *CONTACT AUTOMATIC SURFACE TO SURFACE for the contact between the dummy and seat (environment). The ES-2(re) properties for this contact are prepared in the part set 1500.

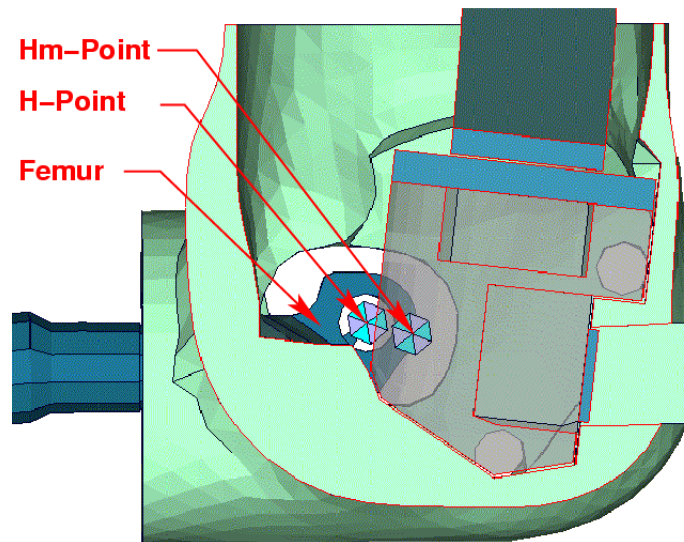

Figure 19: location of H- and Hm-point

Figure 19 shows the location of H- and Hm-Point. More details are give in the "User Manual ES-2; 2002, FTSS Inc.".

Following Nodes are used:

- The node 10200 is located at the H-Point.
- The Hm-Point, determined by the HIII Manikin, is located at node 10201.

The delivered coordinates are:

Location	x-coor	y-coor	z-coor
H-Point	-21	0	5
Hm-Point	0	0	0

Table 26: H-Point coordinates

6.2 Measuring of pelvis and torso angle

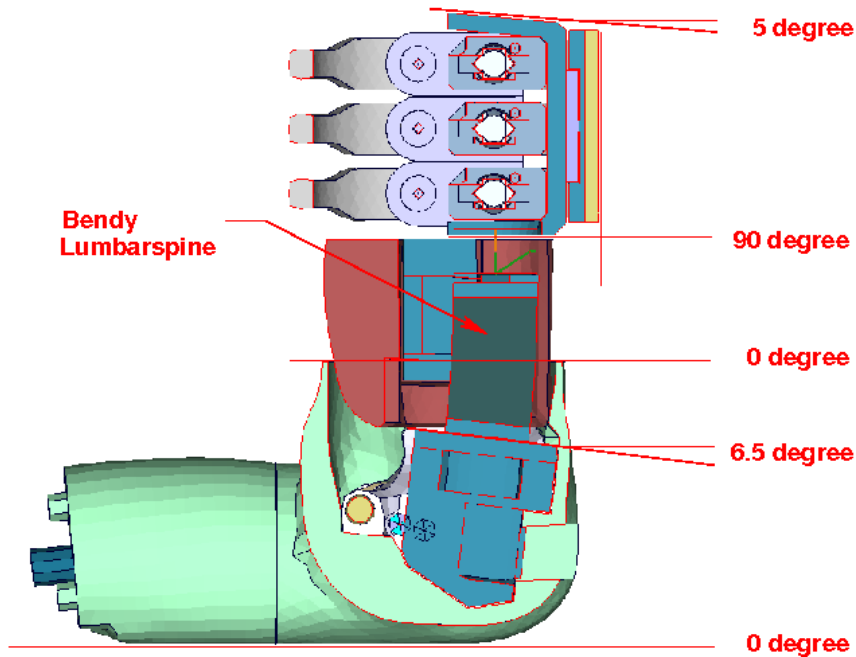

Figure 20: angles of important edges of the ES-2 dummy

Figure 20 shows the model in an upright position. The sacrum block and the spine box are rotated according to a 3D measurement of the fully assembled model.

There are different ways to measure the pelvis- and torso angle in the hardware model.

Angle	Device	Angle in upright position
Pelvis angle	Tilt sensor	6.5°
Torso angle	H-Point device	0.0°
	Tilt sensor	5.0°
	Measure at back plate	0.0°

Table 27: dummy angles

In the software model following parts should be used to identify pelvis- and torso angle.

Angle	Parts	Angle in upright position
Pelvis angle	Between PID 233 & 234	0.0°
Torso angle	Measure at back plate PID 55	0.0°

Table 28: dummy model angles

6.3 Numbering

- Nodes in the range of 10.000 to 11.000 are used for joints, accelerometers, etc. definitions.
- Nodes with node IDs above 11.000 are used only in *NODE and *ELEMENT cards.
- Elements in the range of 10.000 to 11.000 are used for history, discrete elements, etc. definitions.
- Elements with IDs above 11.000 are used only in *ELEMENT cards.

6.4 Contact definition

Dummy to Vehicle and Seat:

For the contact of the dummy model to the vehicle and the seat an automatic surface to surface contact is proposed. For this contact definition a property set (*SET PART, id: 1500) has been prepared in the dummy input-file. This property set includes all properties of the ES-2(re) model which are necessary for the dummy to environment contact definition.

The usage of a single surface contact is not recommended. This might interfere with the contact definitions of the dummy model itself. To remove the dummy model from used automatic single surface contact a second property set (*SET PART, id: 1501) has been prepared. This property set includes all properties of the dummy model, so it can be added easily to a used exclude list of the automatic single surface contact for whole vehicle.

The following figure depicts properties used in property sets 1500 & 1501:

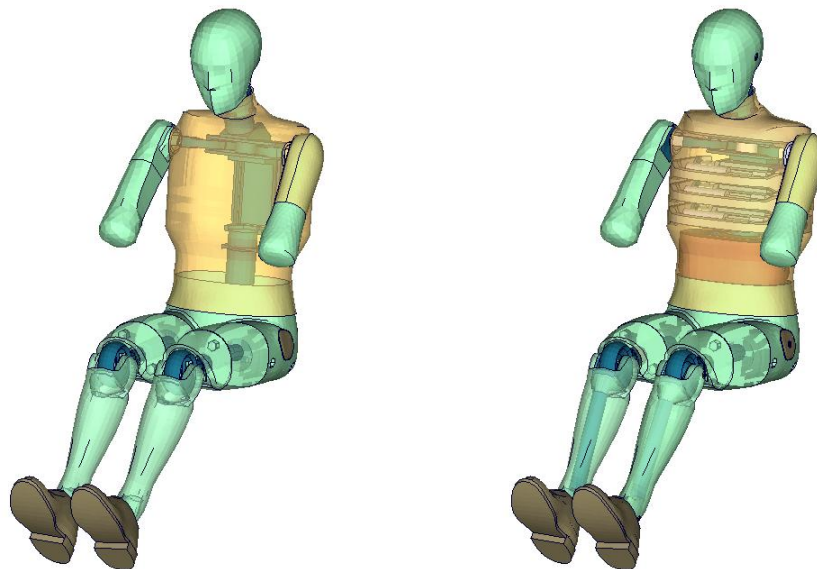

Figure 21: parts used in contact definition

The following table gives the part numbers used in property set 1500.

Item	Part-ID	Item	Part-ID
Head	65	Upper leg, left	158
Head	66	Upper leg, right	168
Jacket inner sleeve	24	Lower leg, left	174
Left Arm	3	Shoe, left	224
Right Arm	88	Shoe, right	178
Pelvis plug, right	133	Knee, left	179
Pelvis plug, left	134	Knee, right	184
Pelvis skin	136	Lower leg, right	226
Jacket	140	Shoe, right	188
Jacket outer sleeve	141	Contact shells	189
Jacket shoulder		Opt. contact shells	280

Table 29: properties for external contact

Optional Contact Shells:

A separate property (PID 280) has been defined. This property is used for nullshell elements closing physical gaps of the dummy model (for example between pelvis and jacket). DYNAmore prepared a separate include file. This include file is called es2 v4.1 nullshells.inc, it includes nullshell elements of property 280. These nullshells can be helpful for some contact problems of dummy to environment contact. The usage of this contact shells is optional and will not change the results of the ES-2 barrier tests. The figure 25 shows the nullshell contact elements (red-colored).

6.5 Additional remarks

- The modification of the *CONTROL cards of the dummy file may have influence on the performance and robustness of the model. Therefore, the *CONTROL cards of the dummy models are proposed for integrated simulations as well. Important flags on LS-DYNA control cards:
 - *CONTROL ACCURACY flag INN=2
 - *CONTROL BULK VISCOSITY flag TYPE=-1
 - *CONTROL SHELL flag ESORT=1
 - *CONTROL SOLID flag ESORT=1
- The model should be used with a time step size of 1 microsecond or less!
- If a model for right side impact is needed, please contact DYNAmore. RHD models in both systems of units are available.
- All nodes are connected to an element.
- No mass less nodes are in the input files of the dummy
- The model is free of initial penetrations.

7. Release notes from v4.5 to v5.0

The following major modifications are made:

7.1 Geometric modifications

- The dummy model now provides identical arm models and a complete new mesh of the head. The jacket is closed on both shoulder areas. Furthermore it is expanded in the front and back and connected to the pelvis flesh.
- The legs of the dummy are completely remodeled

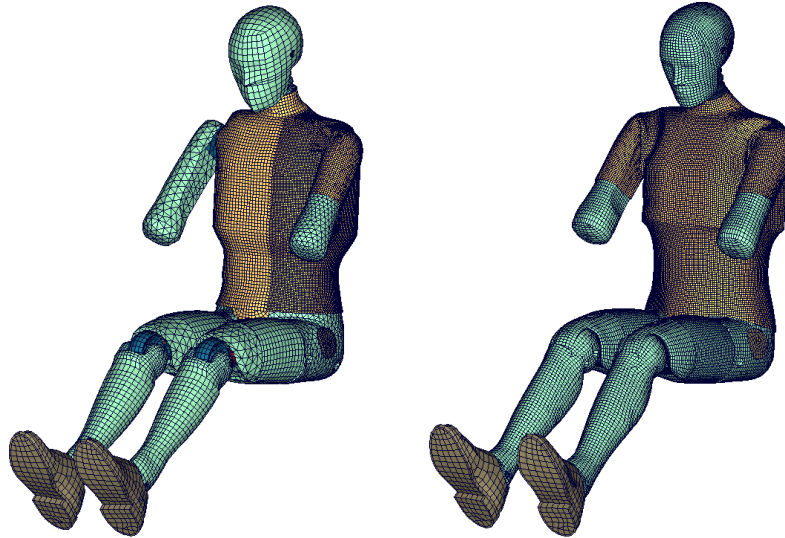

Figure 22: ES-2 v4.5 (left) and v5.0 (right)

- There is a new mesh of the clavicle box and the arm. Both consist of hexahedron elements.

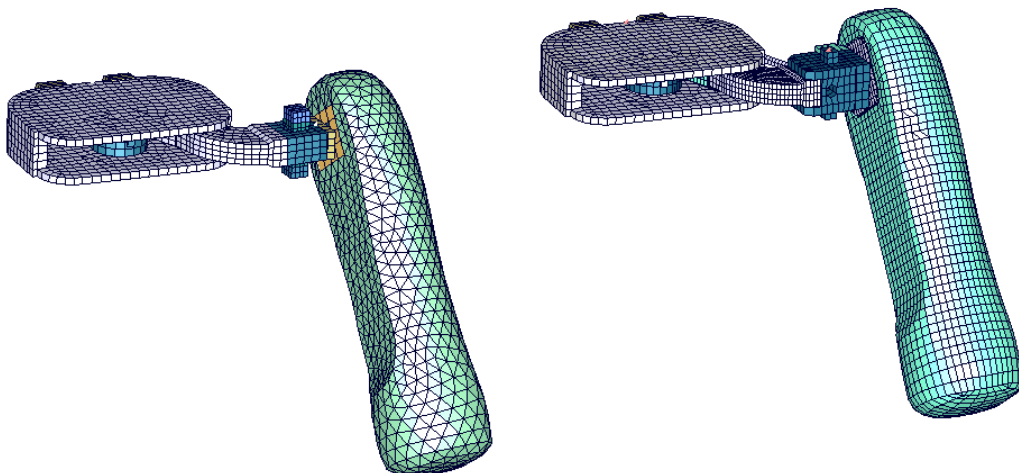

Figure 23: ES-2 v4.5 (left) and v5.0 (right) clavicle box and arm

- New mesh of the inner pelvis assembly now includes screw heads, spacers and washers.

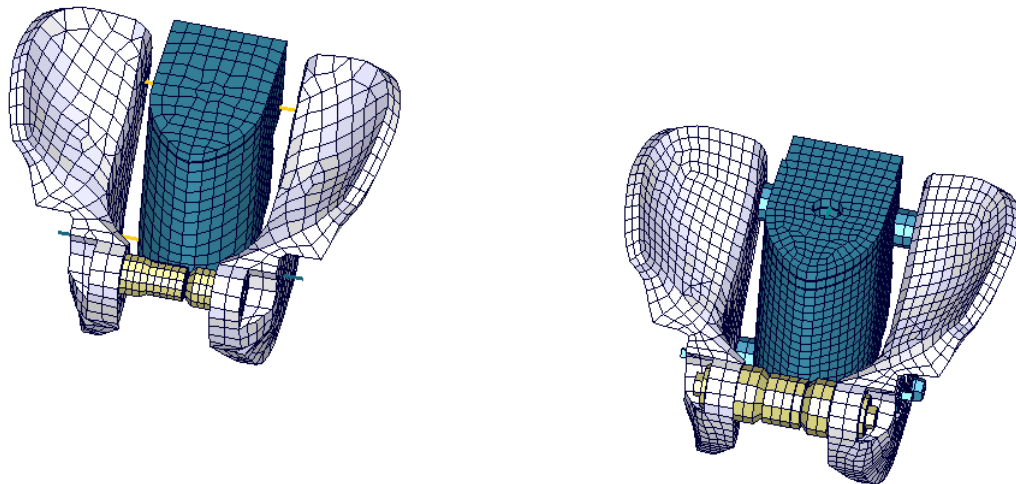

Figure 24: ES-2 v4.5 (left) and v5.0 (right) inner pelvis assembly

7.2 Non-geometric dummy model modifications

- The update contains a lot of new material data which comes from a new series of tests
- The following materials were tested and included to the model v5.0
 - Shoulder foam
 - Clavicle plastics
 - Upper/lower arm foam
 - Arm bone plastics
 - Lumbar spine rubber
 - Iliac wing plastics (same as clavicle plastics)
 - Pelvis back plate buffer
 - Femur stopper rubber

7.3 Additional remarks

- Validation and calibration test models were improved

8. Limitations and further work

The step from v4.5 to v5.0 was the biggest step in the model evolution of the DYNAmore ES-2(re) model. The majority of the dummy parts were completely remodeled. Now any geometric detail is provided by the model. Furthermore all key-materials (rubbers, foams and plastics) were included by state of the art material models. These material models were defined by using new material test data provided by the PDB (Partnership for Dummy Technology and Biomechanics).

Chapter 10 of the FE-manual describes the conducted component tests and the corresponding model performance. There is not much space left for improving the model on component level.

For the following releases DYNAmore plans to include all gathered user feedback of ES-2 v5.0. In addition to that ongoing enhancements of the barrier test performance will be done.

9. Performance on component level

9.1 Component Tests

9.1.1 Arm Test

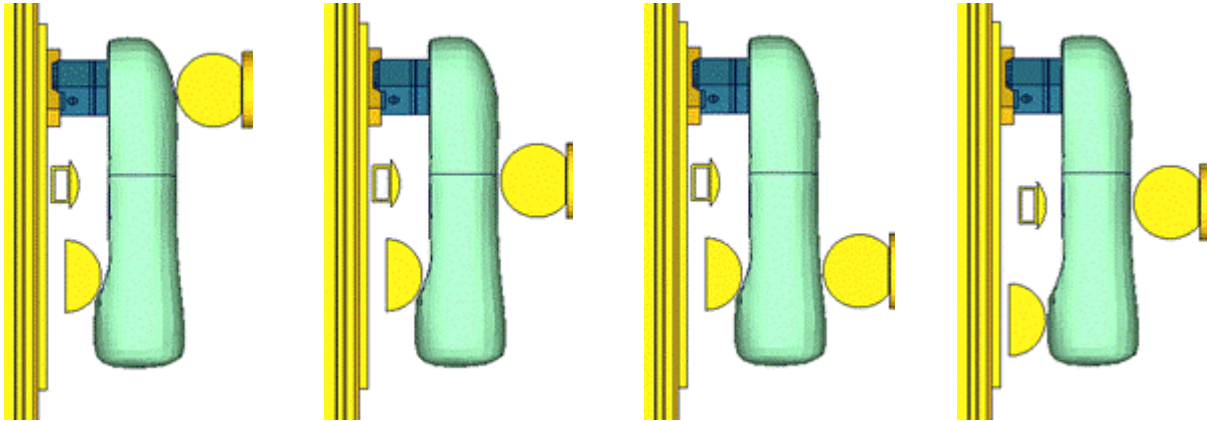
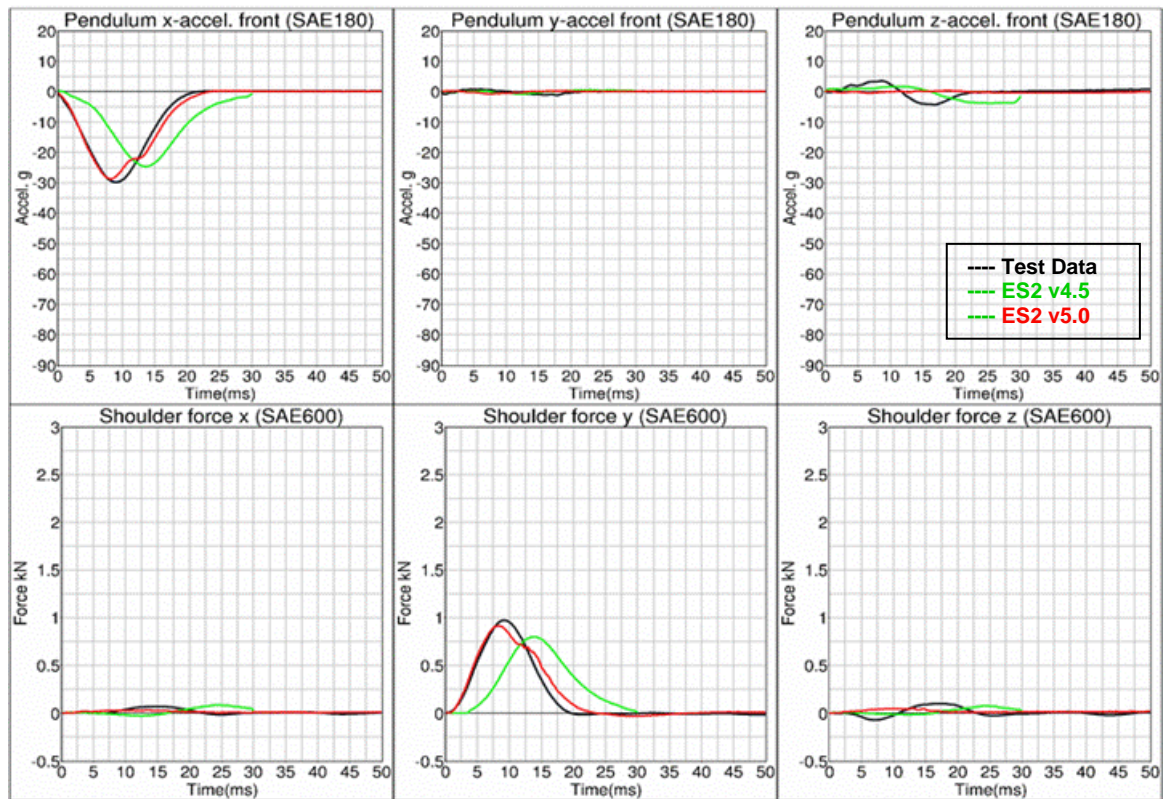

Figure 25: Test setups for Arm test

The arm of the ES2_v5.0 now has an arm bone modeled with solids and a new mesh for the arm flesh. The bone and arm foam are separated in the arm. We also have a completely new modeled arm joint and a new mesh for the load cell. The test setup for the arm test is shown in the figure above. The arm is impacted with a pendulum at 3 different positions with 2 different velocities each. An additional modified configuration is used wherein the arm is impacted at the mid-position with 2 velocities.

Results for top impact , low velocity



Results for top impact , high velocity

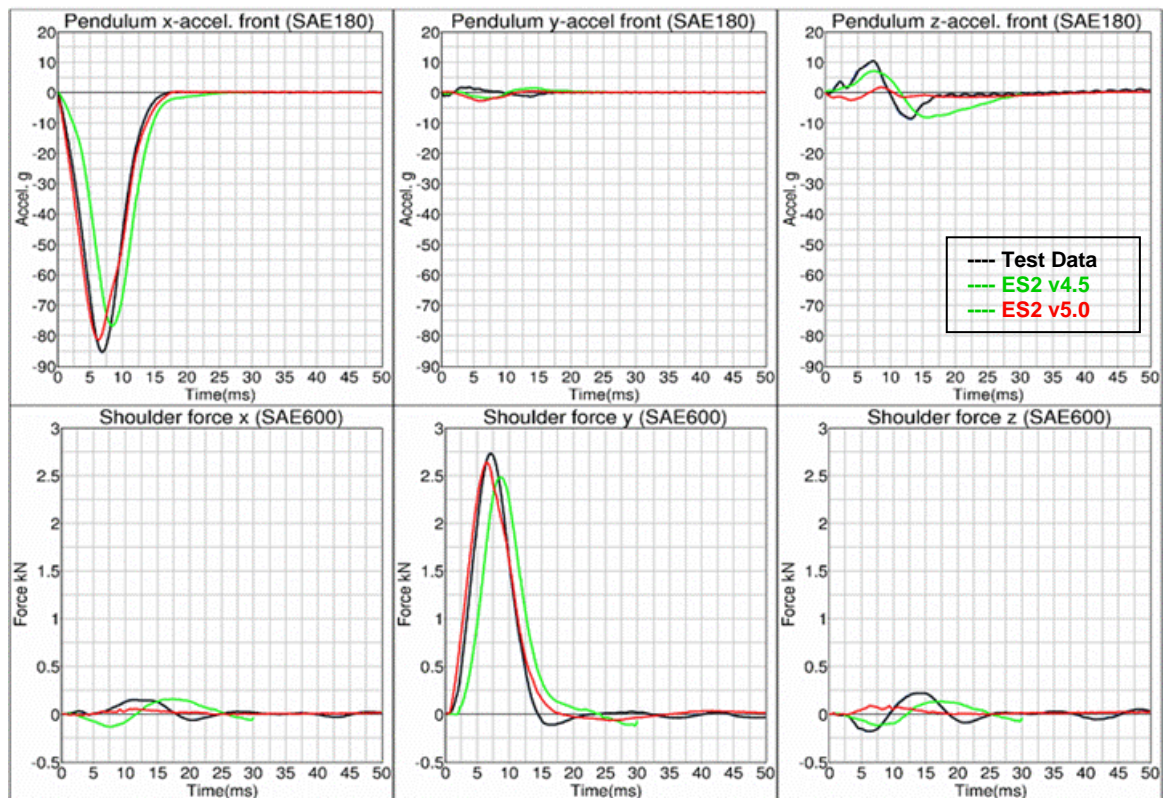

Results for mid-position impact , low velocity

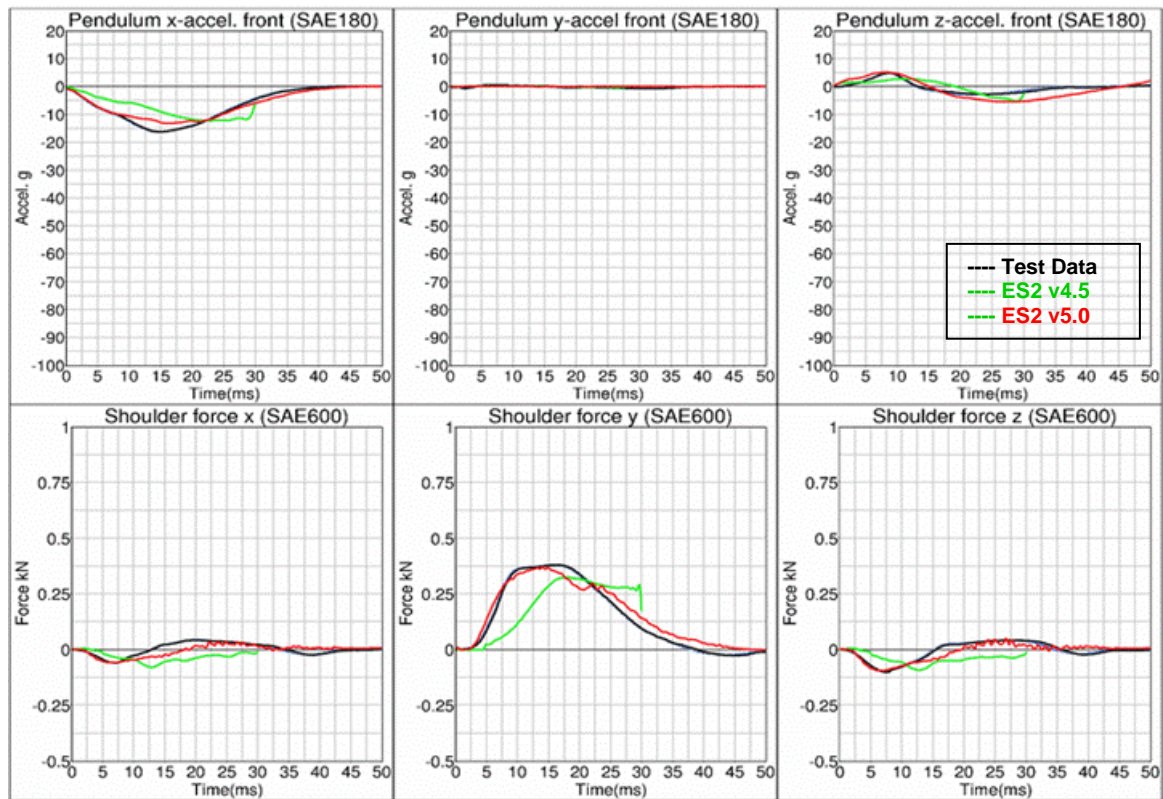

Results for mid-position impact , high velocity

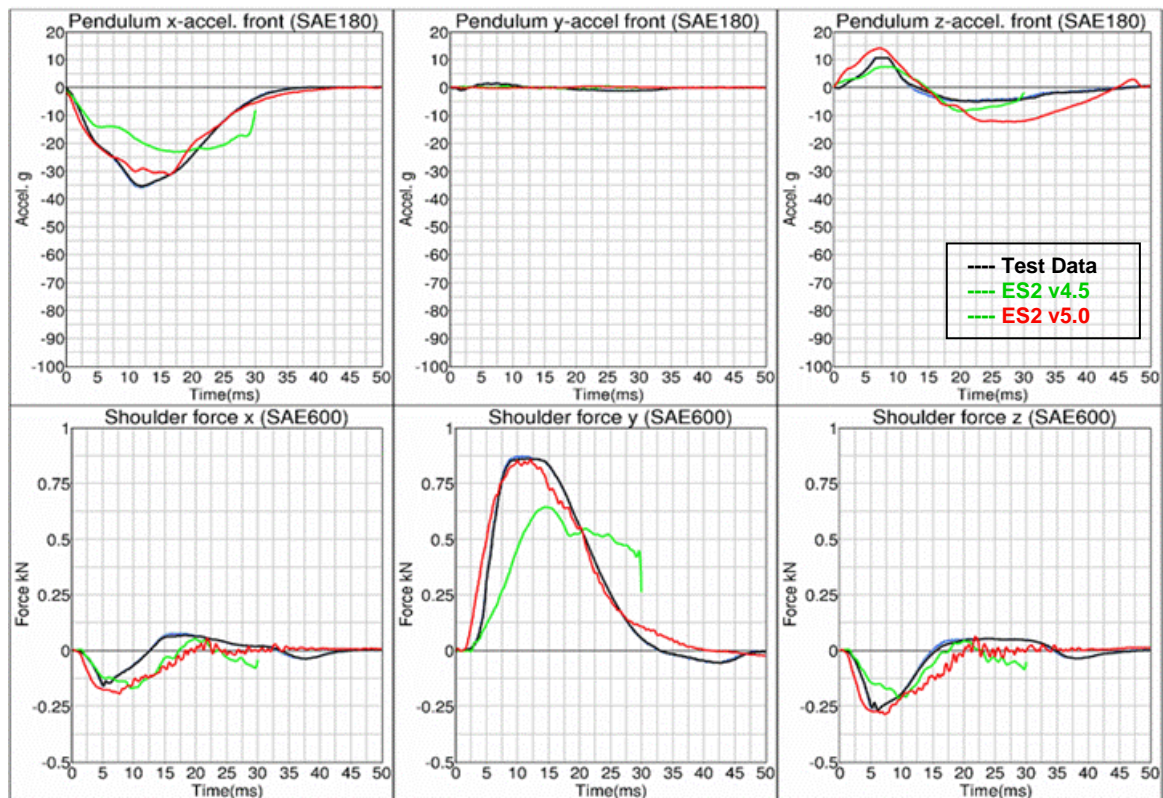

Results for bottom impact , low velocity

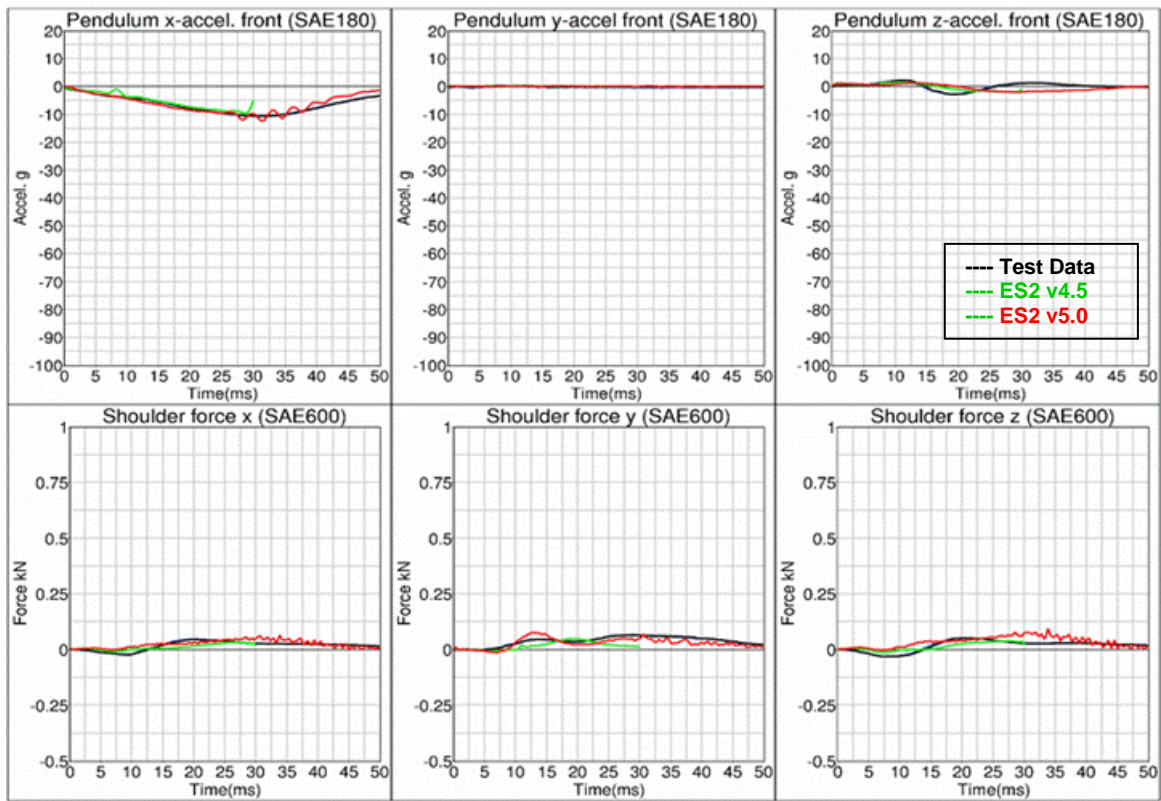

Results for bottom impact , high velocity

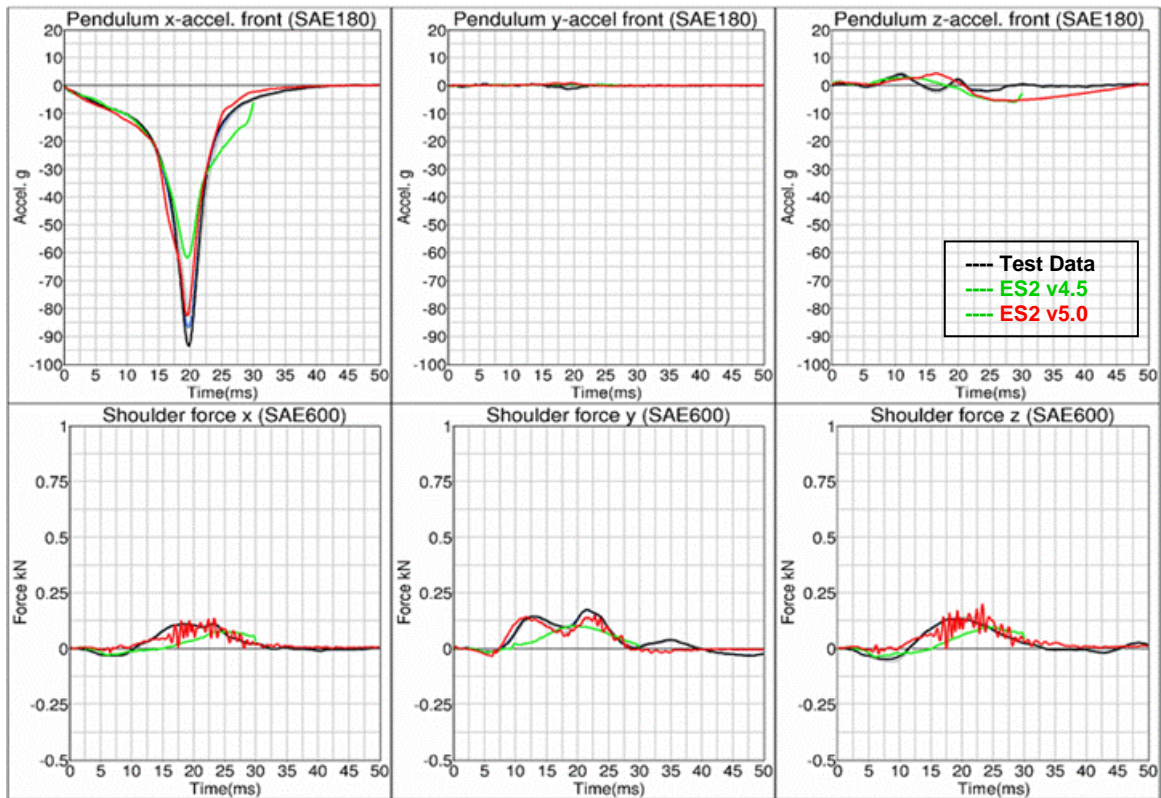

Results for mid-position impact , low velocity (Add. configuration)

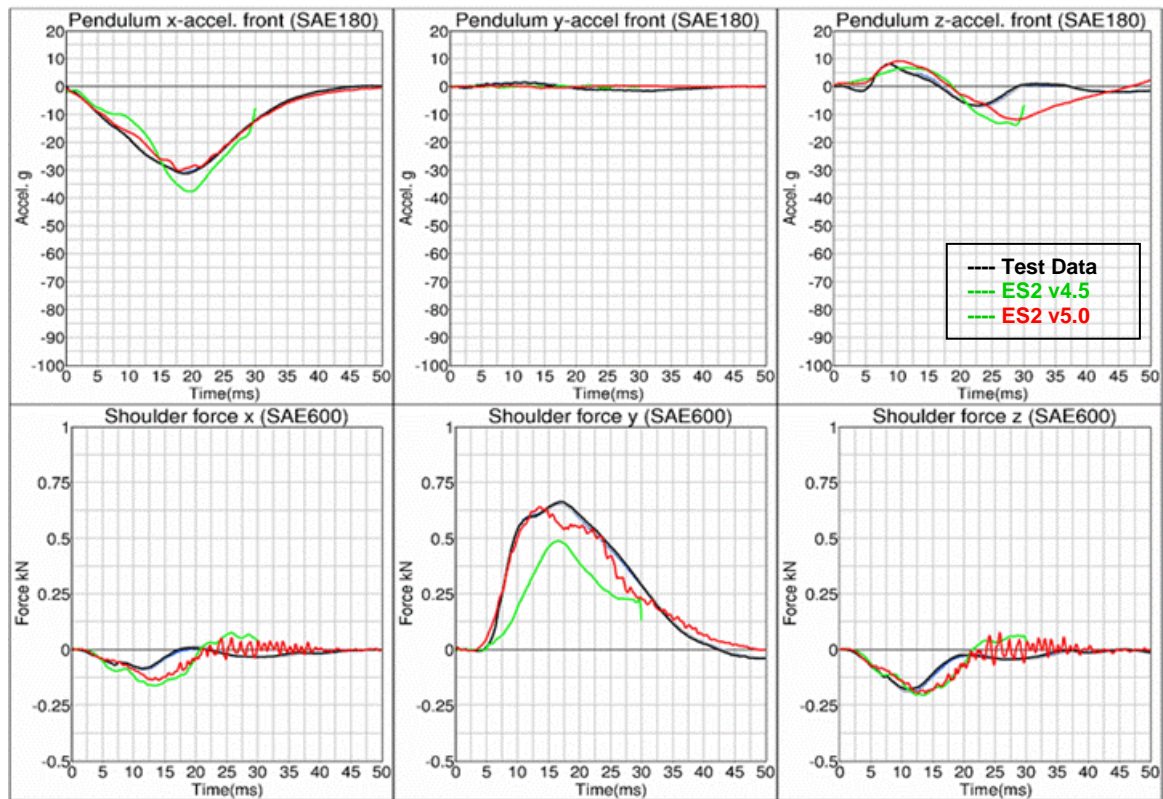

Results for mid-position impact , high velocity (Add. configuration)

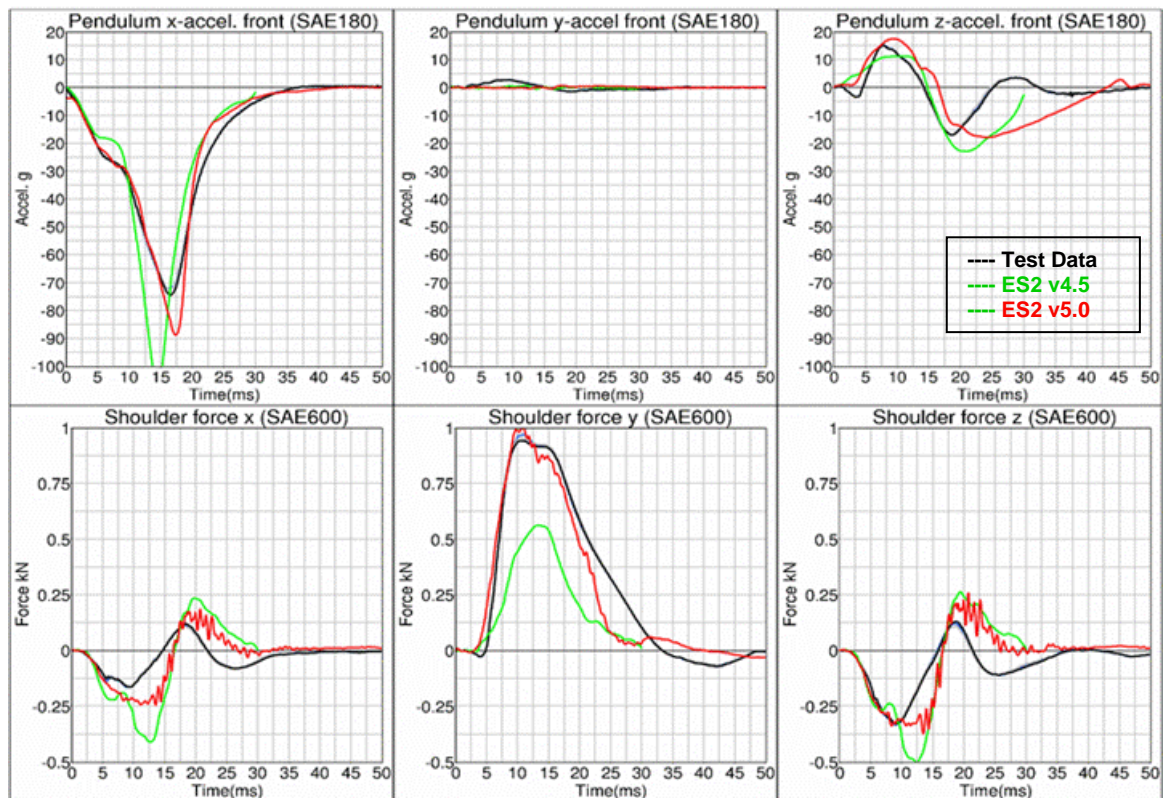

9.1.2 Clavicle test

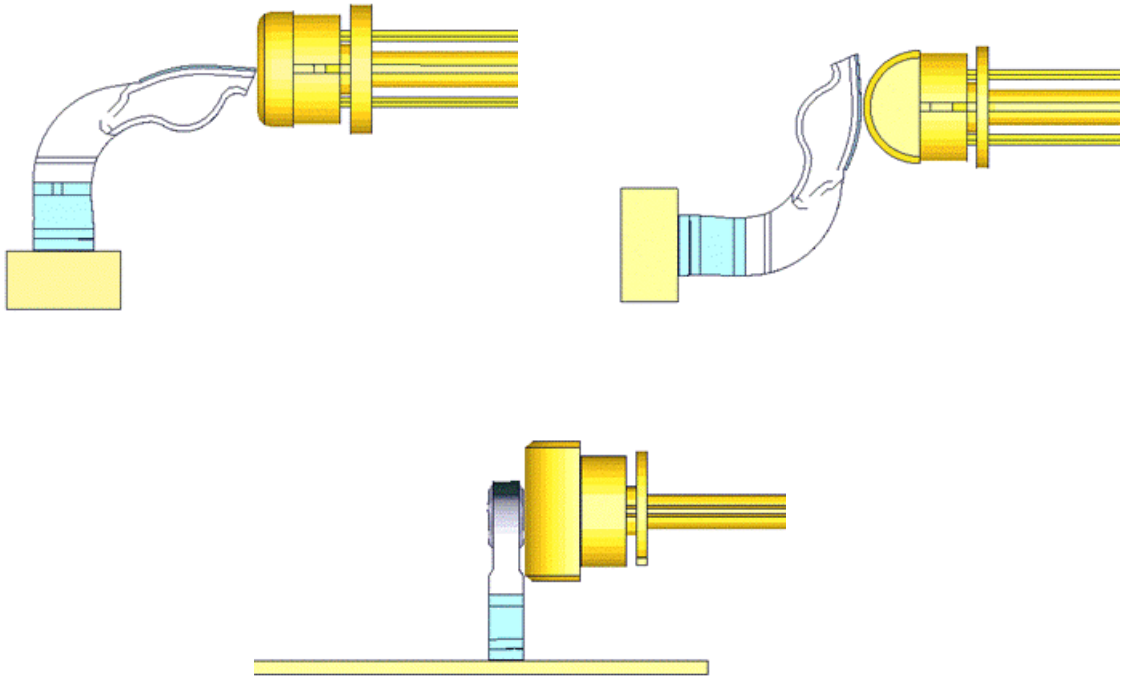
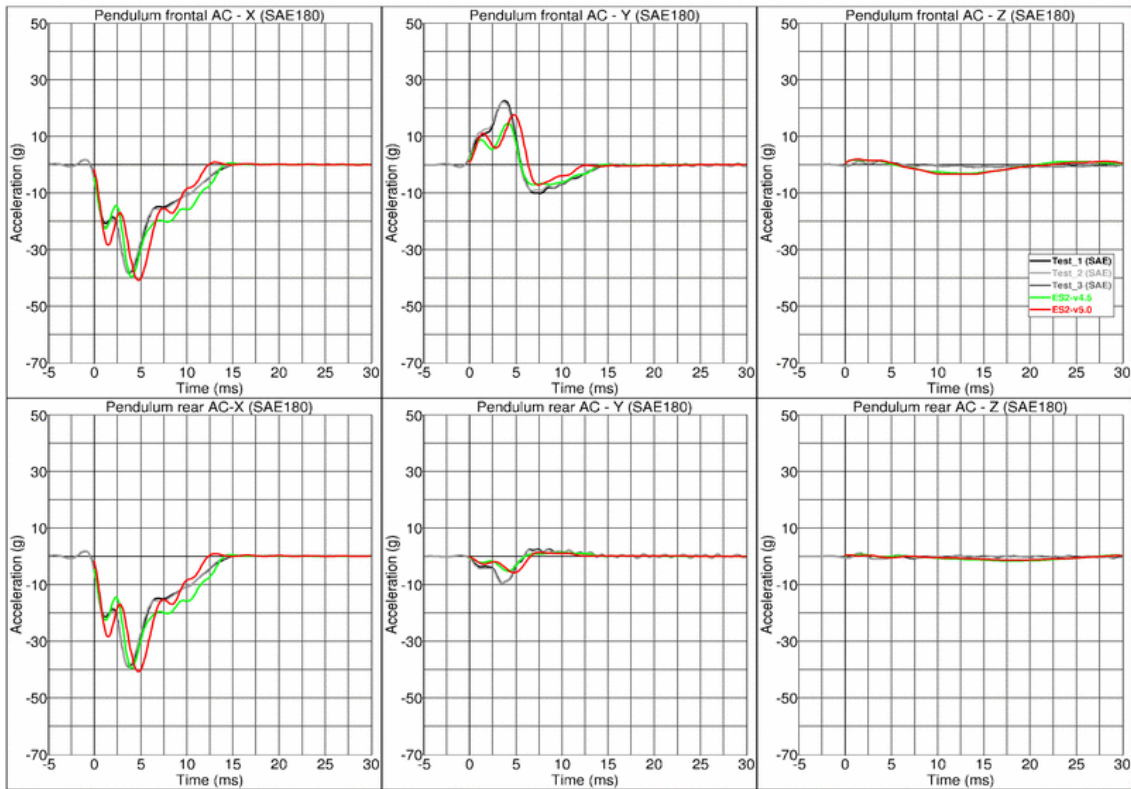

Figure 26: Clavicle test: Pendulum impact on Clavicle in x- , y- and z-direction respectively

In the clavicle test, the clavicle is impacted by a pendulum in 3 different directions with 2 velocities each. The test setup for the 3 different directions of impact are shown in the figure above.

Results for X-direction impact , low velocity

Clavicletest, x-Richtung, Low velocity



Clavicletest, x-Richtung, Low velocity

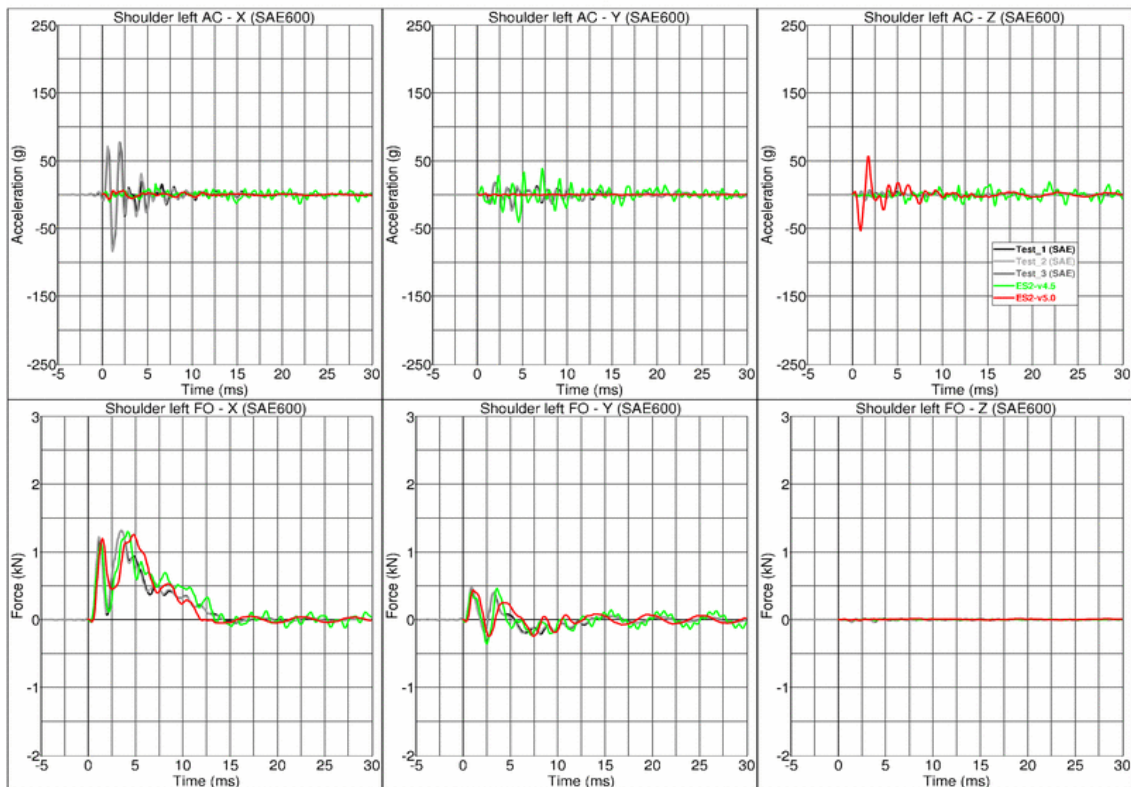

Results for X-direction impact , high velocity

Clavicletest, x-Richtung, High velocity

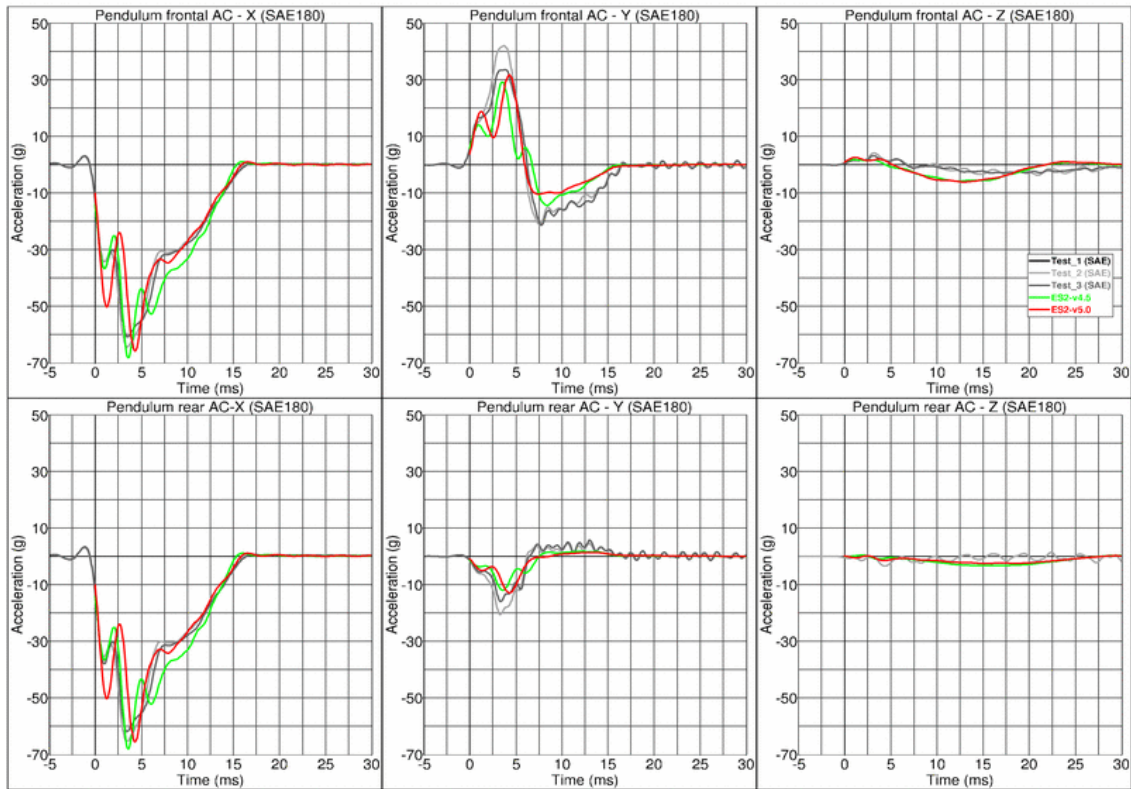

Clavicletest, x-Richtung, High velocity

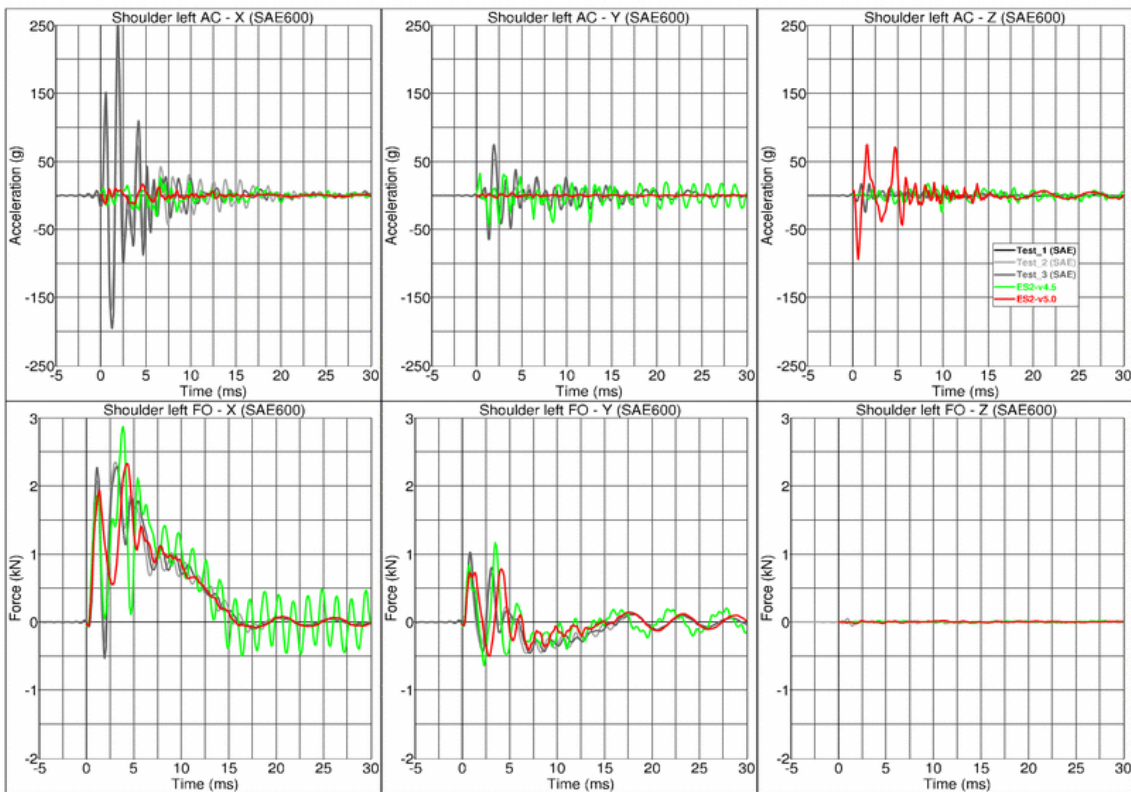

Results for Y-direction impact , low velocity

Clavicletest, y-Richtung, Low velocity

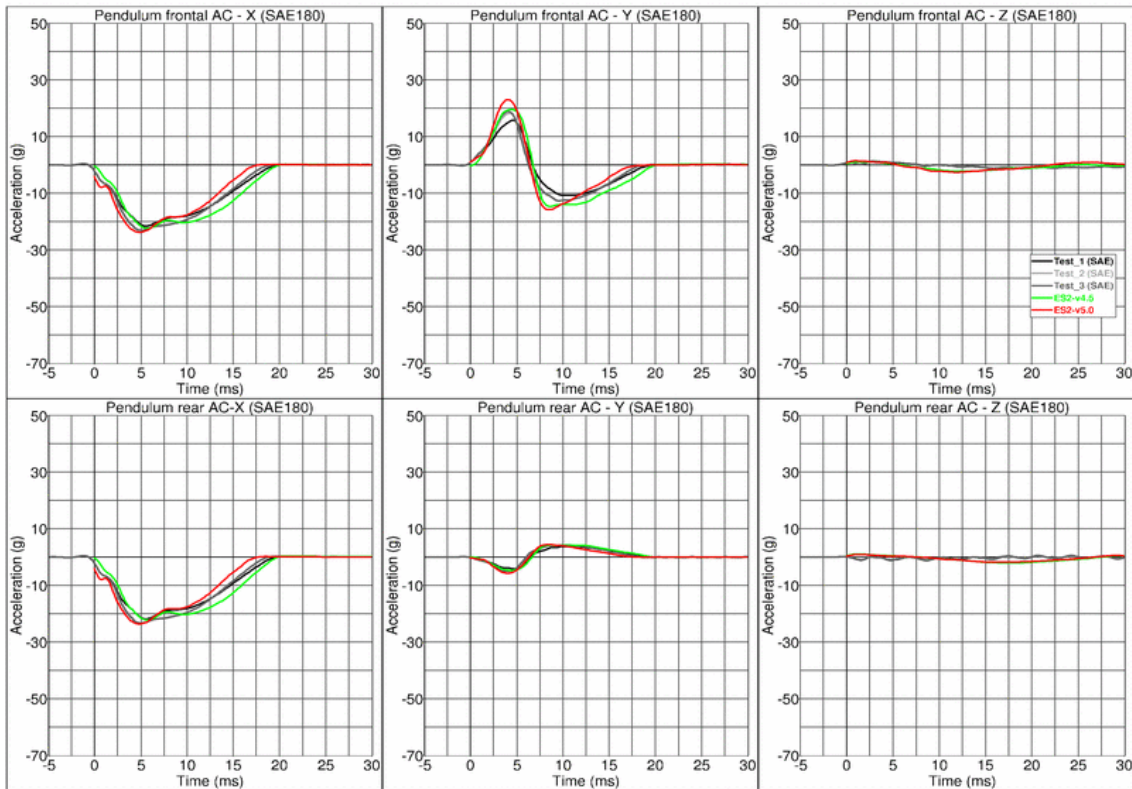

Clavicletest, y-Richtung, Low velocity

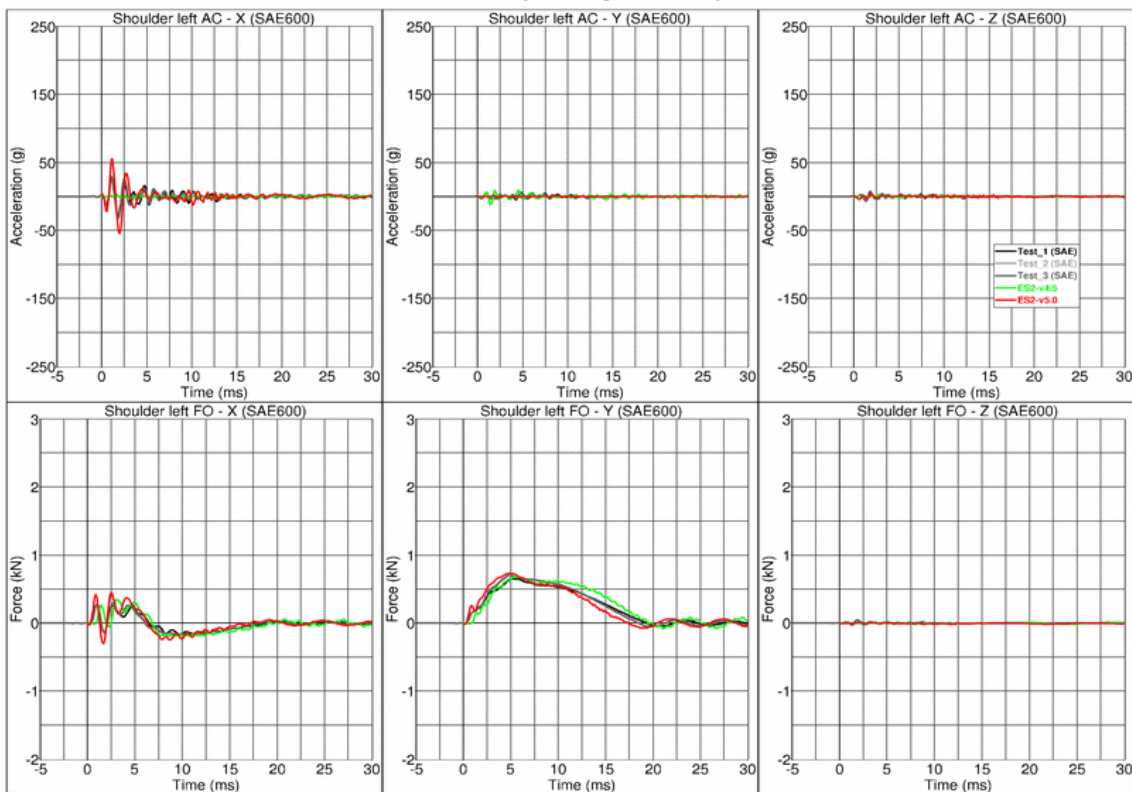

Results for Y-direction impact , high velocity

Clavicletest, y-Richtung, High velocity

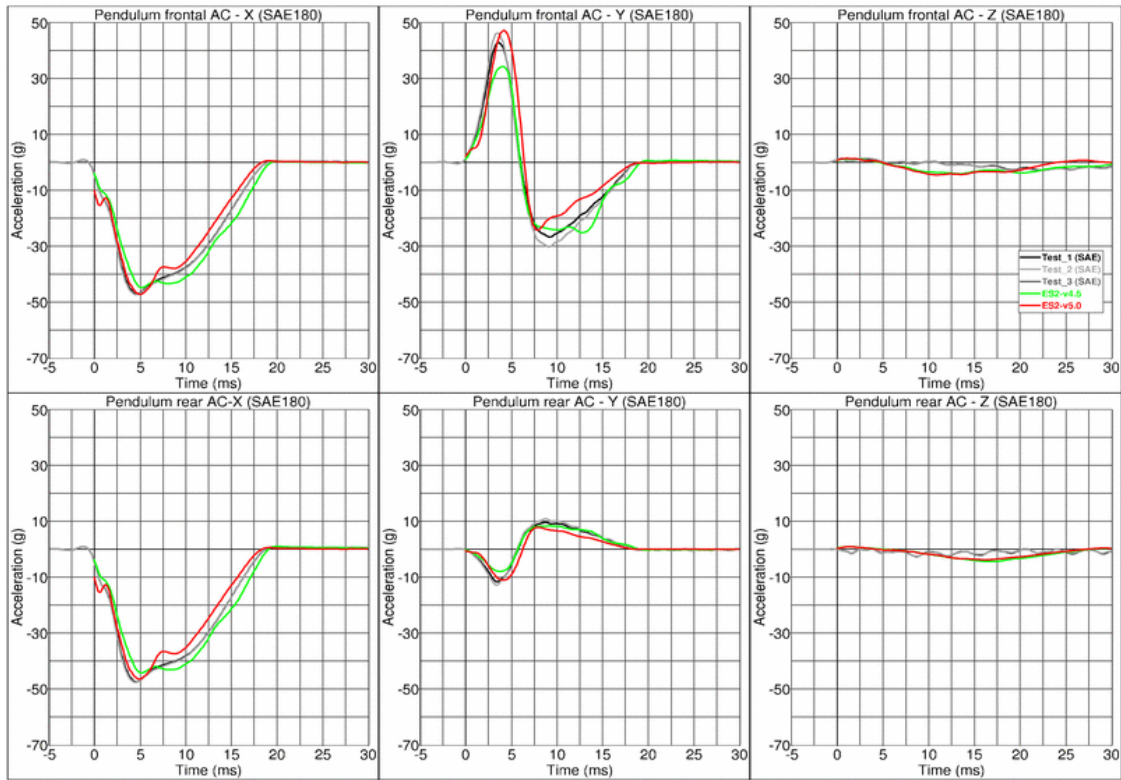

Clavicletest, y-Richtung, High velocity

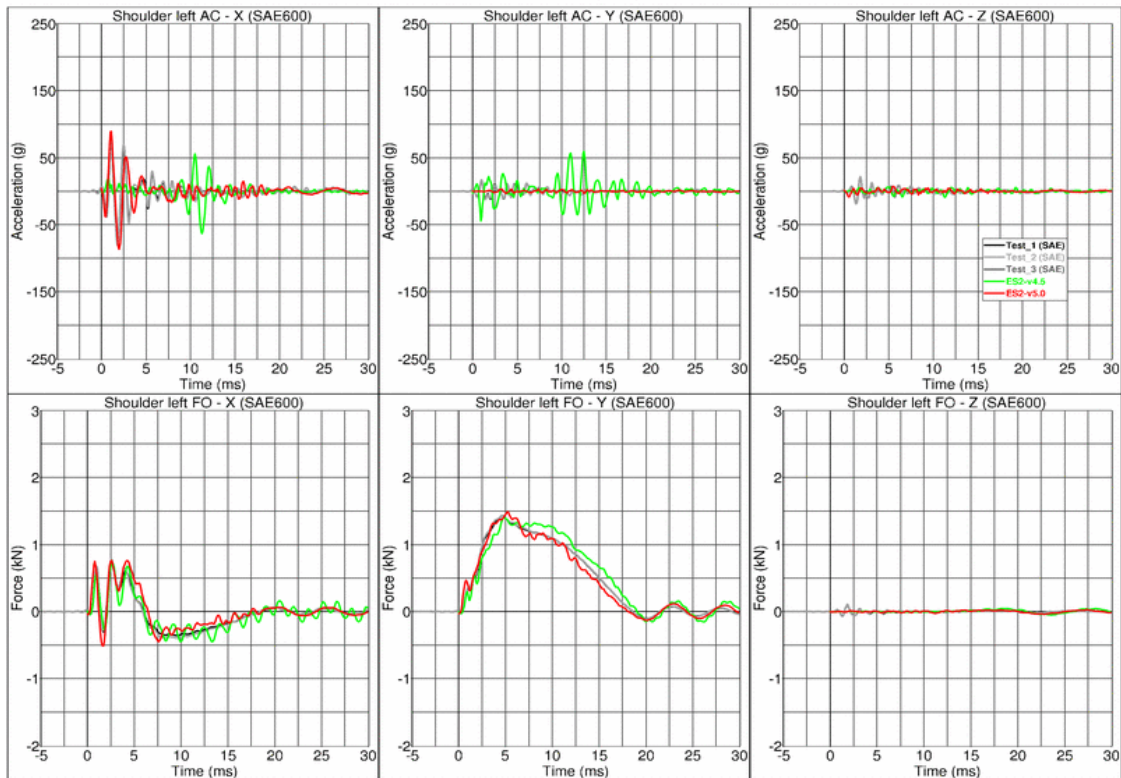

Results for Z-direction impact , low velocity

Clavicletest, z-Richtung, Low velocity

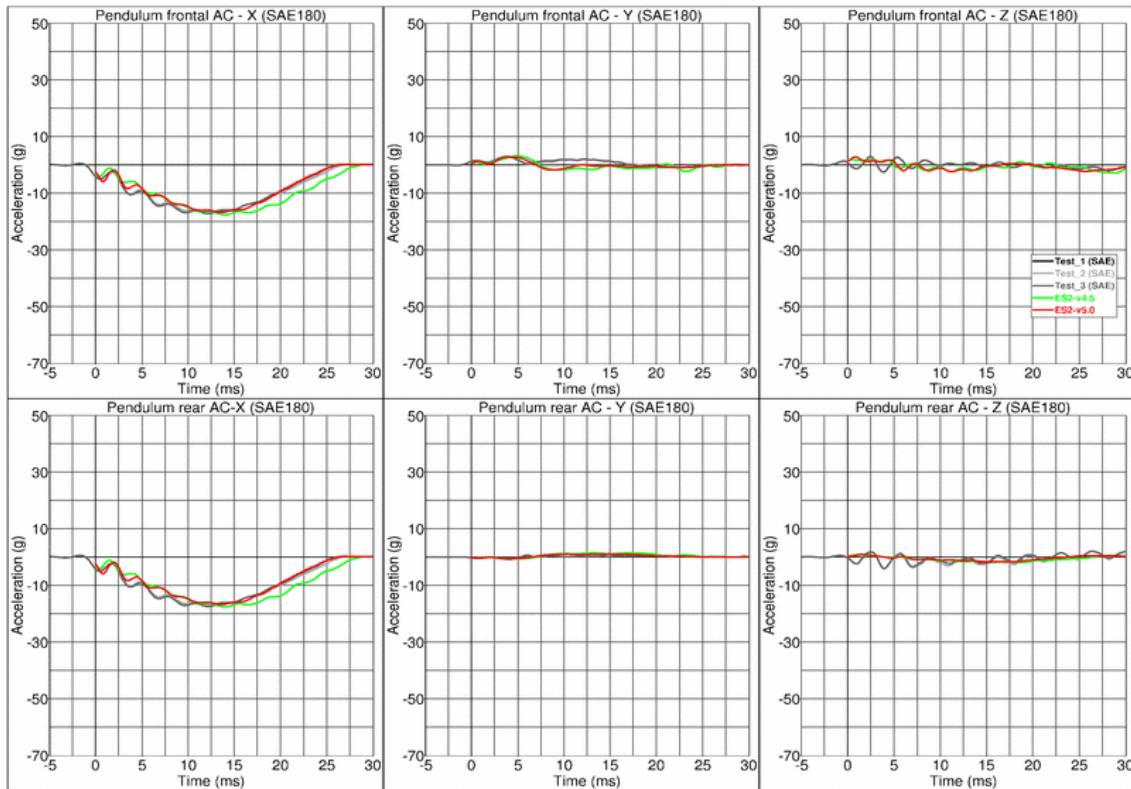

Clavicletest, z-Richtung, Low velocity

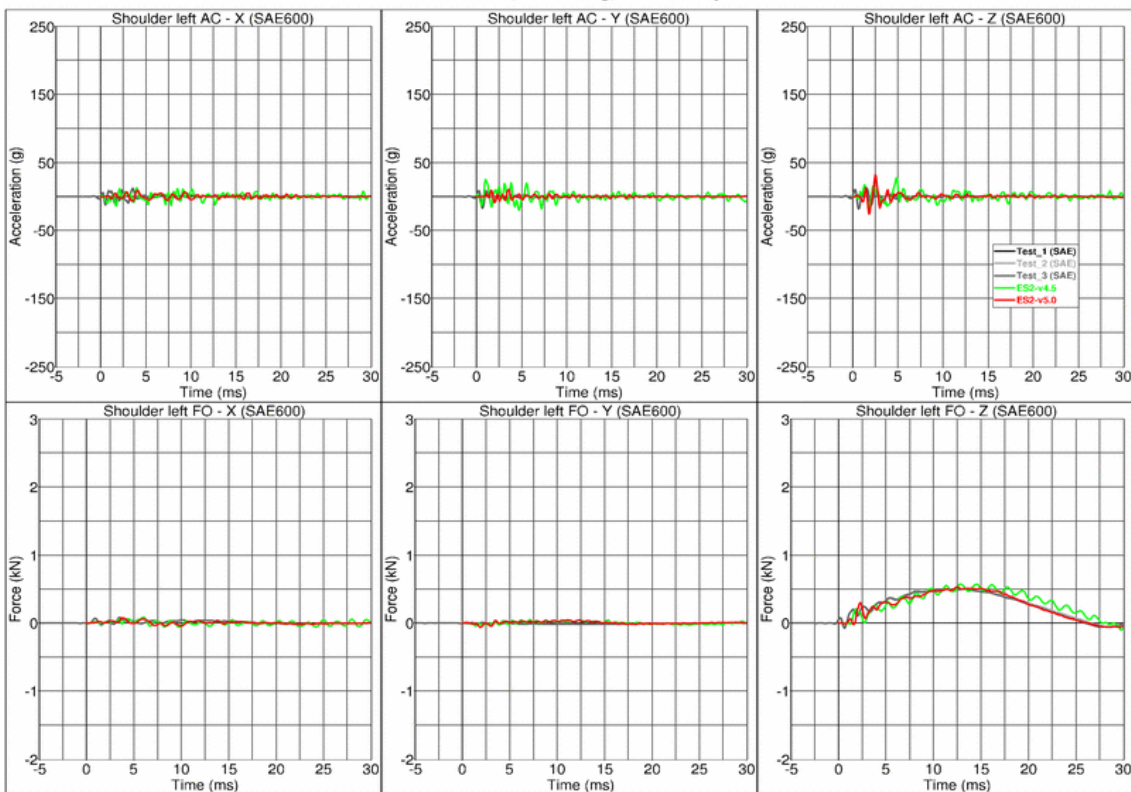

Results for Z-direction impact , high velocity

Clavicletest, z-Richtung, High velocity

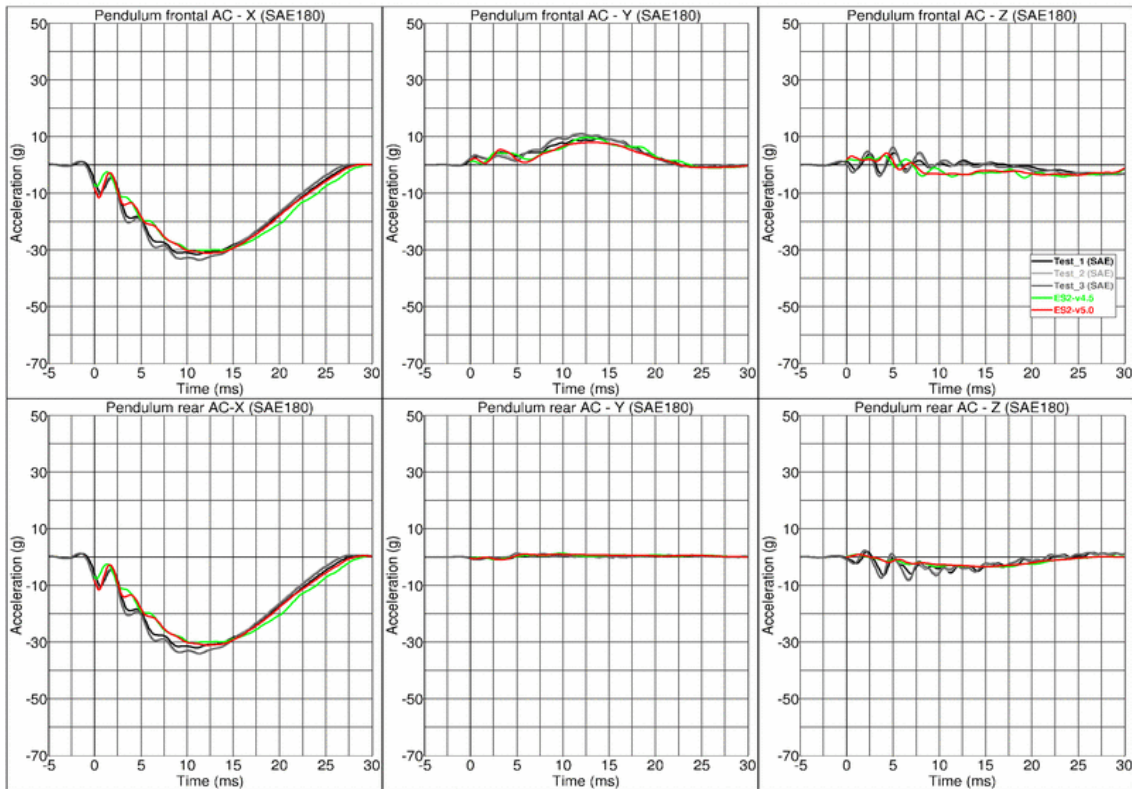

Clavicletest, z-Richtung, High velocity

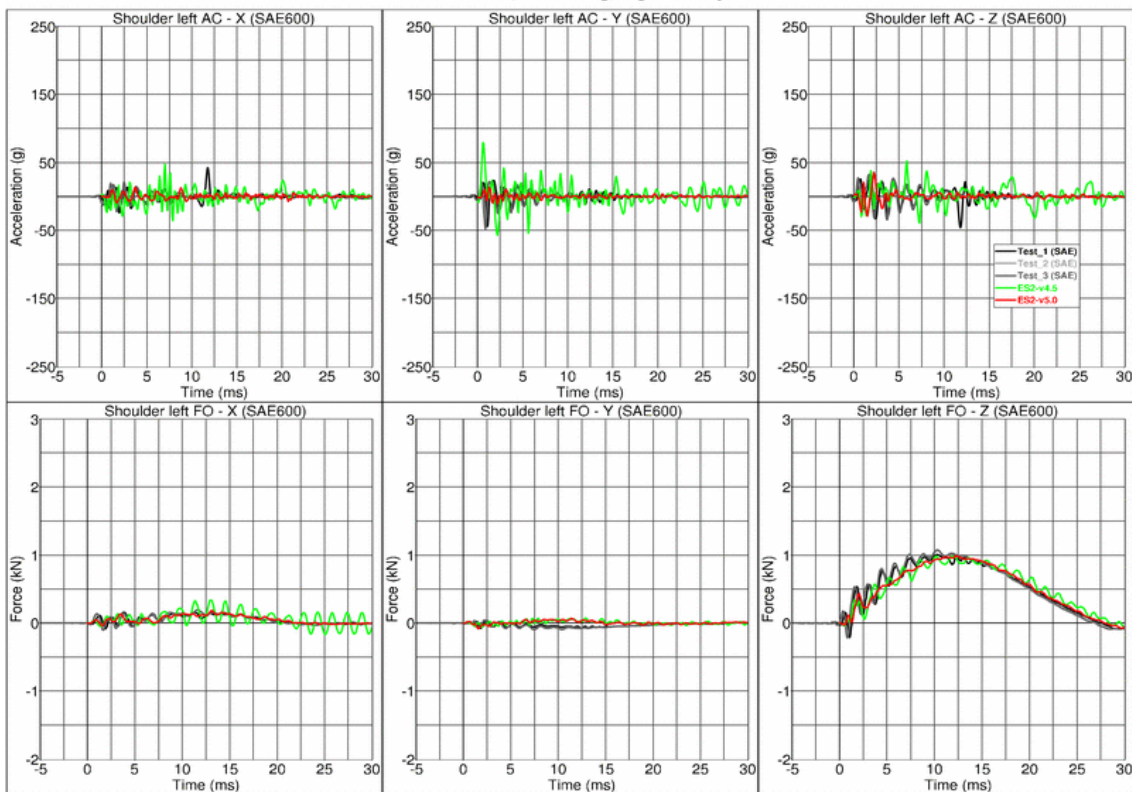

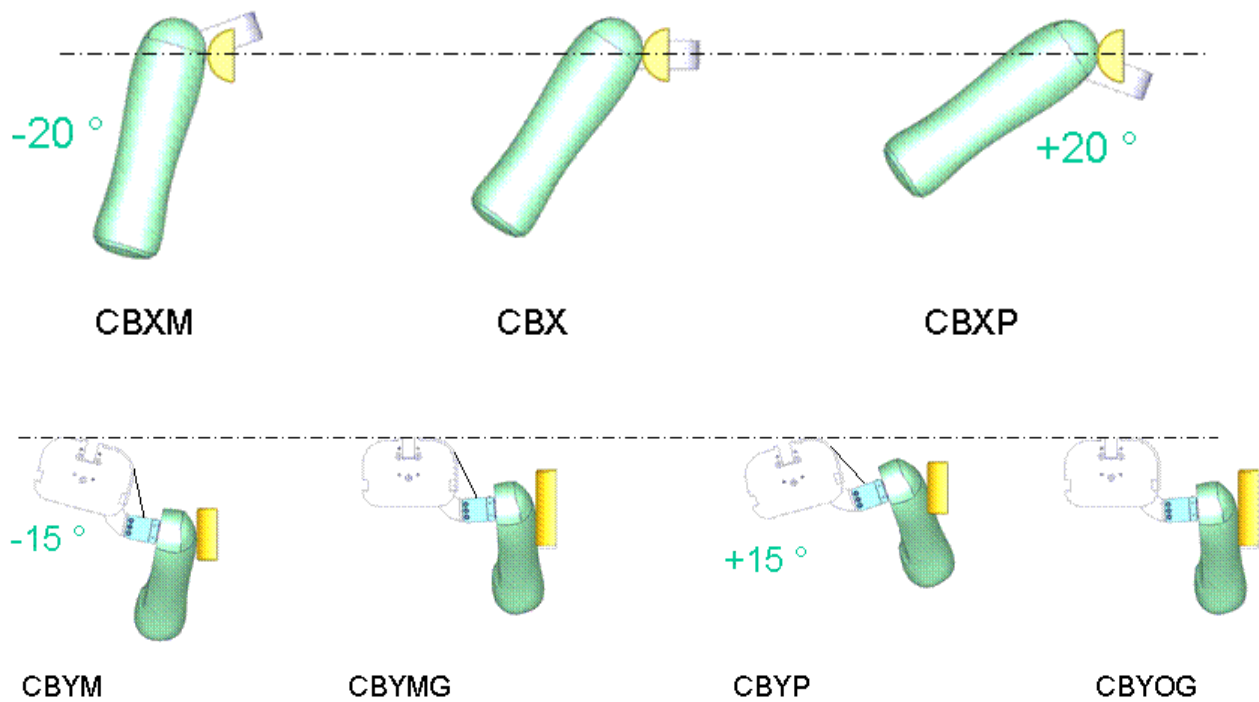
9.1.3 Clavicle Box test**Figure 27:** Test configurations for Clavicle Box test

The various test configurations for the clavicle box test are shown in the figure above. The pendulum impacts the arm and clavicle box assembly in x- and y-directions. For the impact in y-direction, tests are carried out with low and high velocities of the pendulum. An additional set of tests is carried out without the pre-stressed clavicle strap.

Results for X-direction impact, low velocity (CBX)

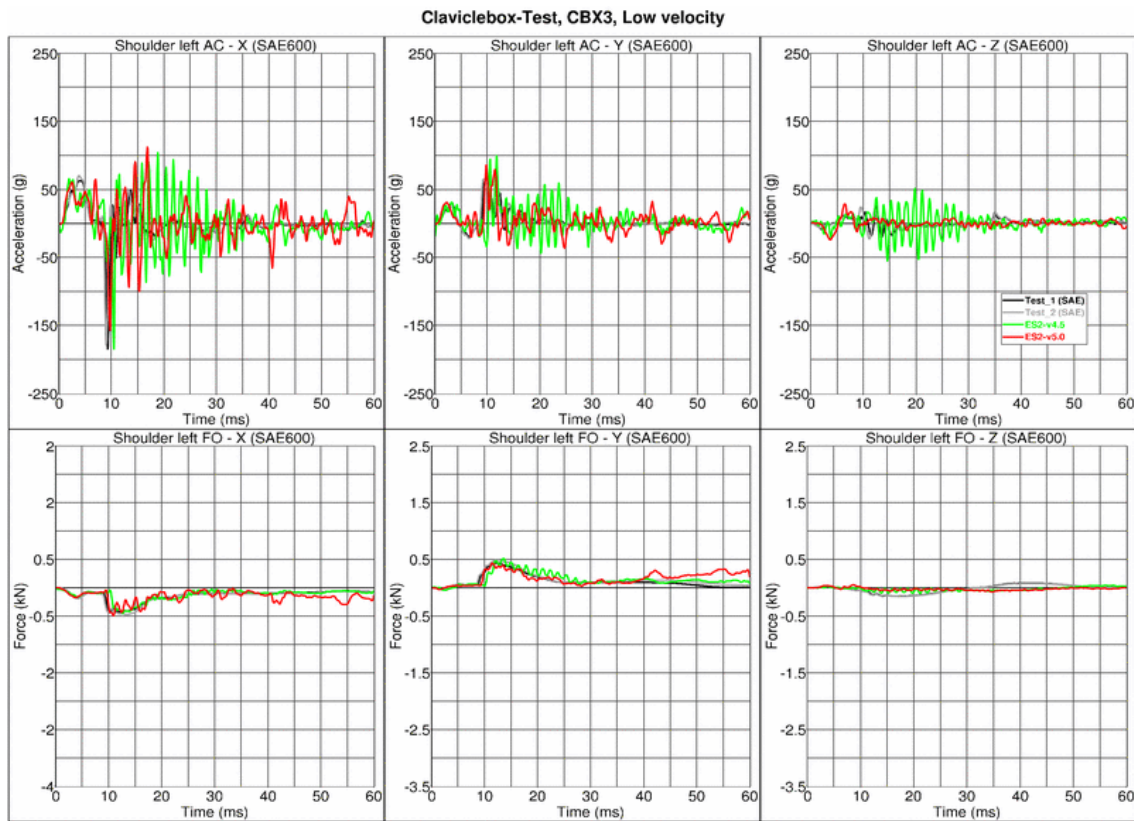
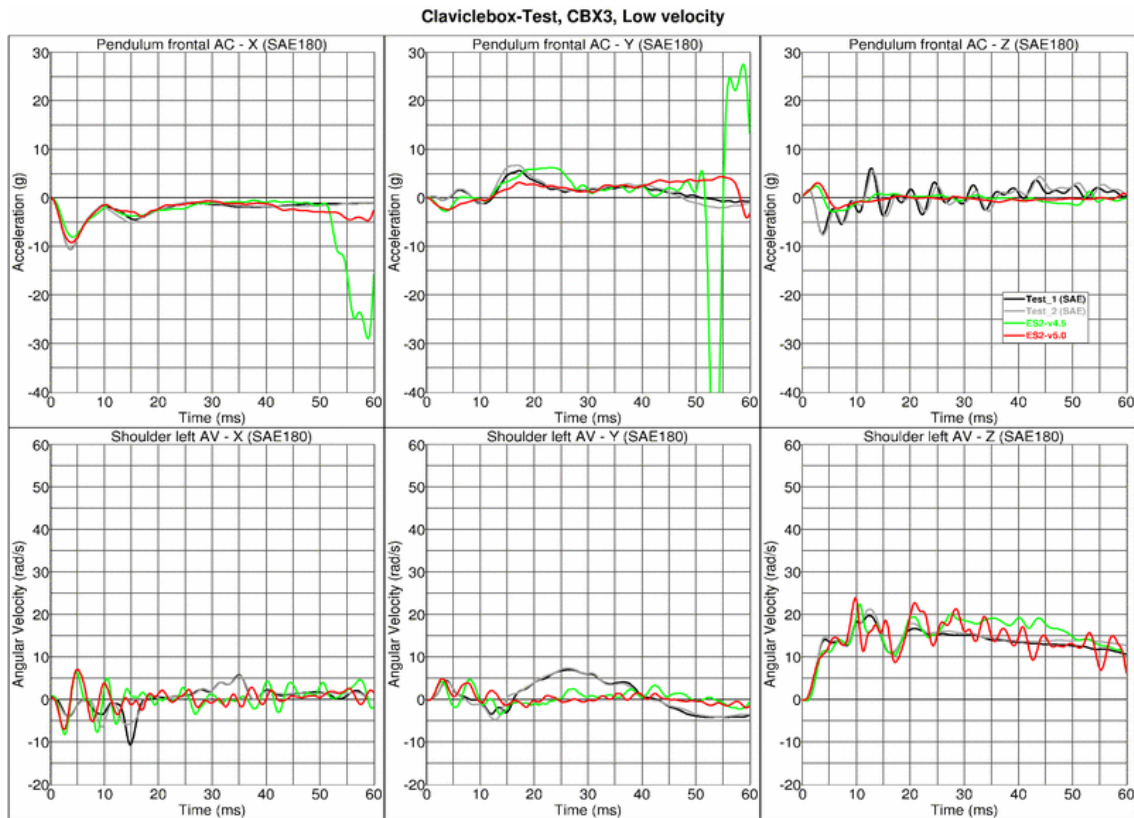

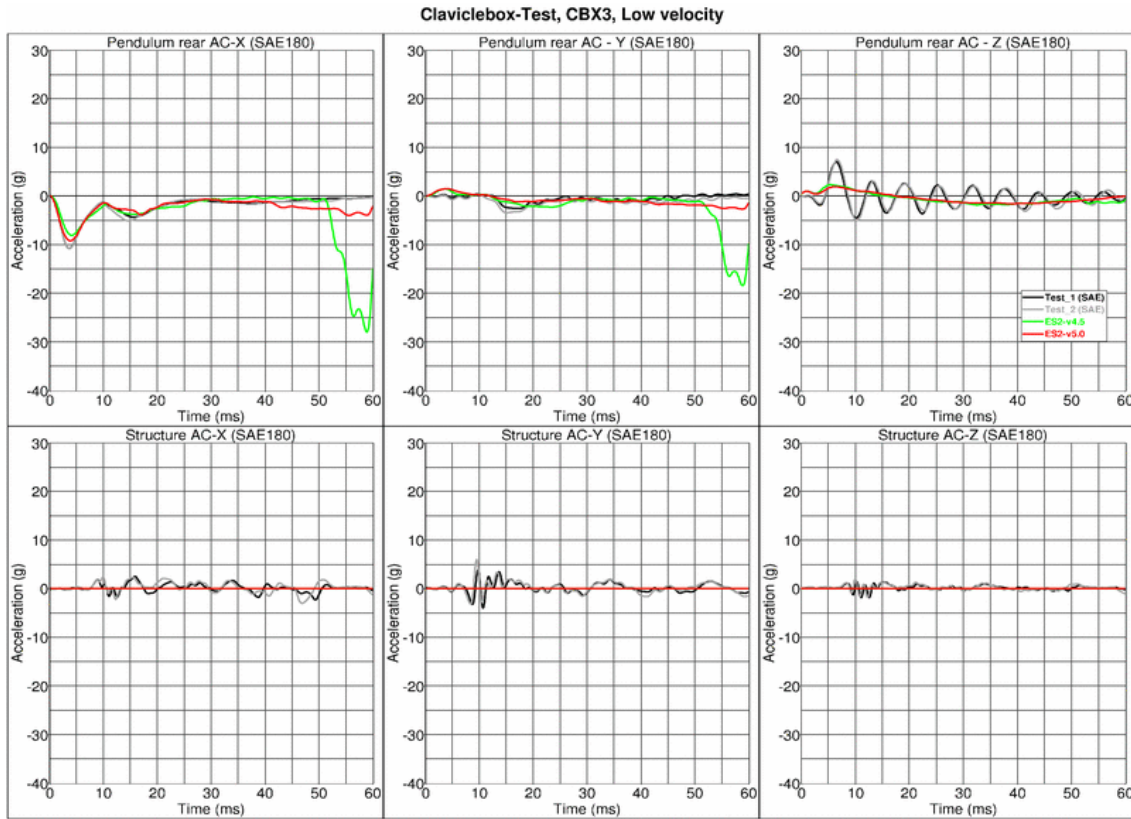

Results for X-direction impact, low velocity (CBXM)

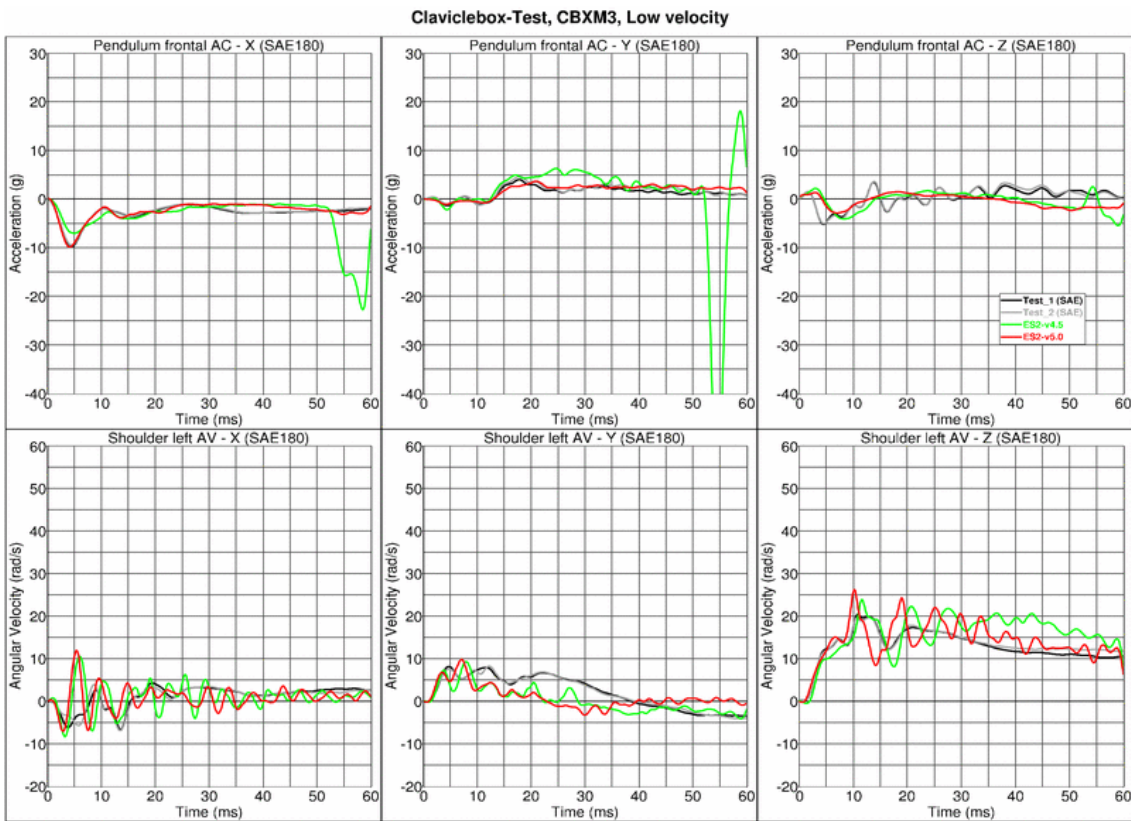

Claviclebox-Test, CBXM3, Low velocity

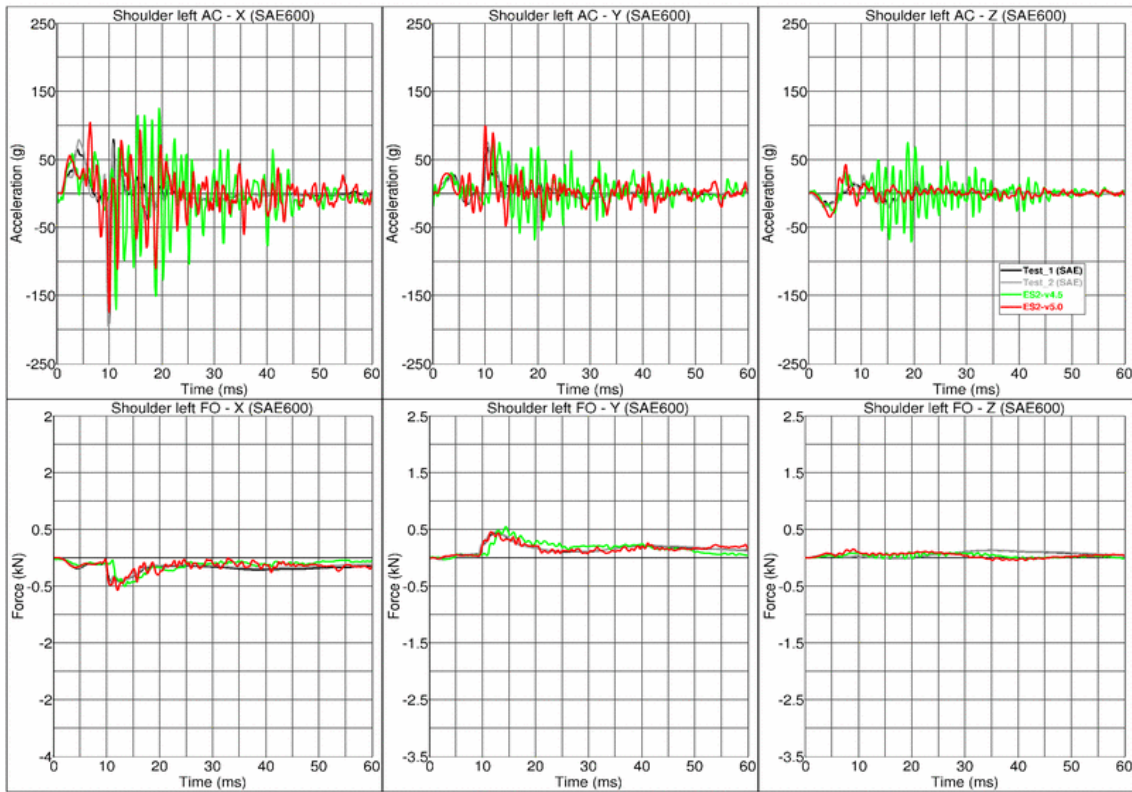

Claviclebox-Test, CBXM3, Low velocity

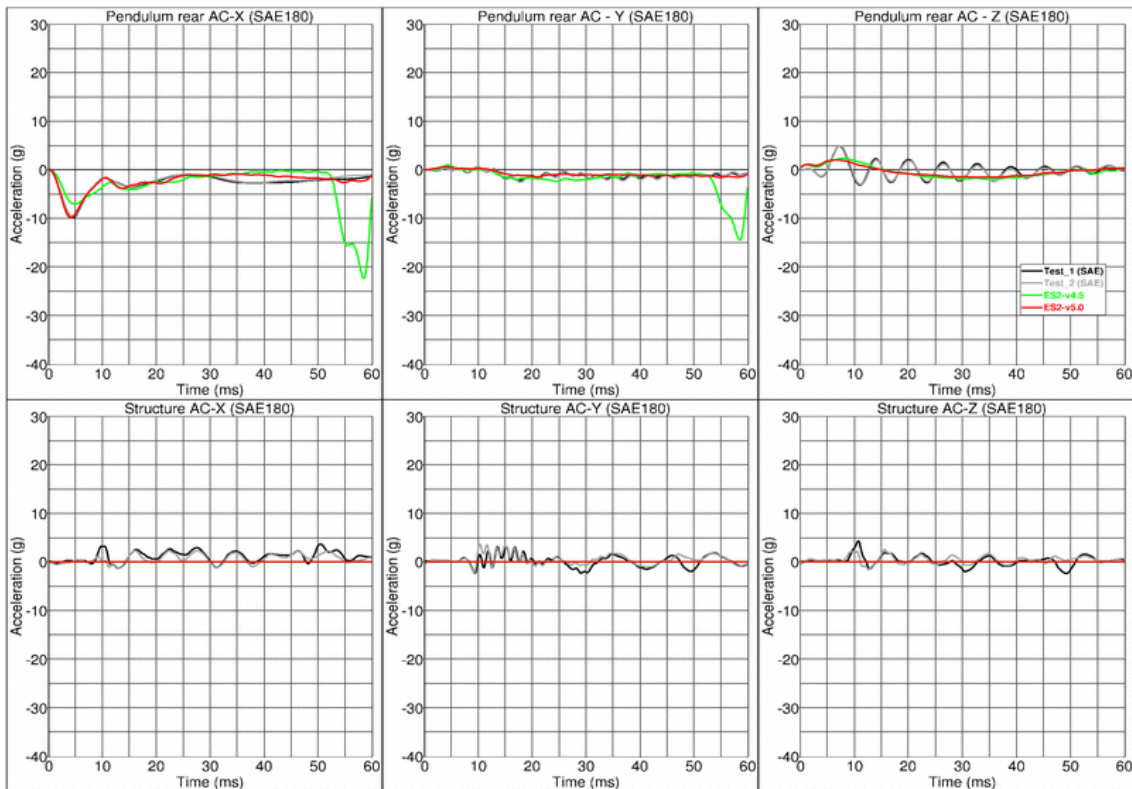

Results for X-direction impact, low velocity (CBXP)

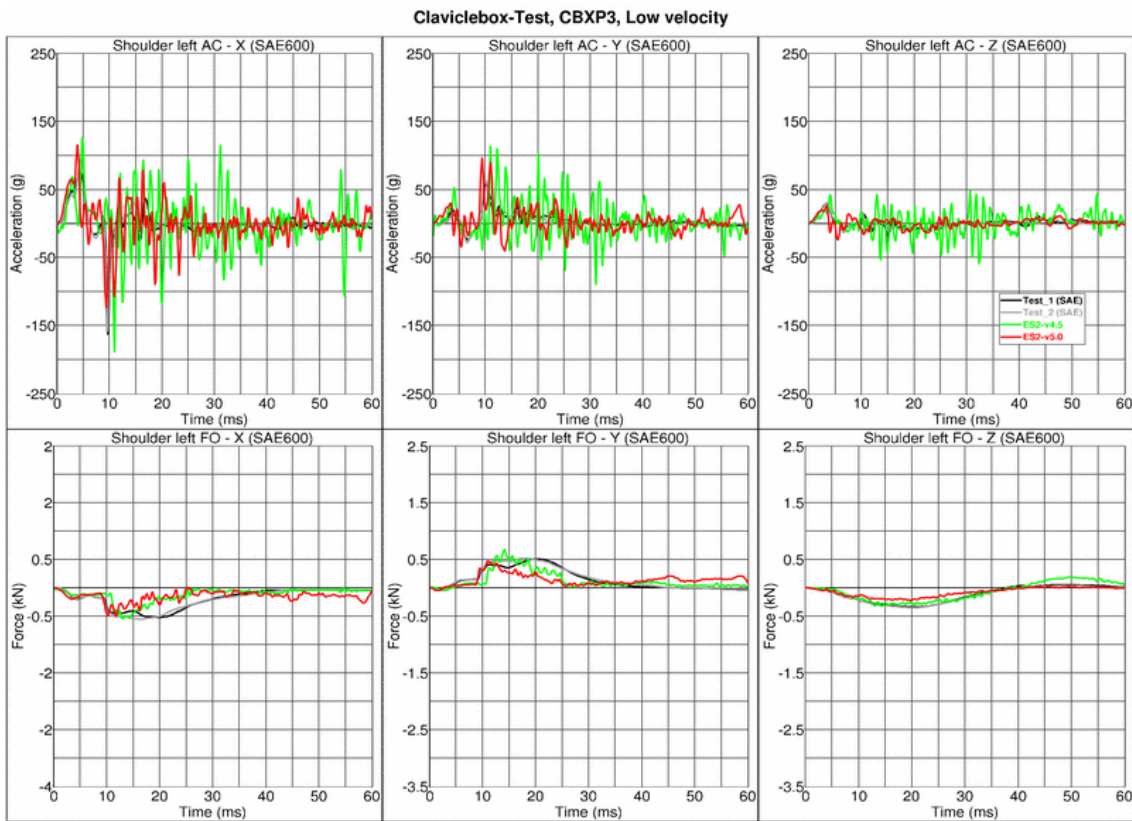
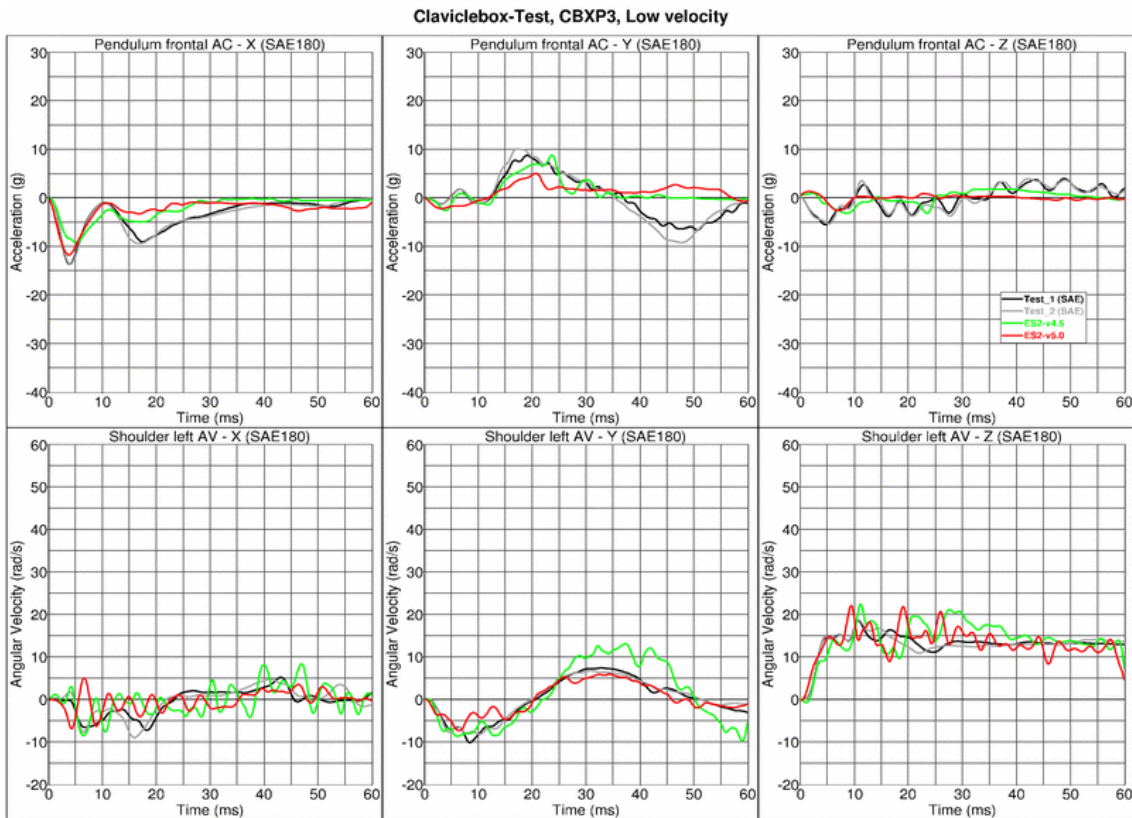

Claviclebox-Test, CBXP3, Low velocity

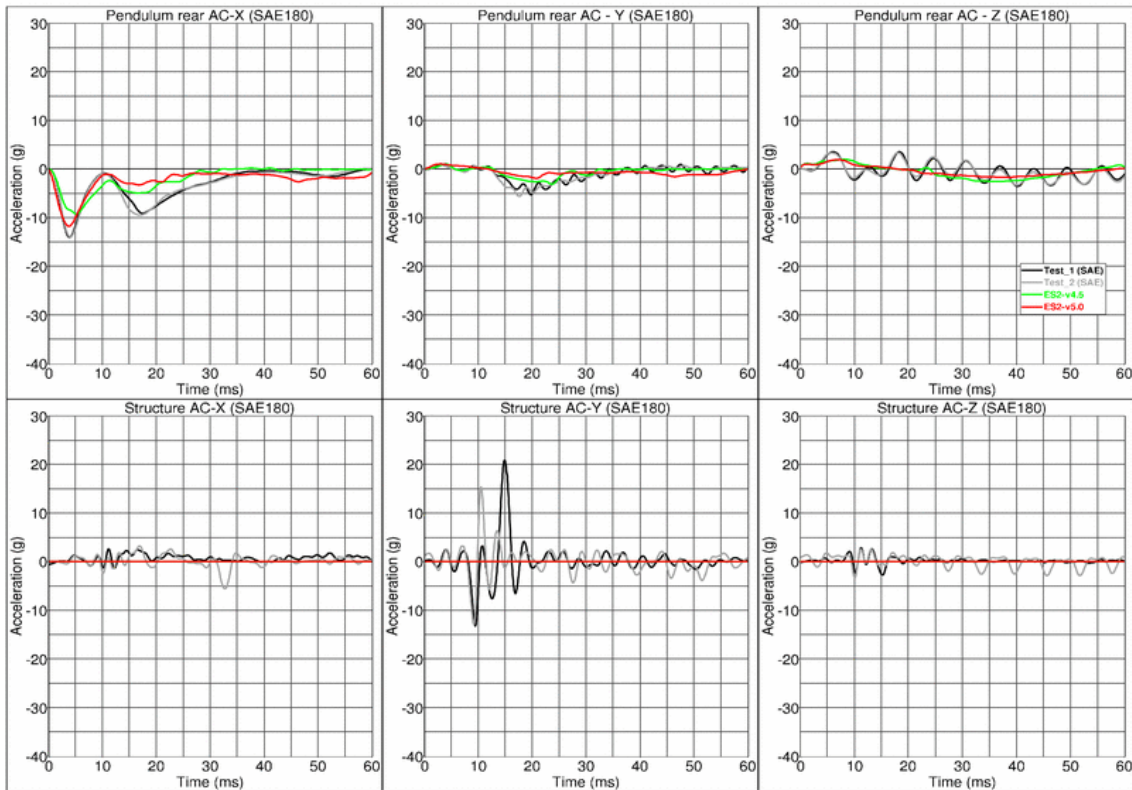

Results for Y-direction impact, low velocity (CBYM)

Claviclebox-Test, CBYM3, Low velocity

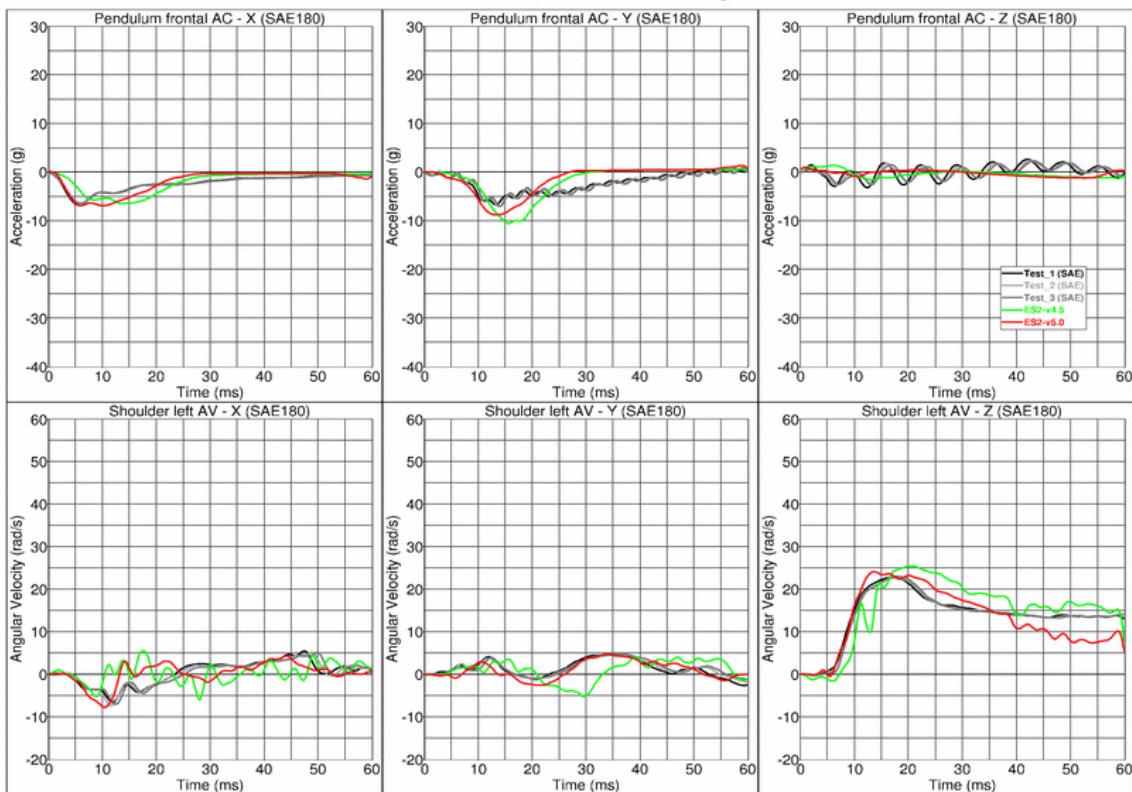

Claviclebox-Test, CBYM3, Low velocity

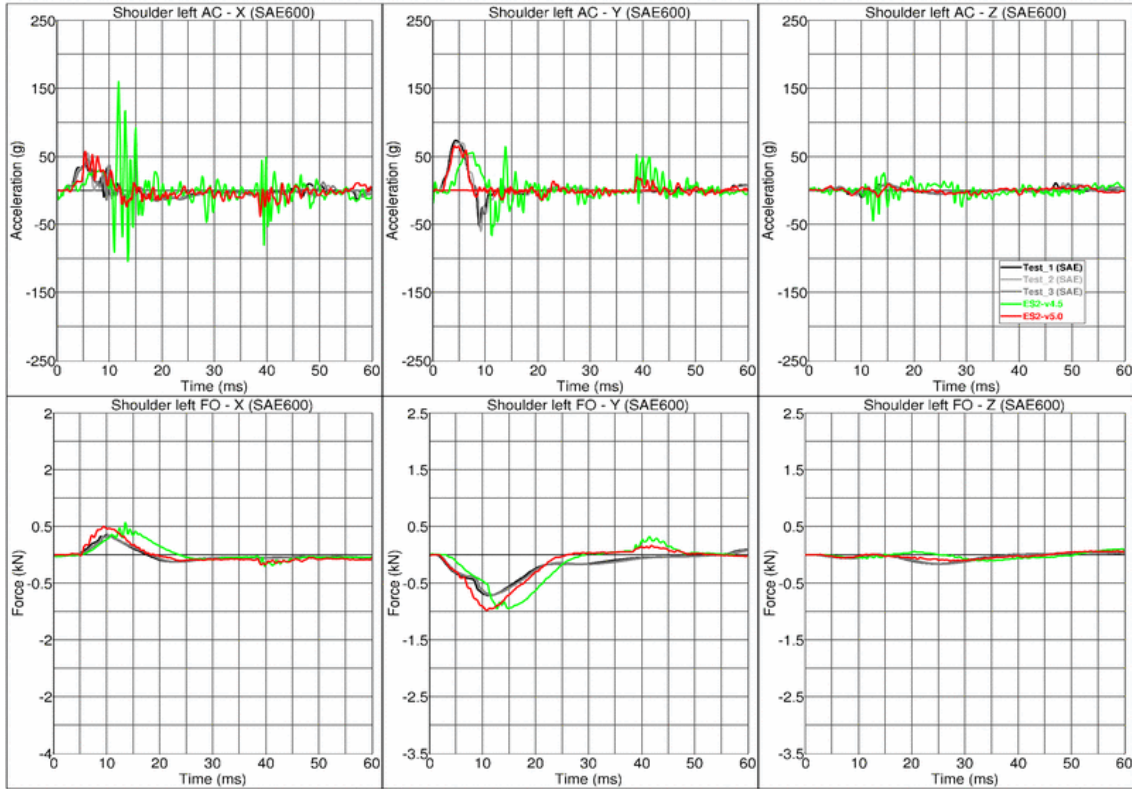

Claviclebox-Test, CBYM3, Low velocity

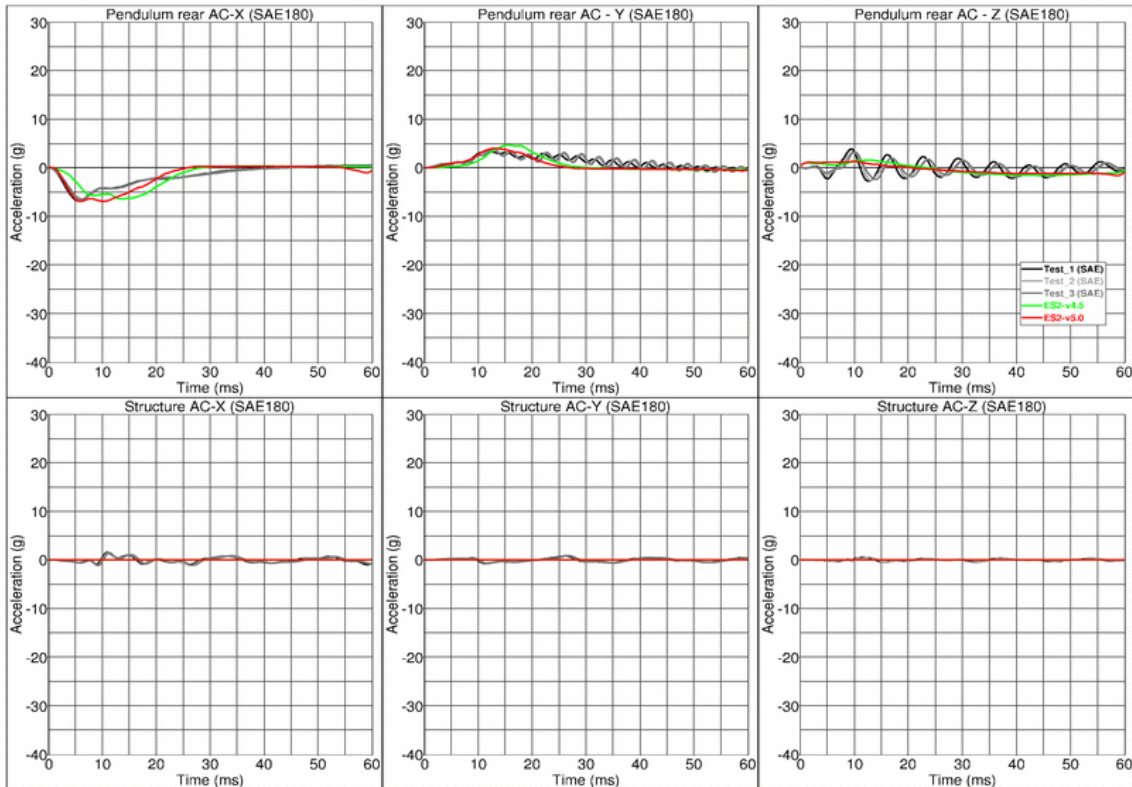

Results for Y-direction impact, high velocity (CBYM)

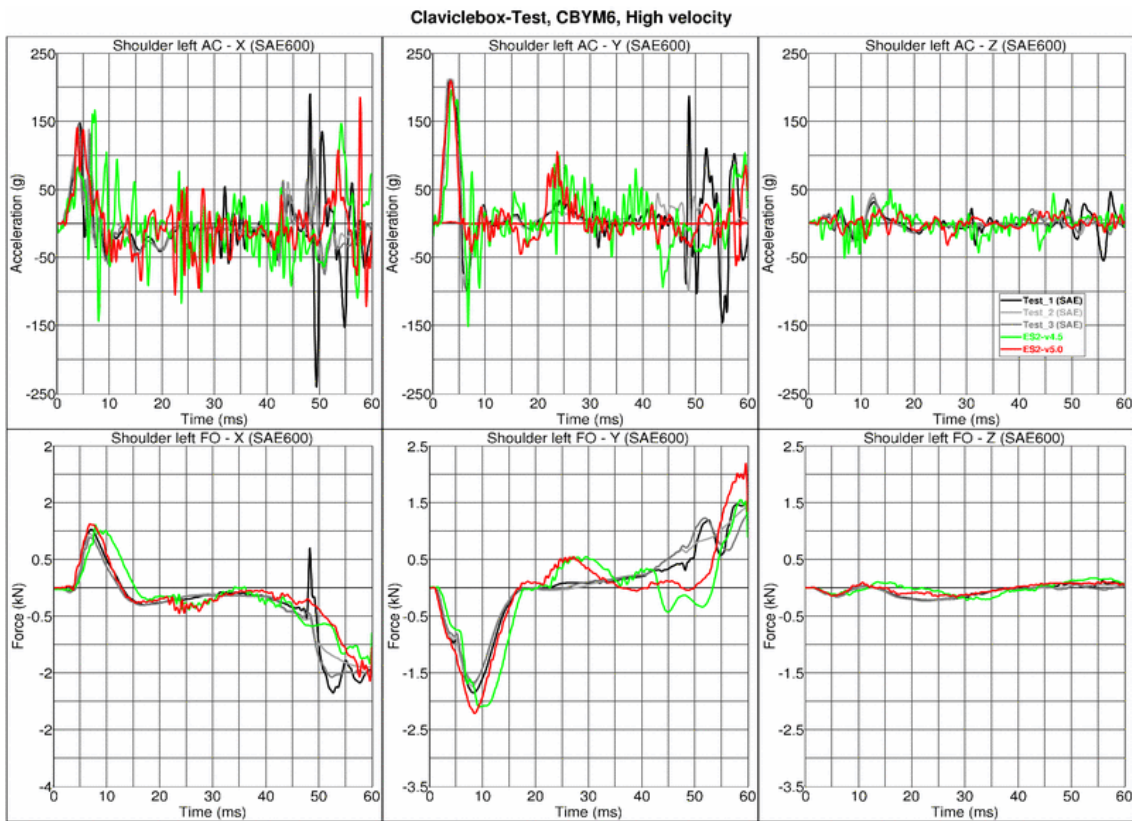
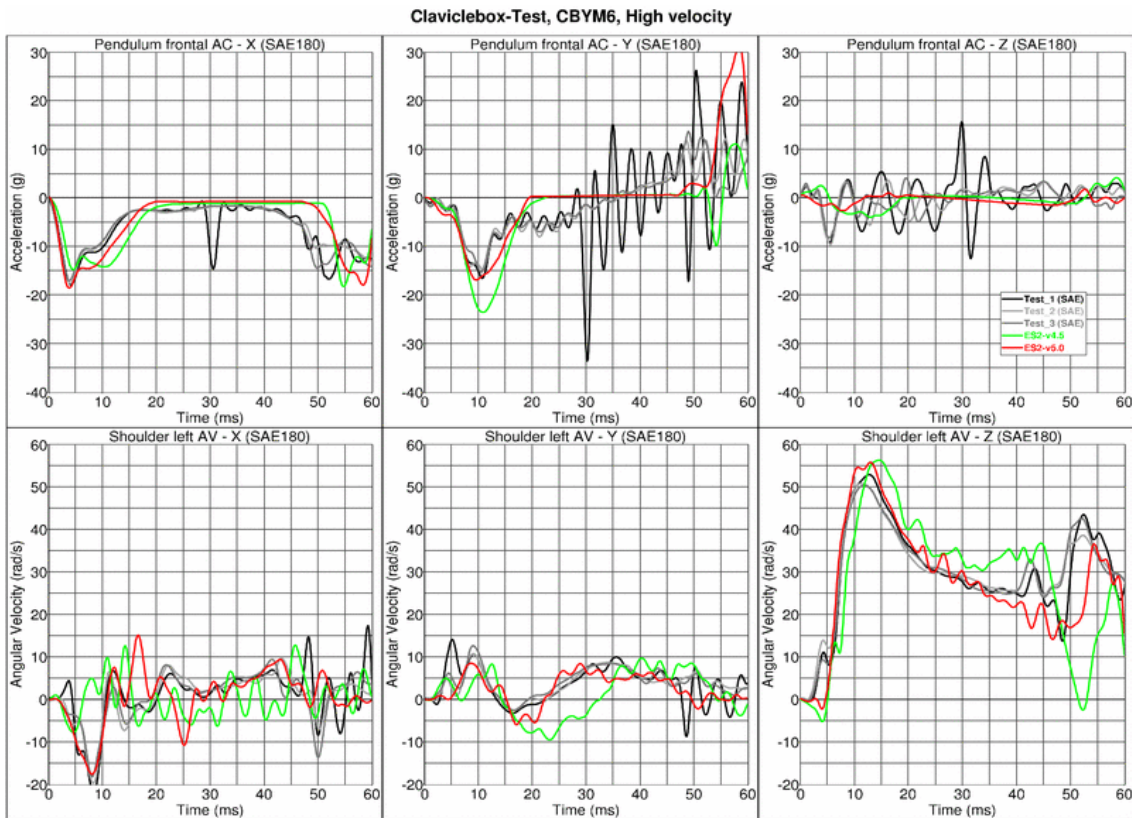

Claviclebox-Test, CBYM6, High velocity

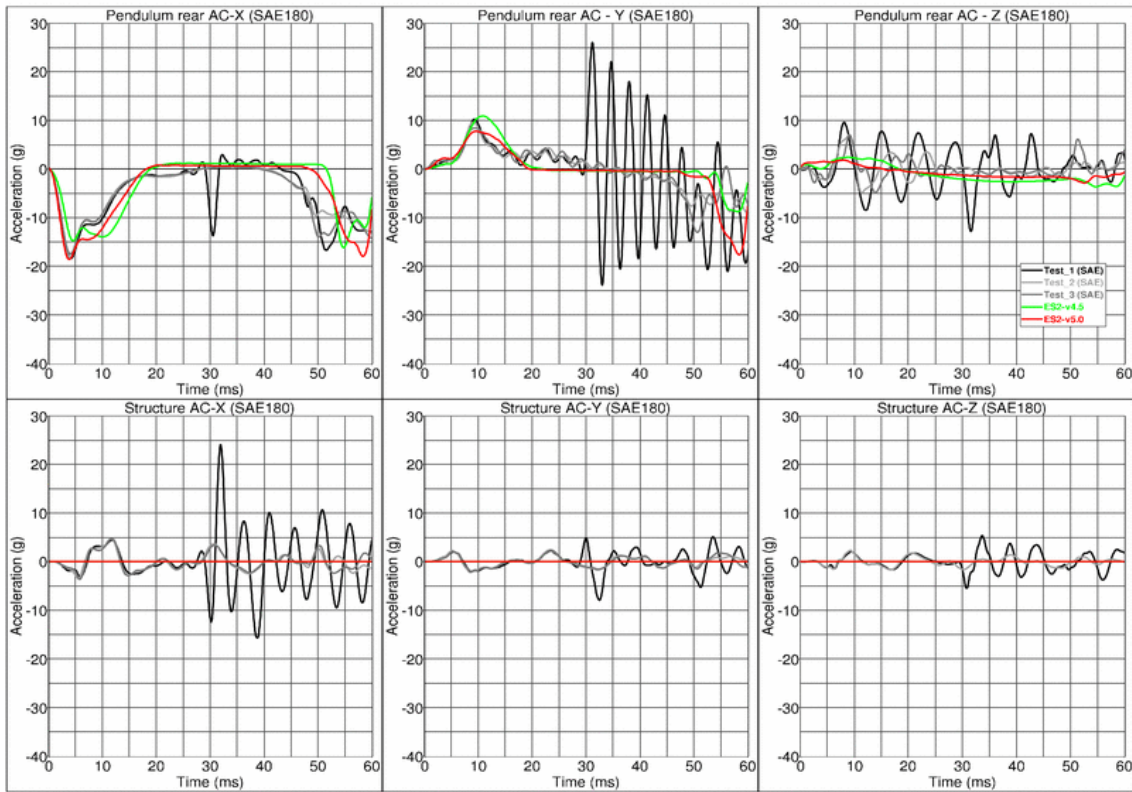

Results for Y-direction impact, low velocity (CBYP)

Claviclebox-Test, CBYP3, Low velocity

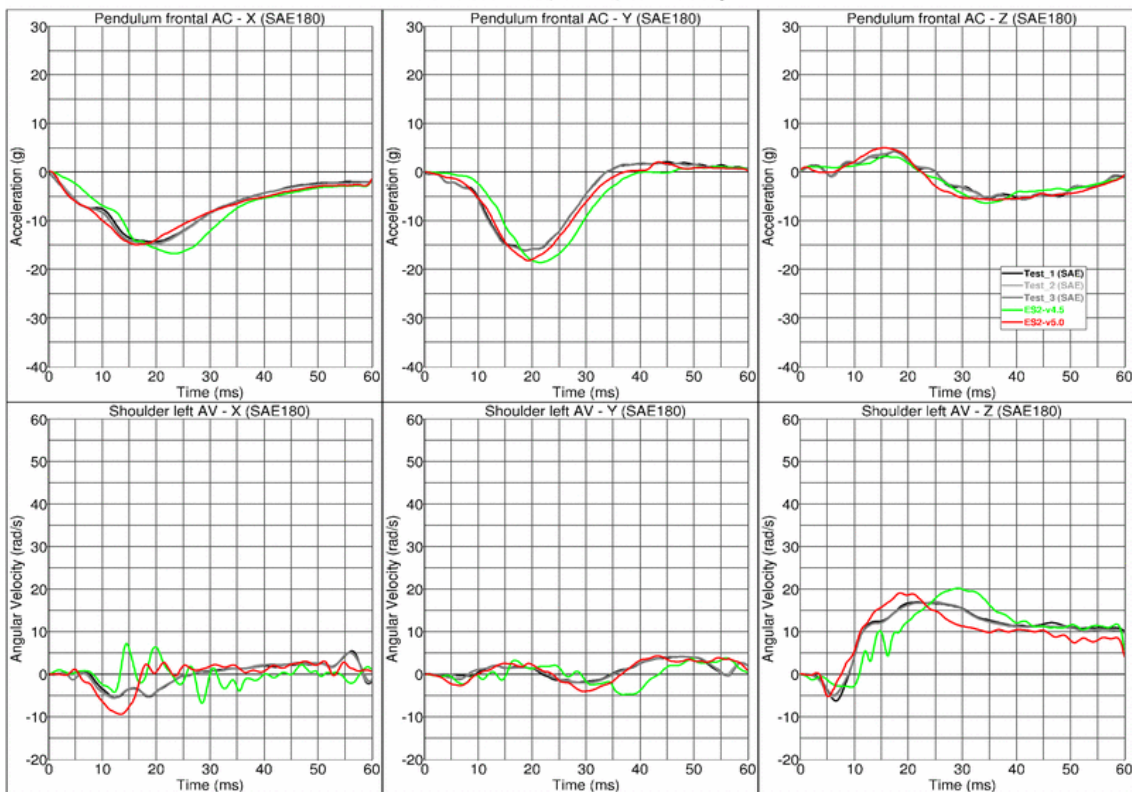

Claviclebox-Test, CBYP3, Low velocity

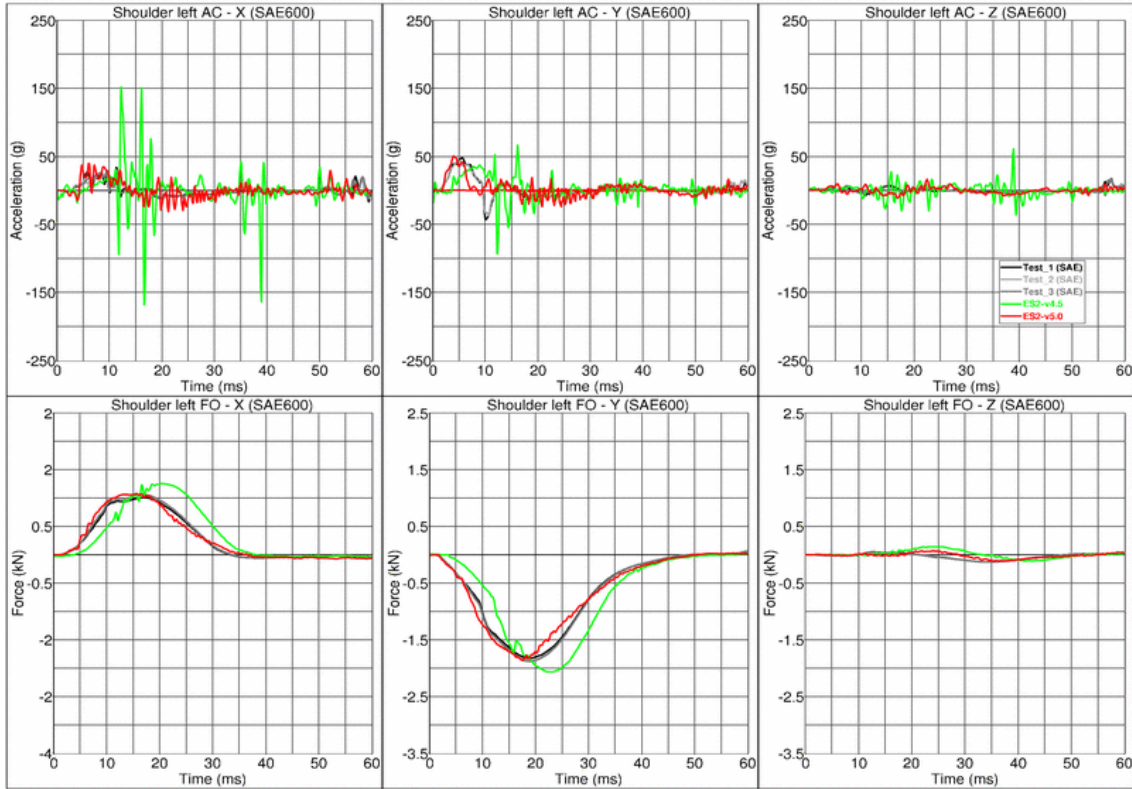

Claviclebox-Test, CBYP3, Low velocity

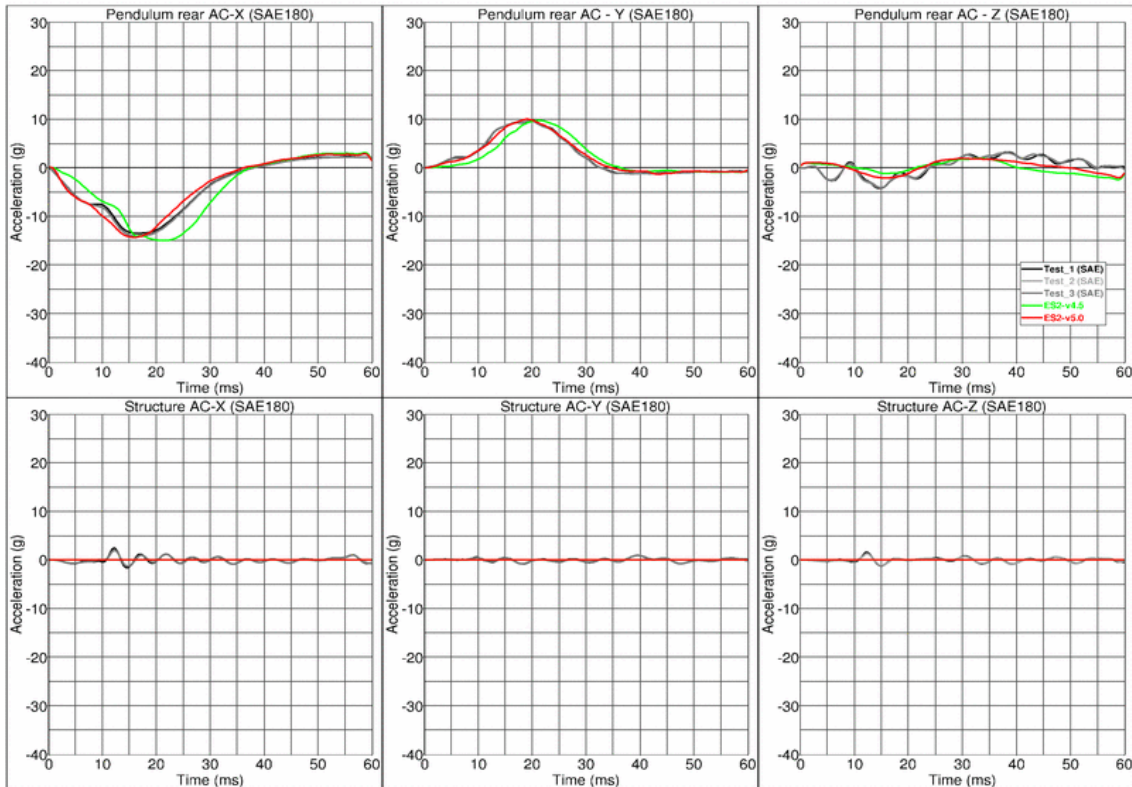

Results for Y-direction impact, high velocity (CBYP)

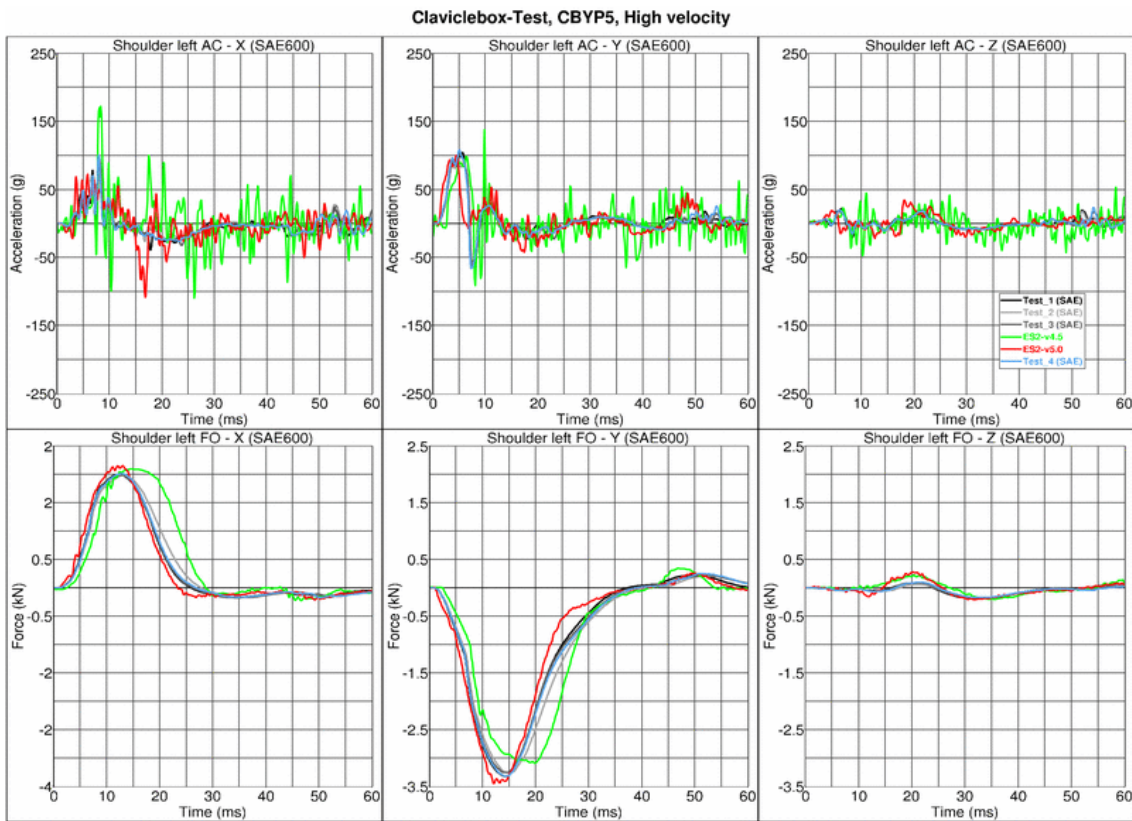
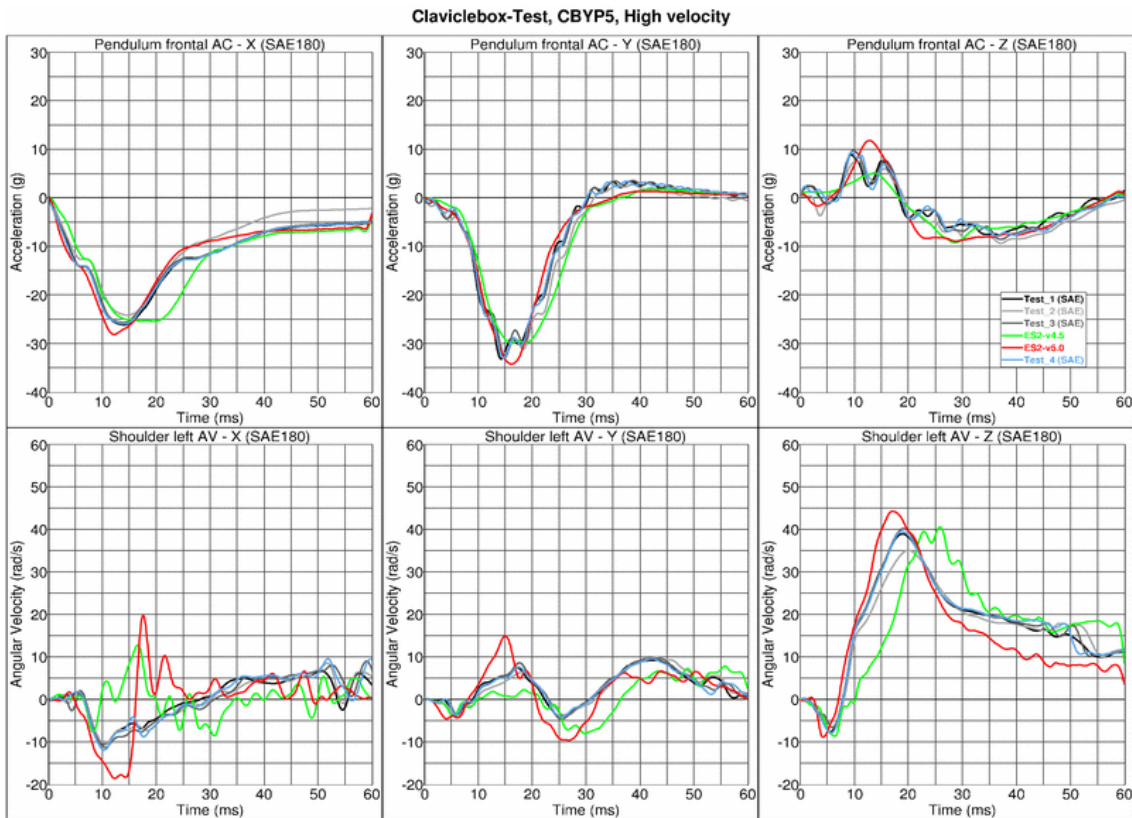

Claviclebox-Test, CBYP5, High velocity

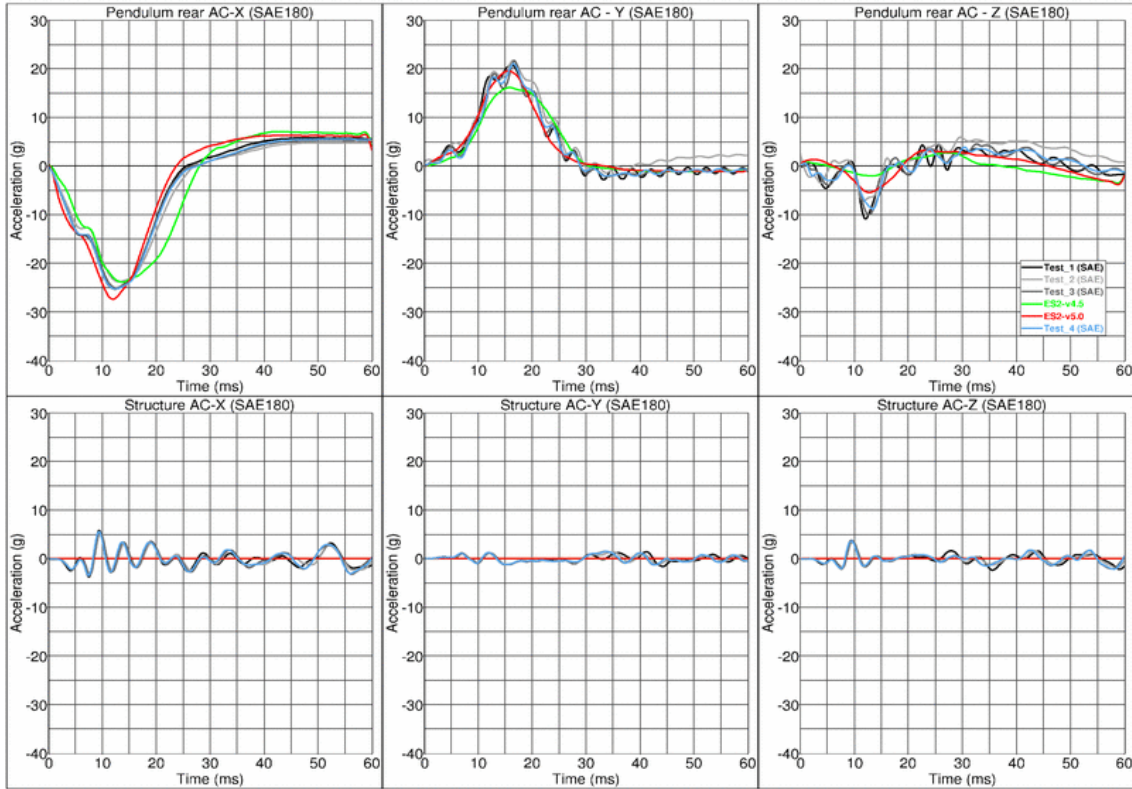

Results for Y-direction impact, low velocity, with clavicle strap (CBYMG)

Claviclebox-Test, CBY3MG, Low velocity

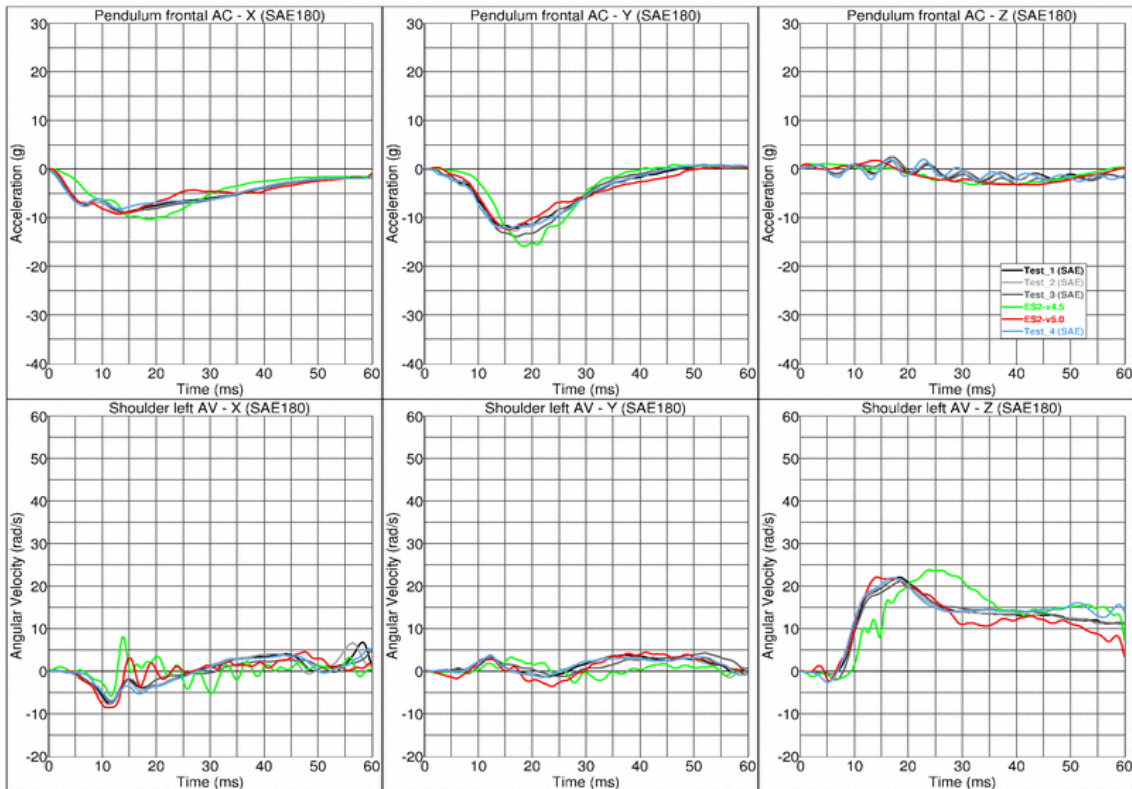

Claviclebox-Test, CBY3MG, Low velocity

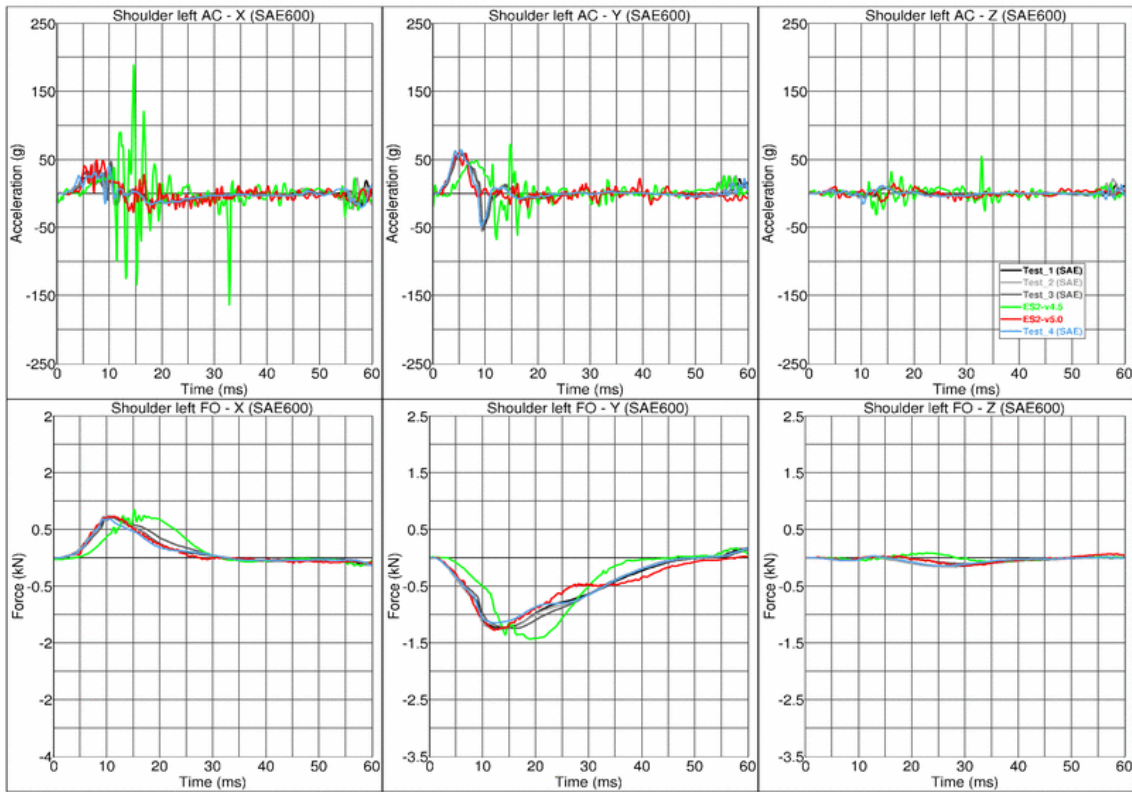

Claviclebox-Test, CBY3MG, Low velocity

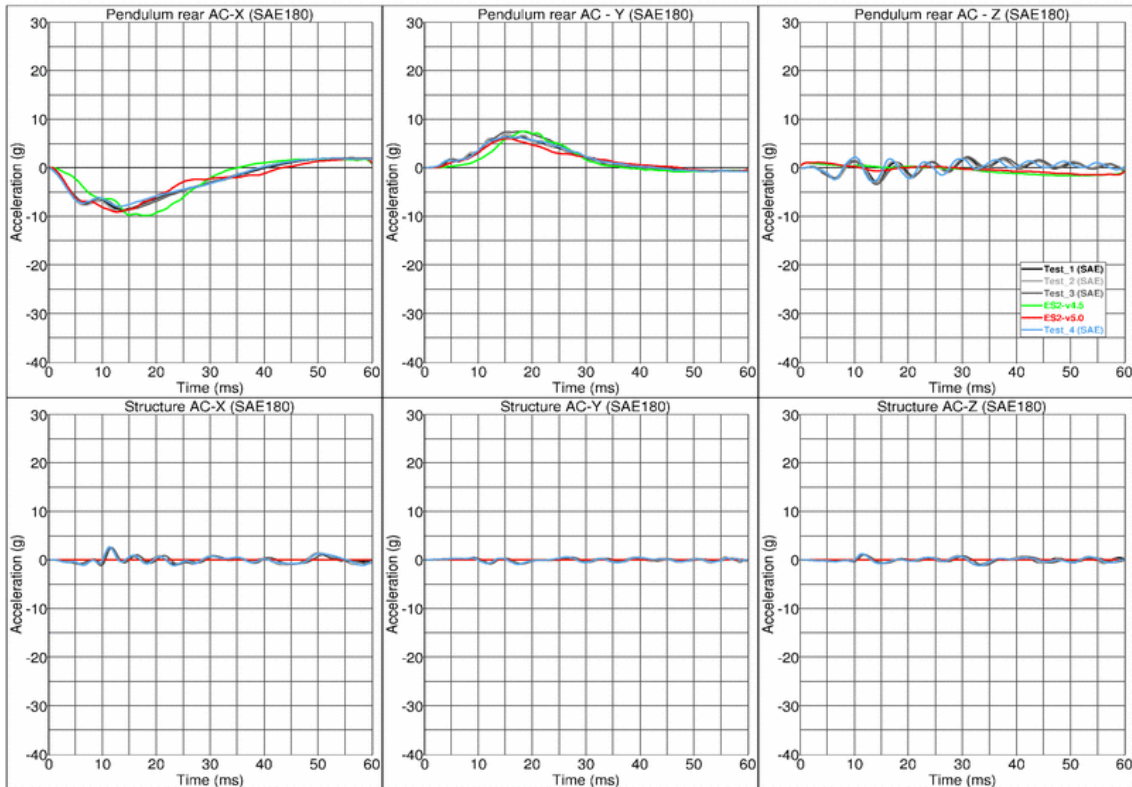

Results for Y-direction impact, high velocity, with clavicle strap (CBYMG)

Claviclebox-Test, CBY6MG, High velocity

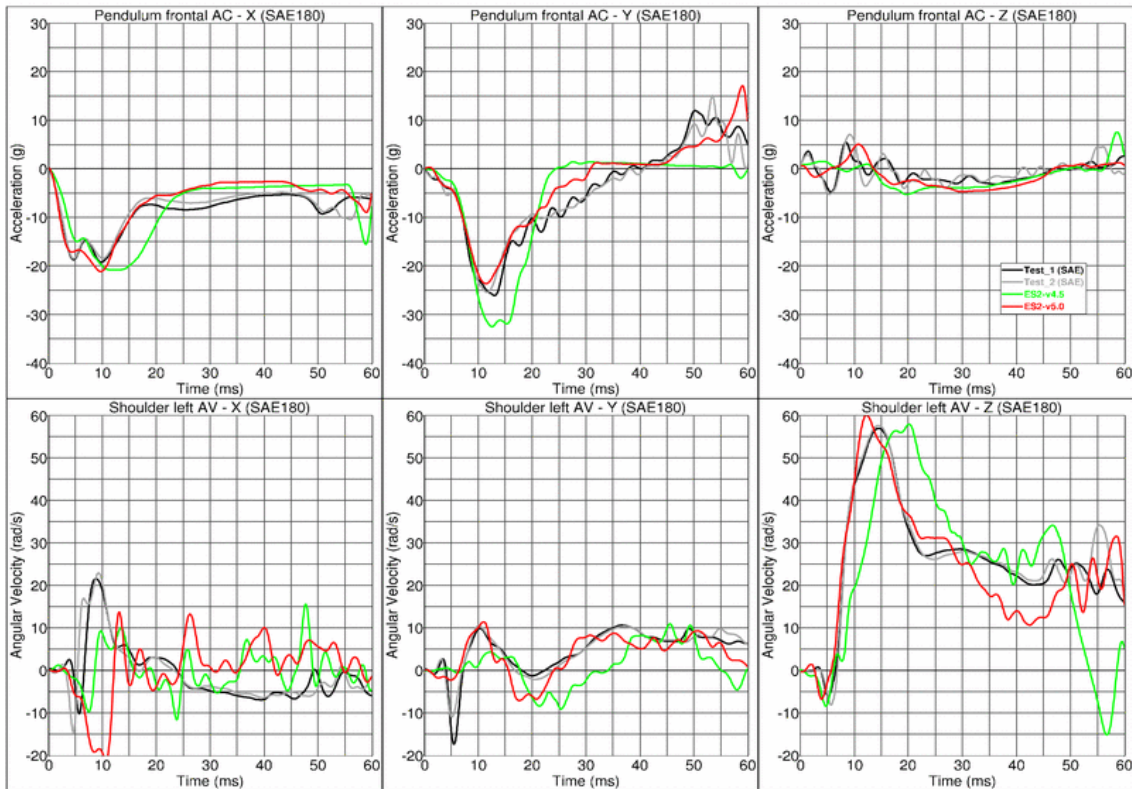

Claviclebox-Test, CBY6MG, High velocity

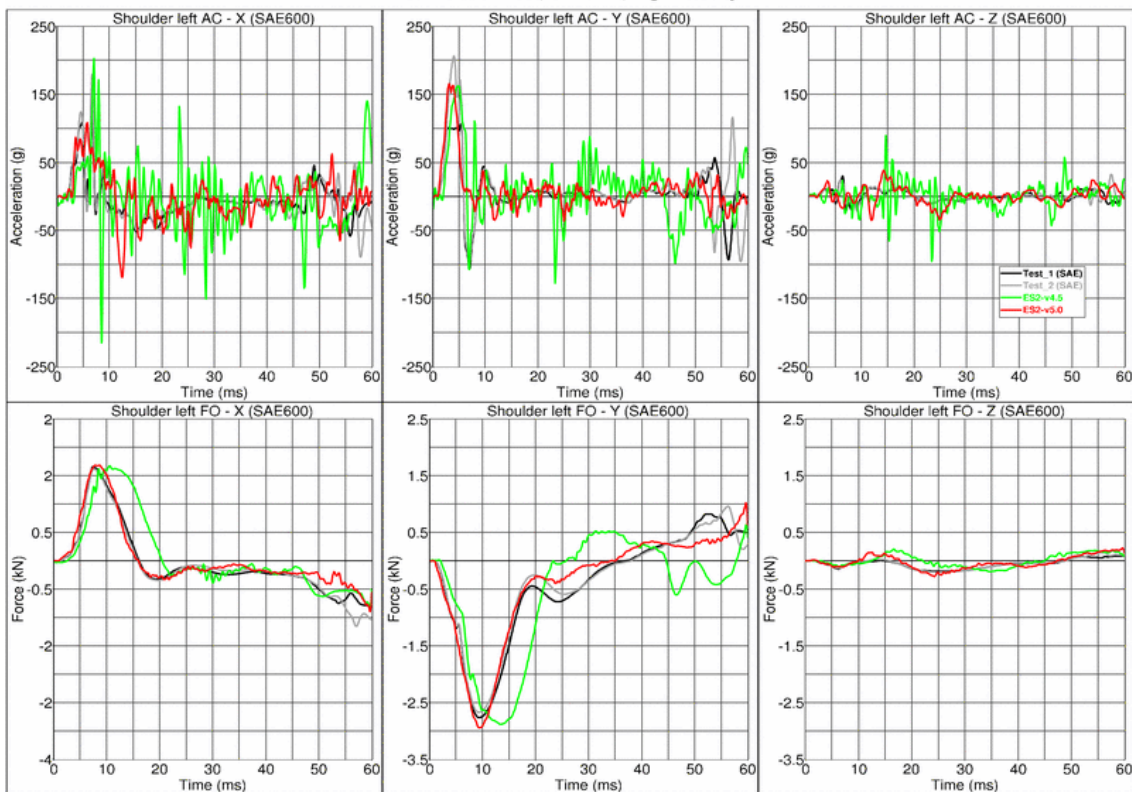

Claviclebox-Test, CBY6MG, High velocity

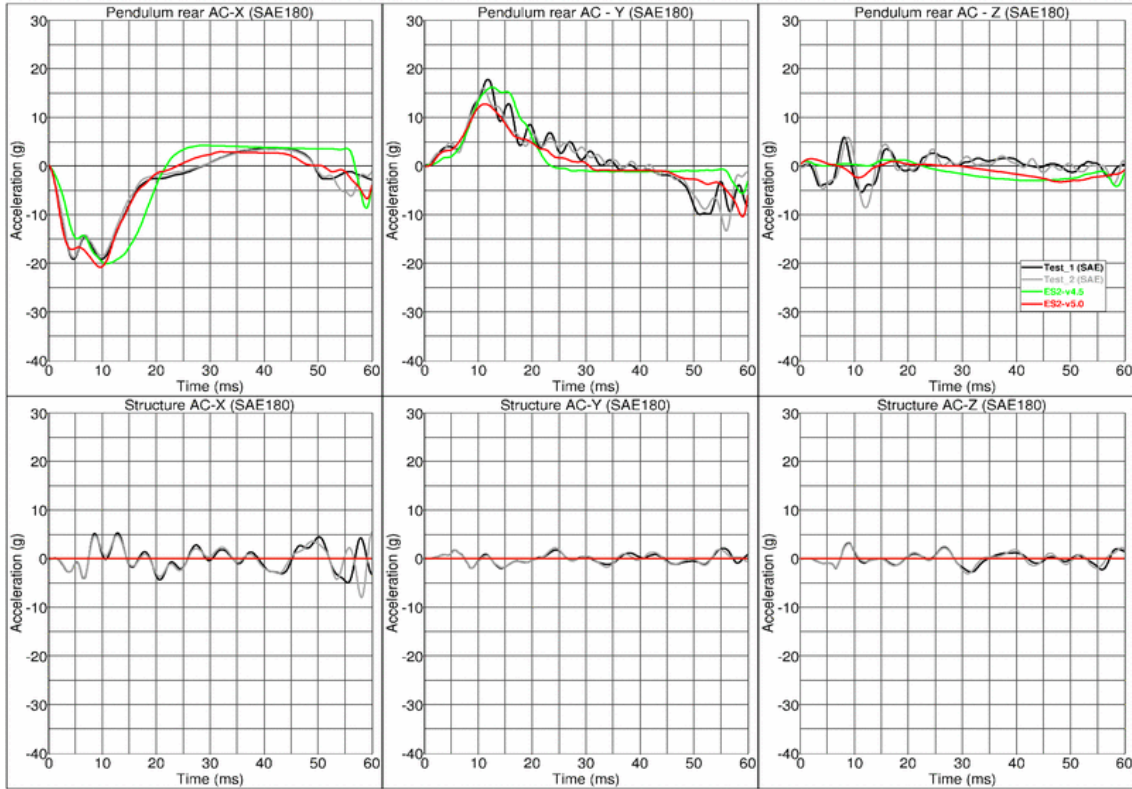

Results for Y-direction impact, low velocity, w/o clavicle strap (CBYOG)

Claviclebox-Test, CBY3OG, Low velocity

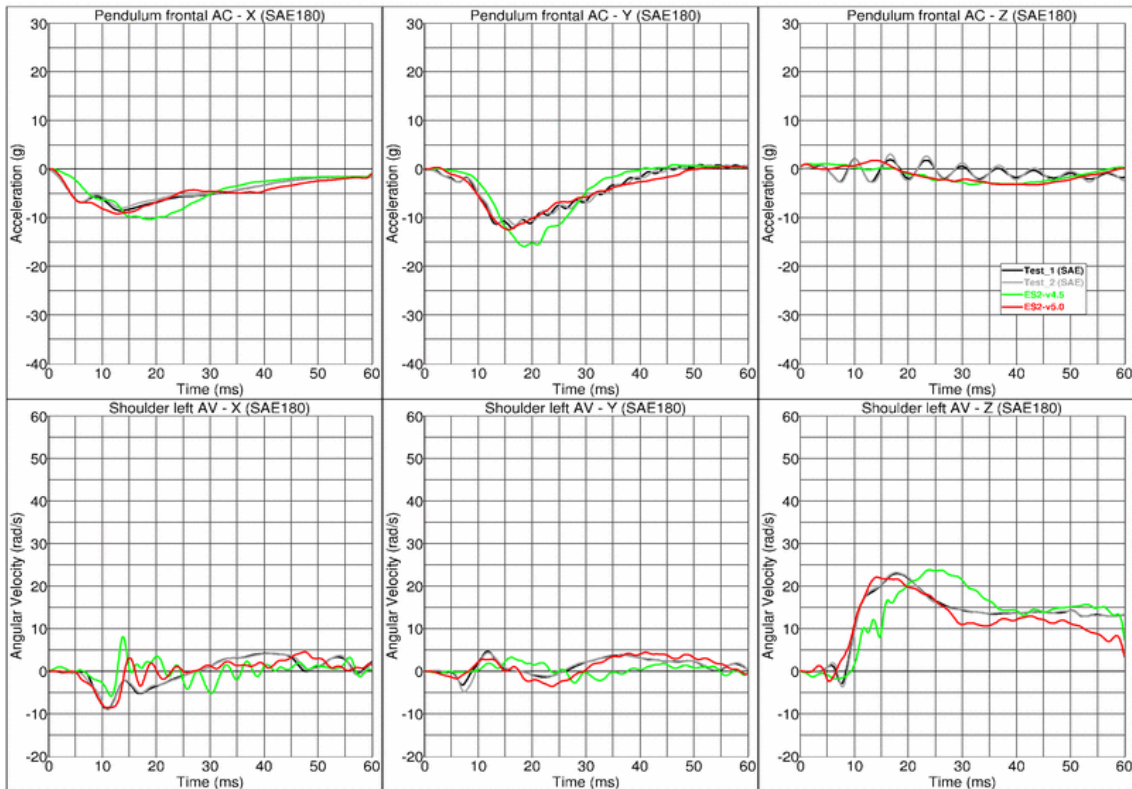

Claviclebox-Test, CBY30G, Low velocity

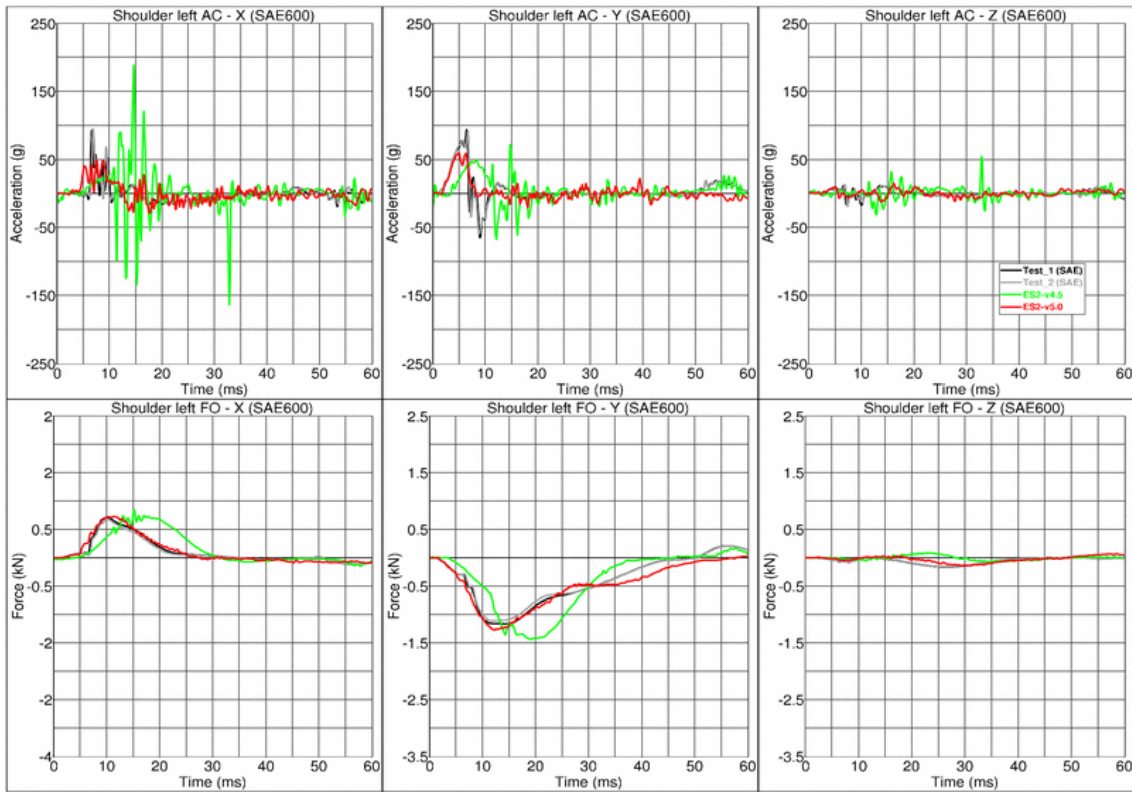

Claviclebox-Test, CBY30G, Low velocity

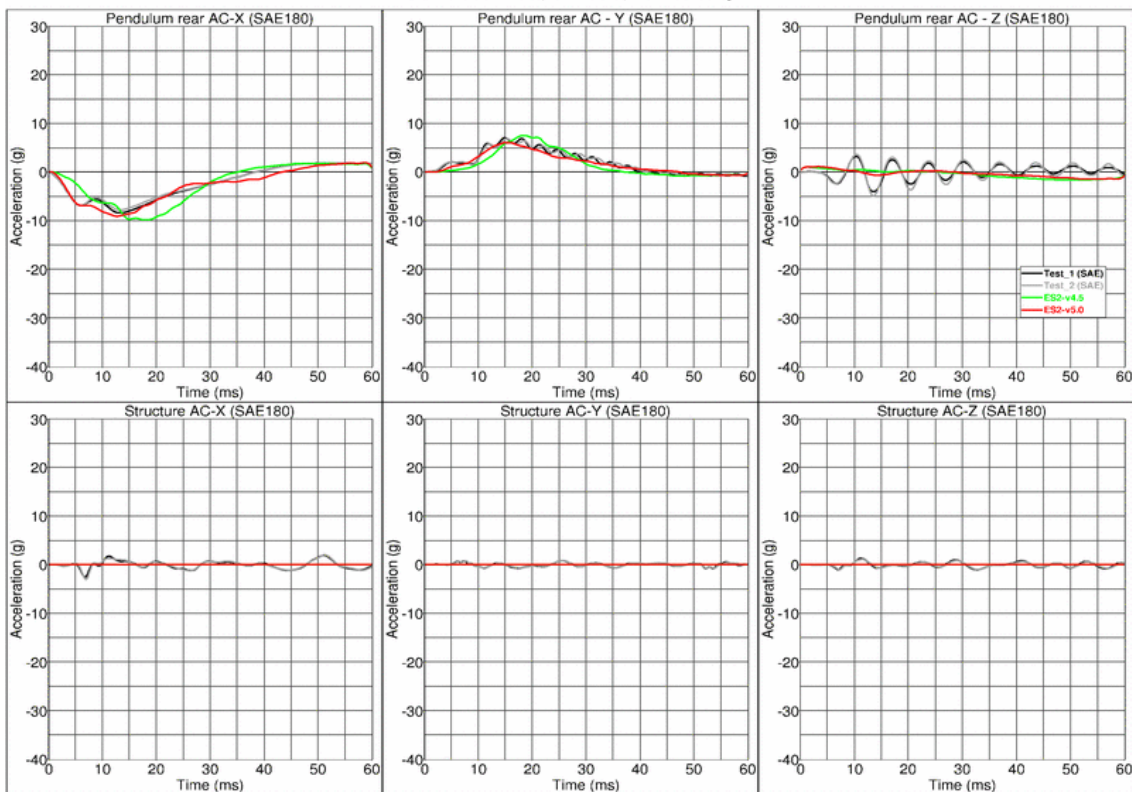

9.1.4 Abdomen slab test

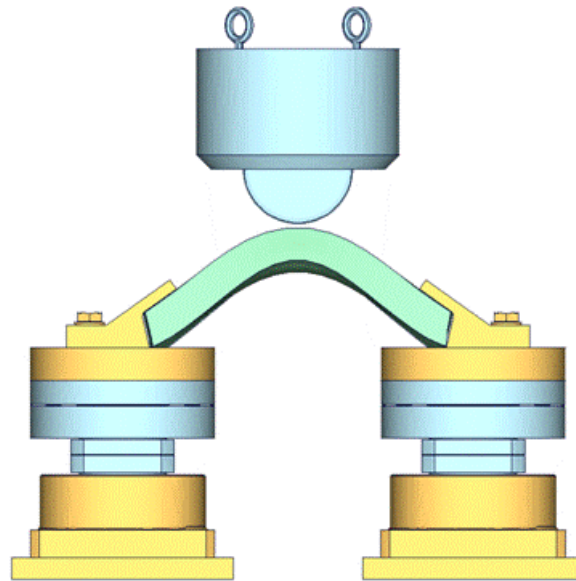
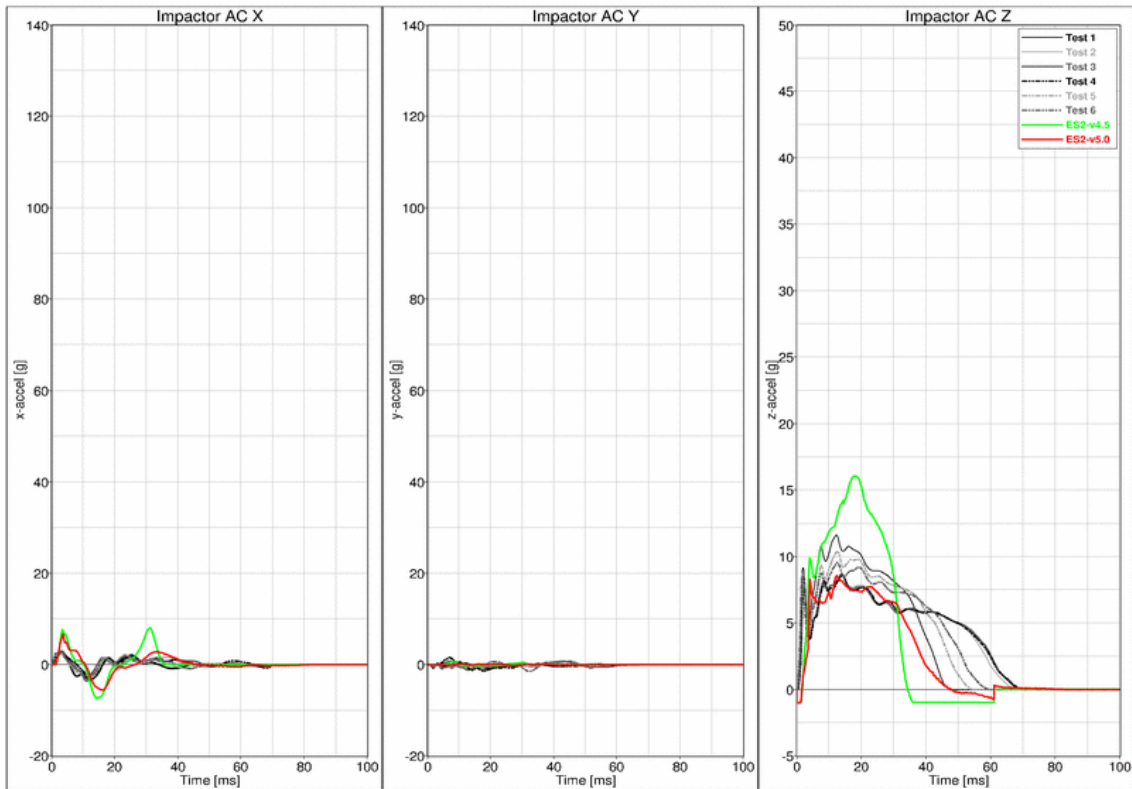

Figure 28: Test setup for Abdomen slab test

For the abdomen slab component test, the abdomen slab is held in a fixed position by two fixtures as shown in the figure above. The abdomen slab is impacted by a pendulum at 2 different velocities.

Results for low velocity impact

Abdomen slab test, High velocity



Abdomen slab test, High velocity

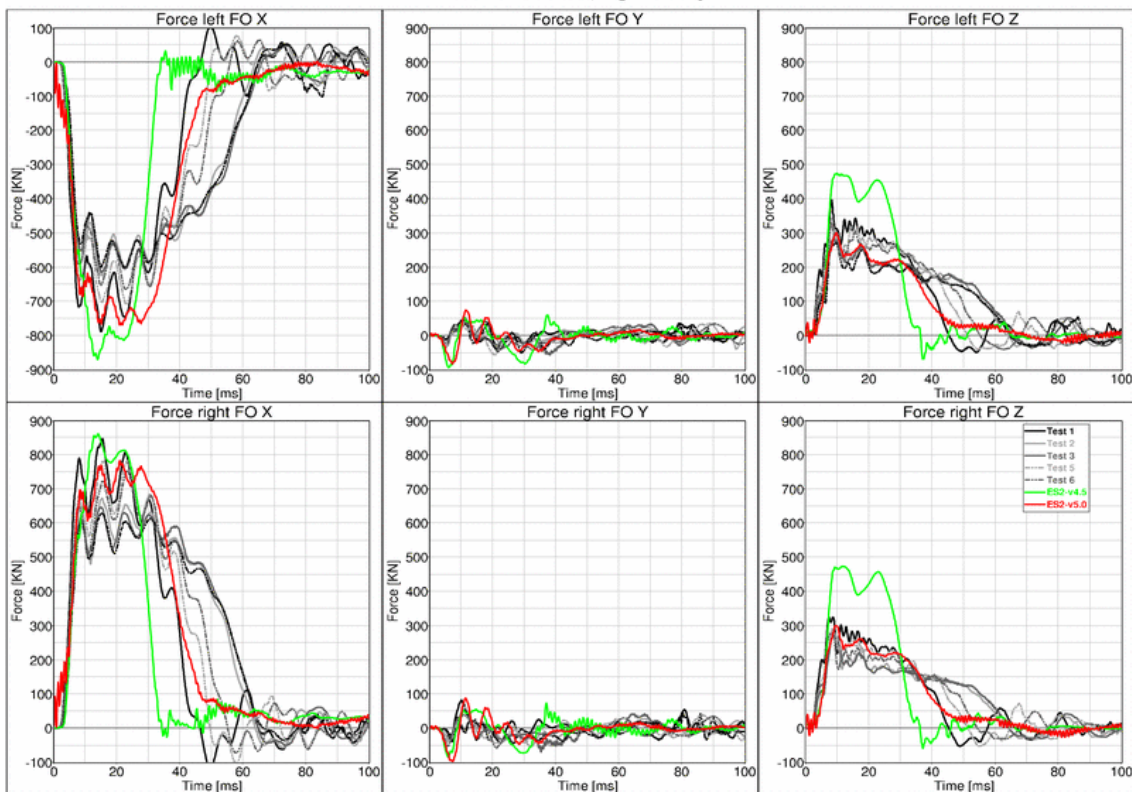

Results for high velocity impact

Abdomen slab test, High velocity

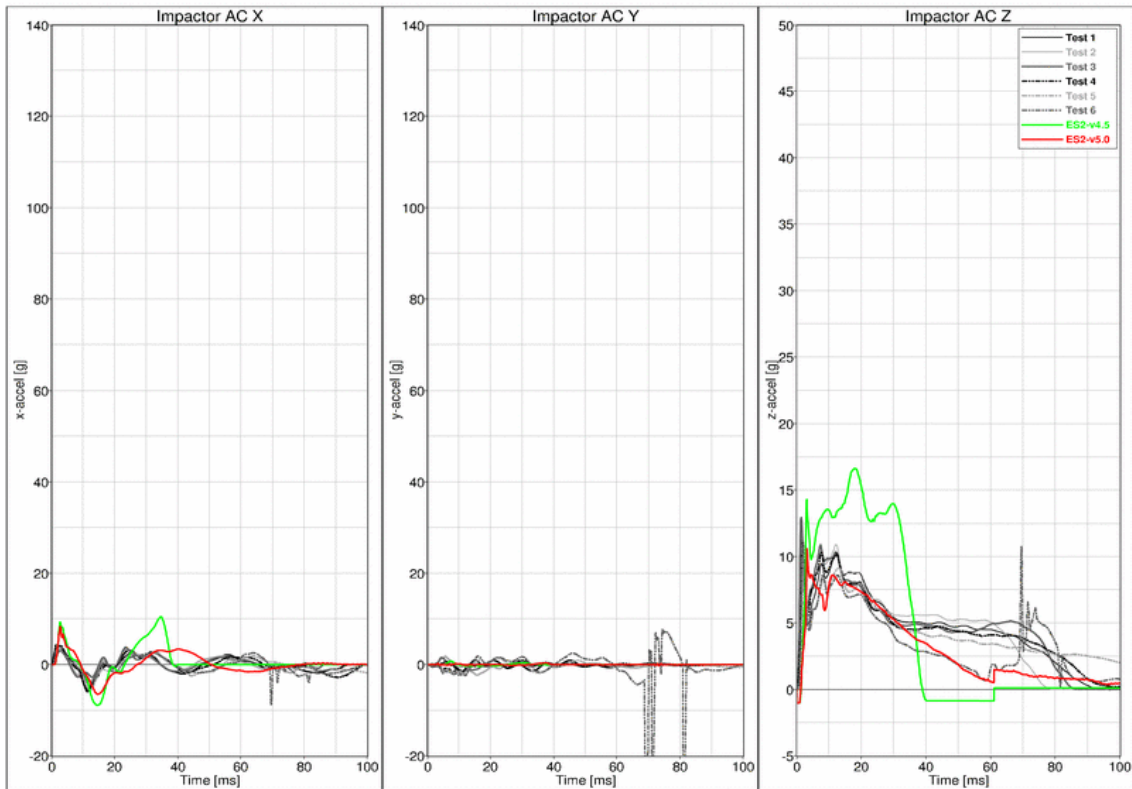

Abdomen slab test, High velocity

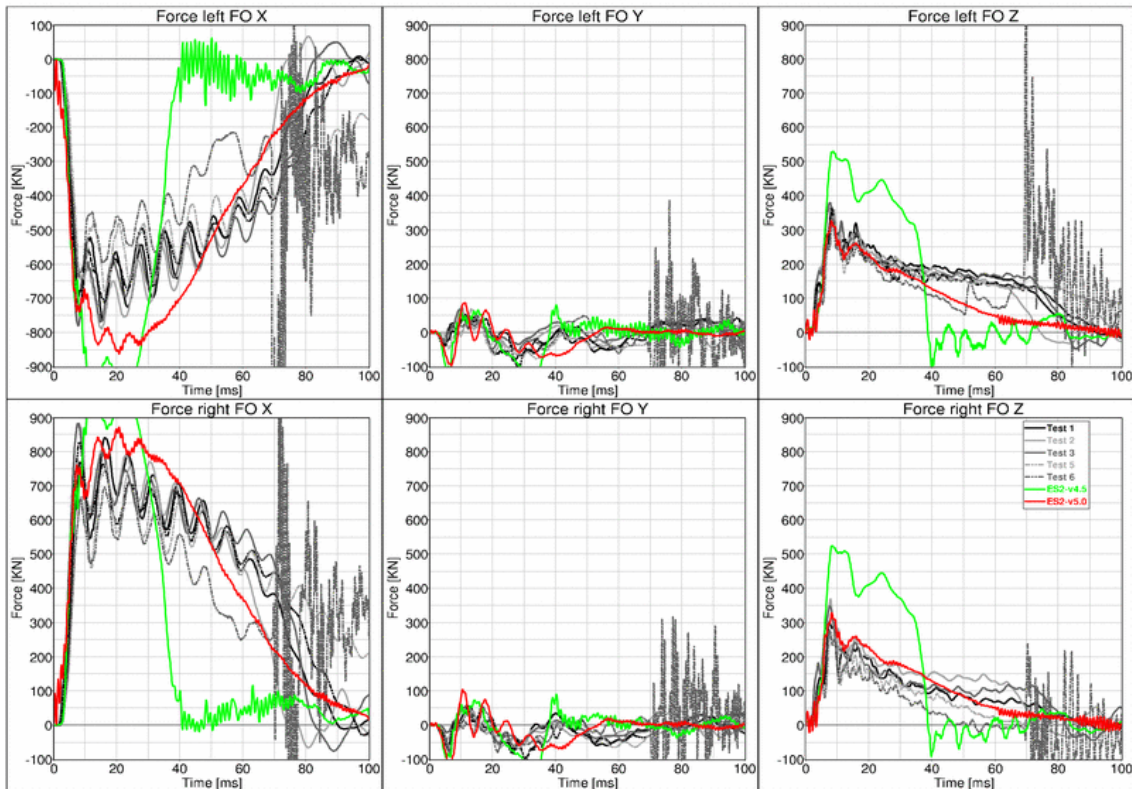

9.1.5 Abdomen test

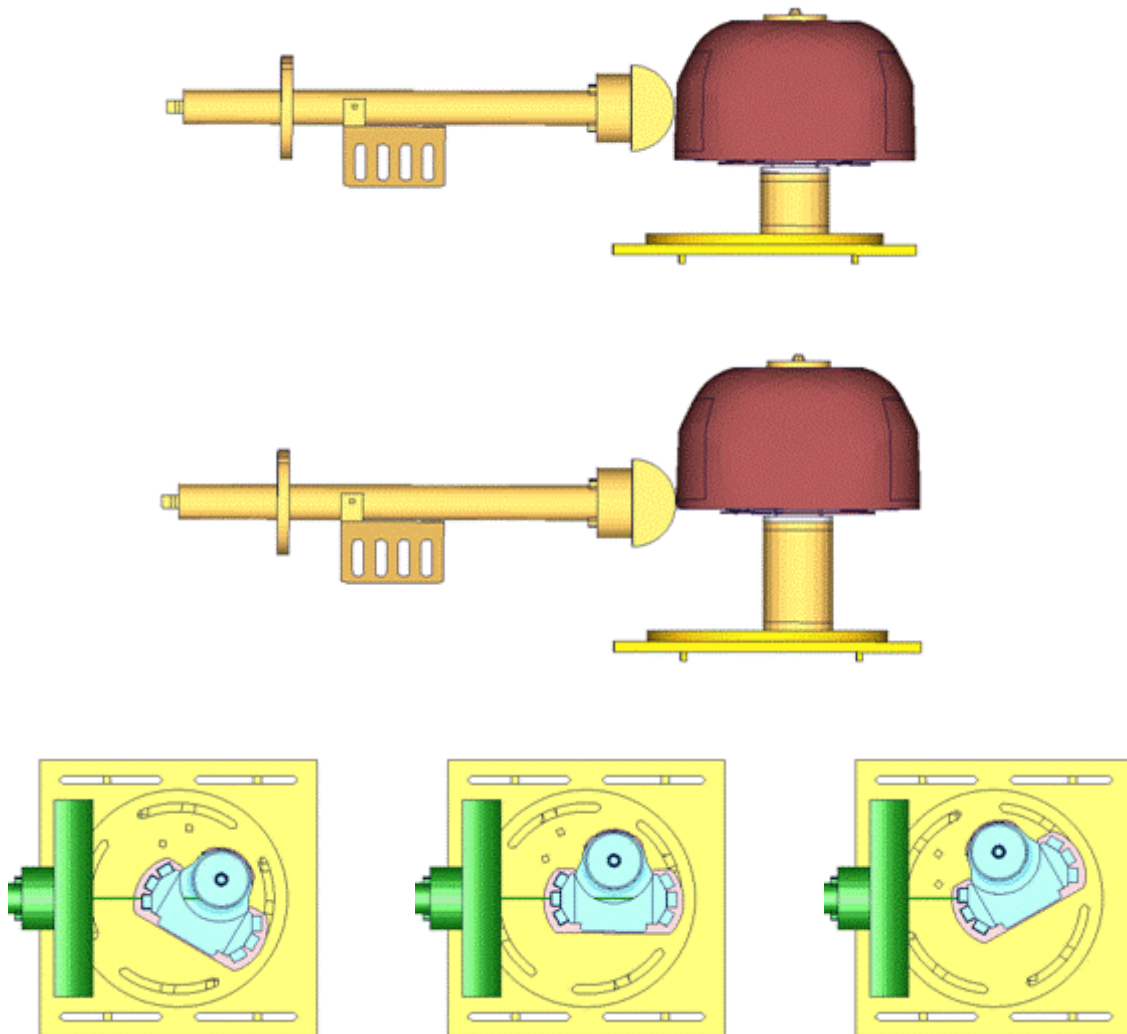
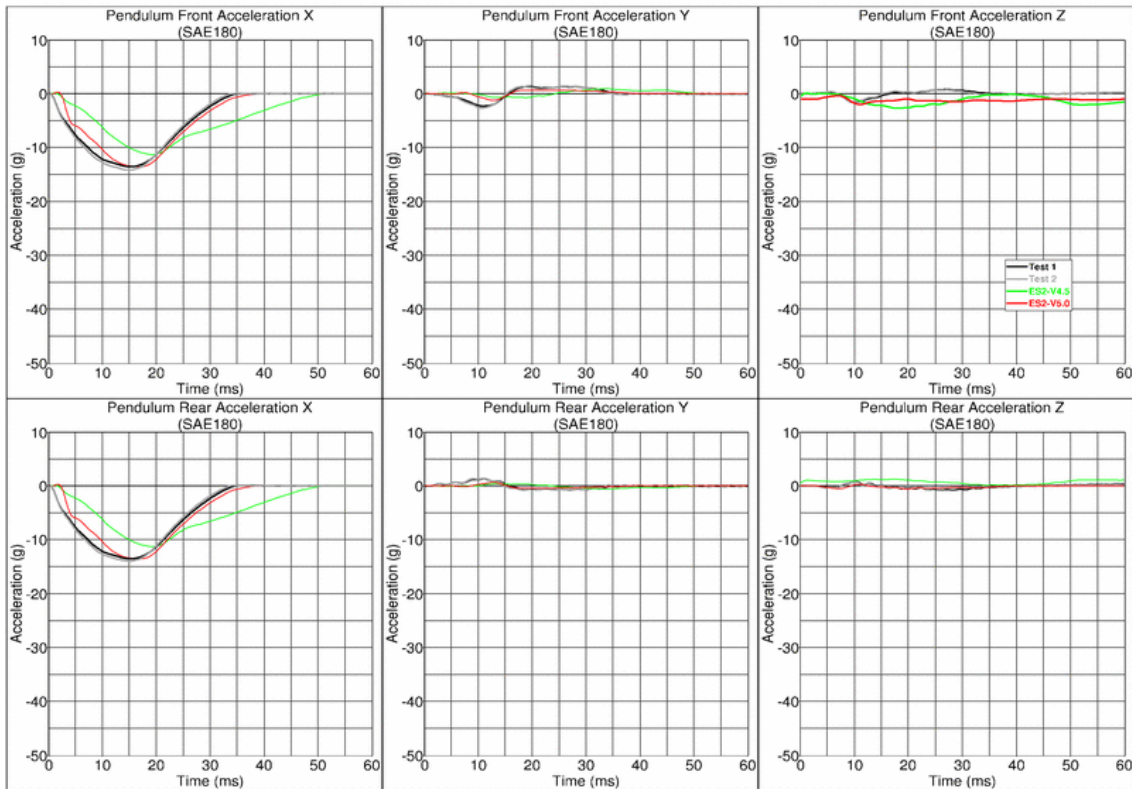

Figure 29: Test setup for Abdomen test

The test setup for the abdomen test is shown in the figure above. The Abdomen assembly is impacted by a pendulum at 2 different heights with 3 different velocities and 3 different abdomen assembly orientations each. The different abdomen assembly orientations are achieved by rotating the abdomen assembly by 30 degrees on either side of the adaptor axis.

Results for 90° orientation, middle impact, low velocity

Abdomentest - 90 Grad, Middle, Low velocity



Abdomentest - 90 Grad, Middle, Low Velocity

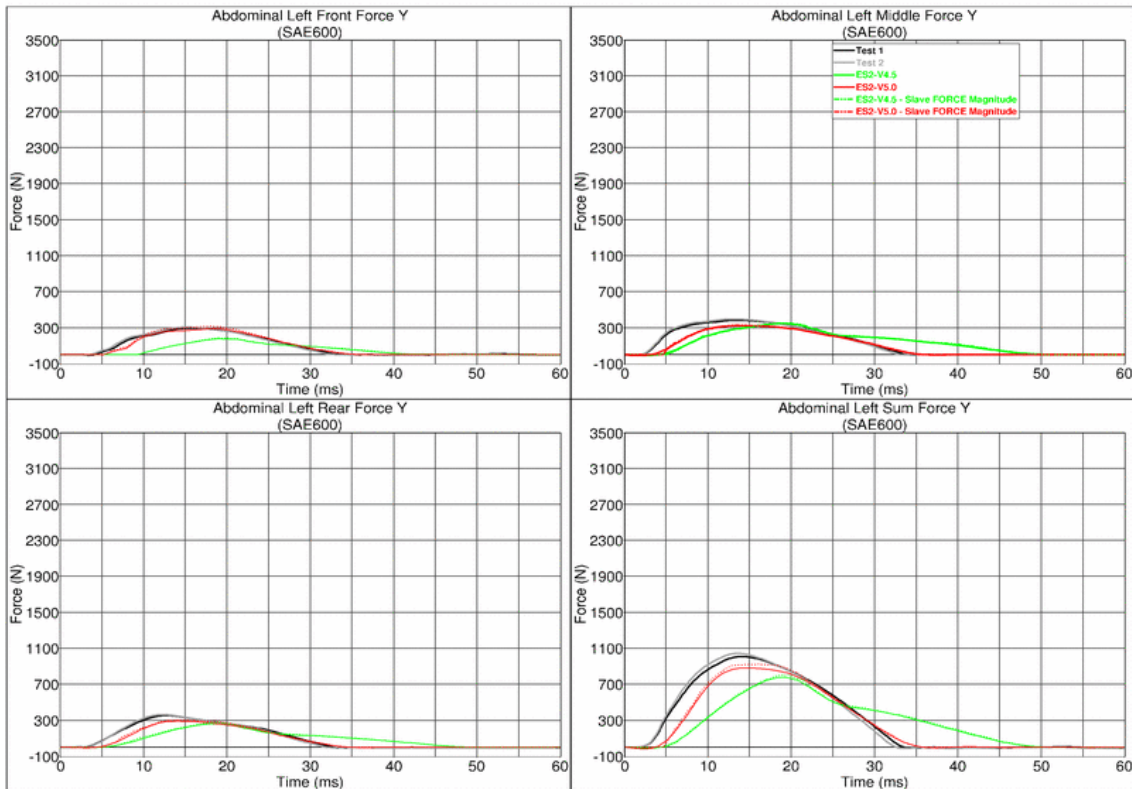

Results for 90° orientation, middle impact, medium velocity

Abdomentest - 90 Grad, Middle, Medium velocity

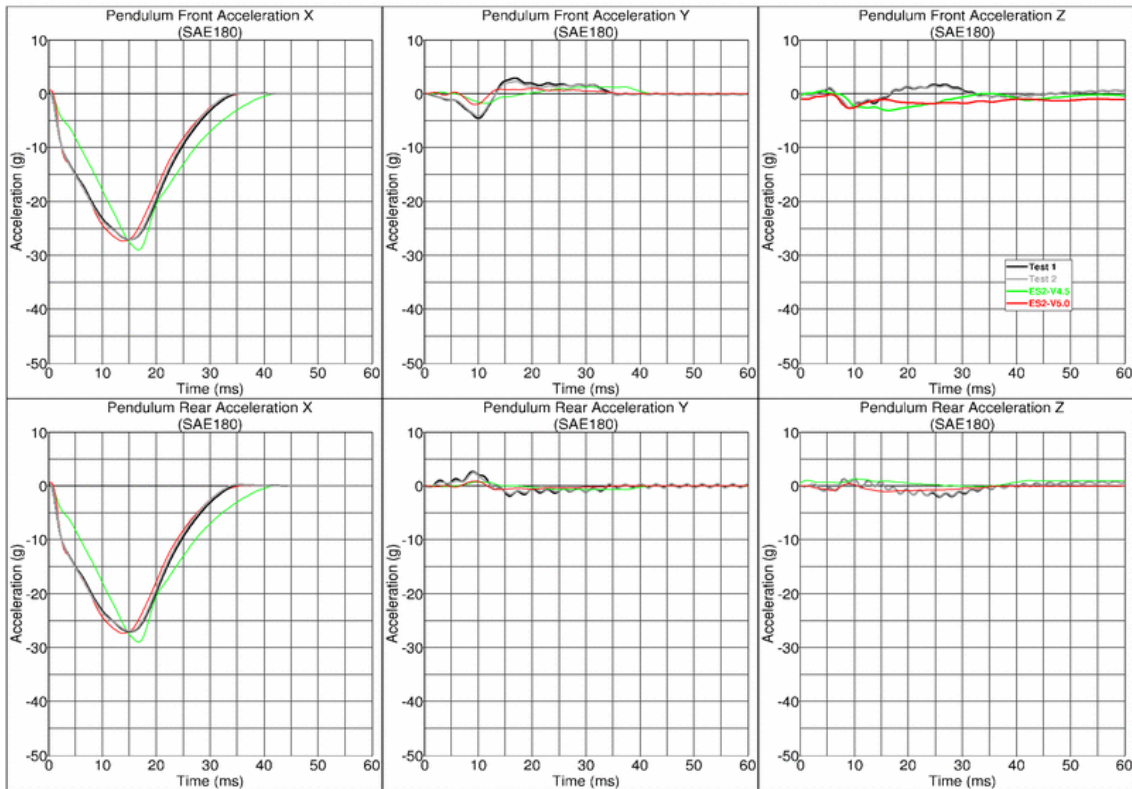

Abdomentest - 90 Grad, Middle, Medium Velocity

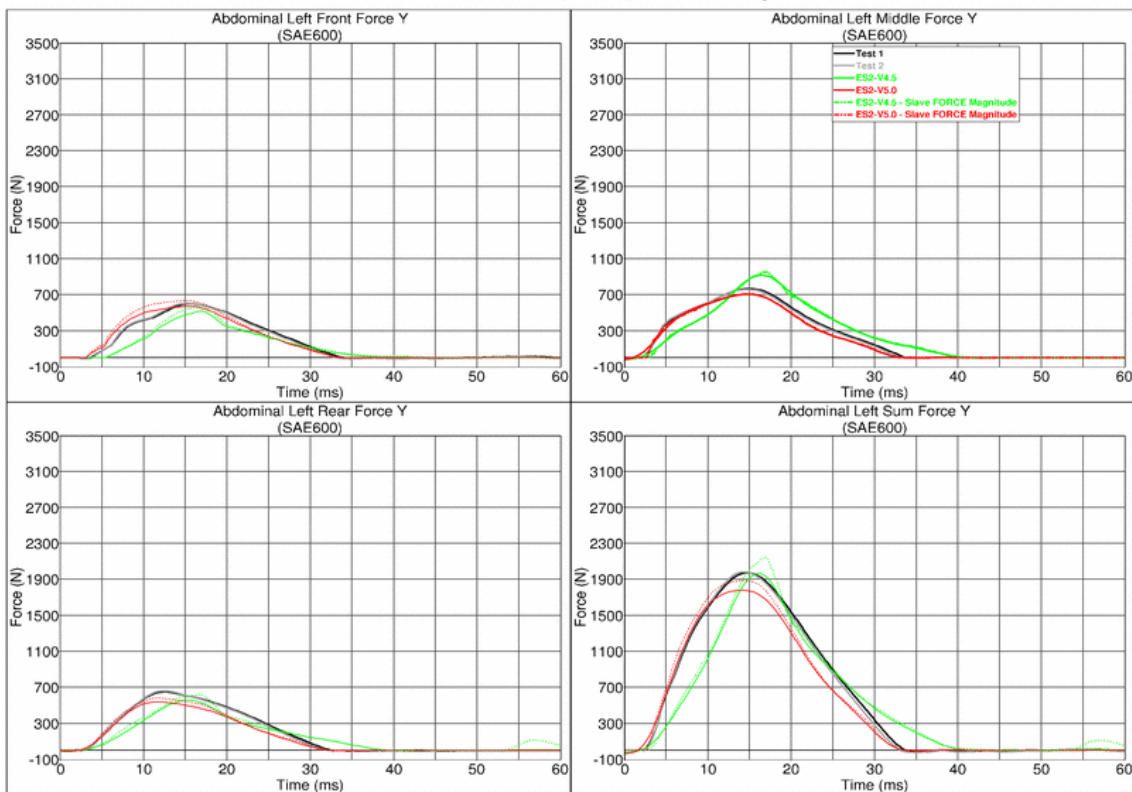

Results for 90° orientation, middle impact, high velocity

Abdomentest - 90 Grad, Middle, High velocity

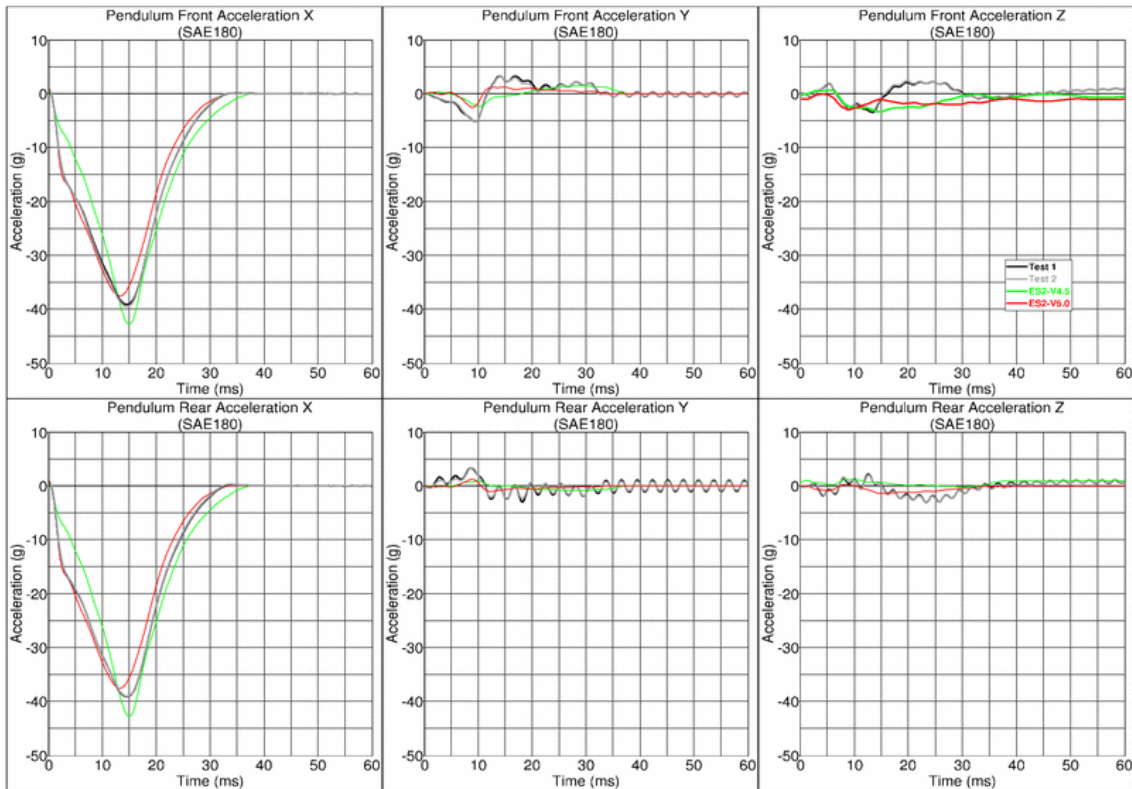

Abdomentest - 90 Grad, Middle, High Velocity

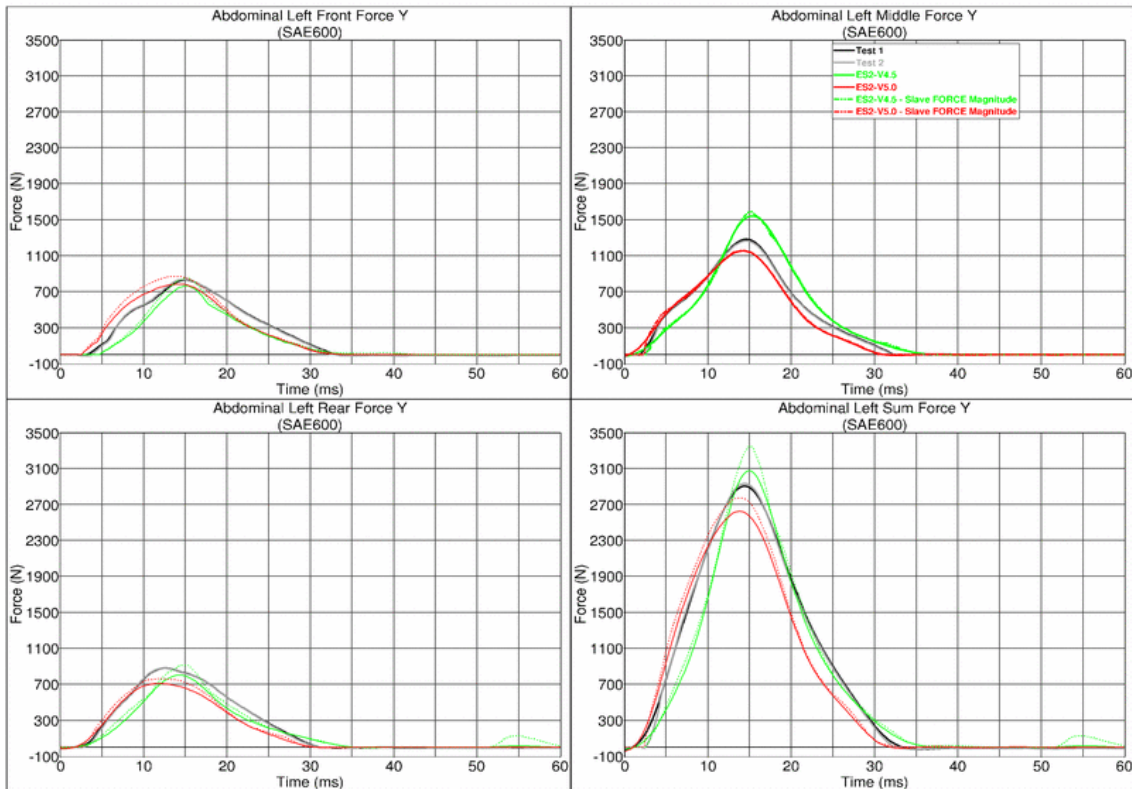

Results for 60° orientation, middle impact, low velocity

Abdomentest - 60 Grad, Middle, Low velocity

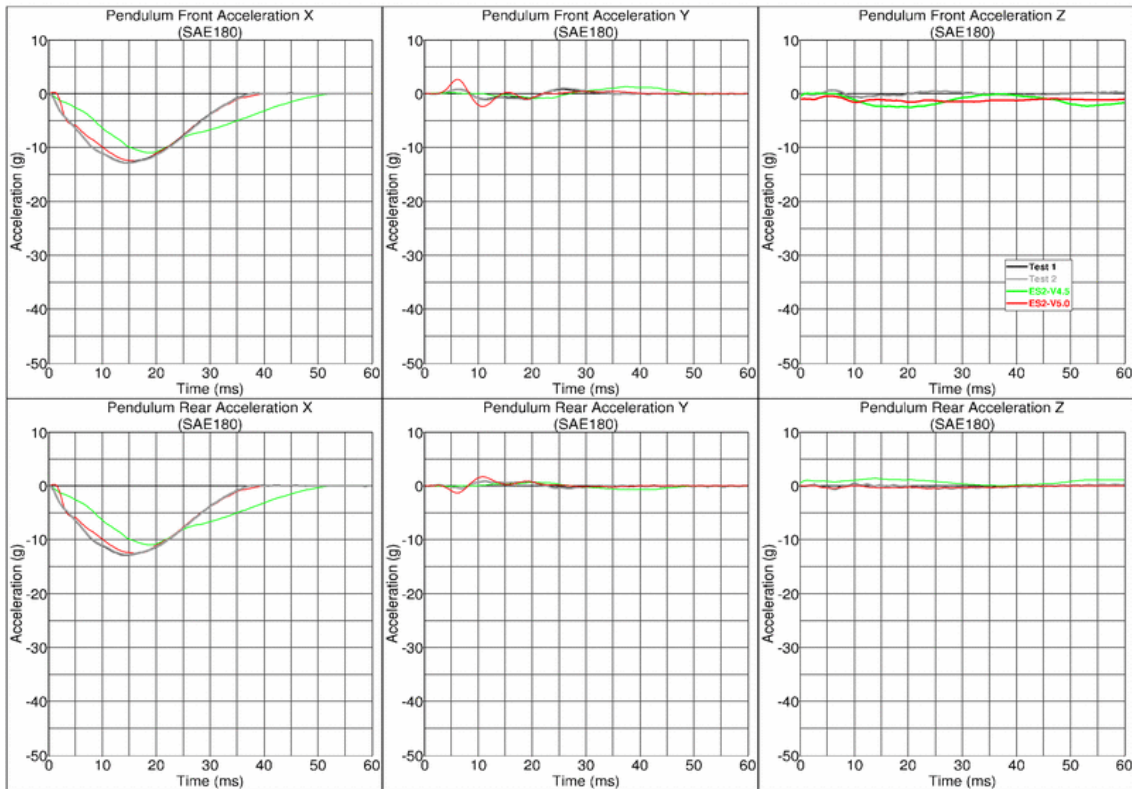

Abdomentest - 60 Grad, Middle, Low Velocity

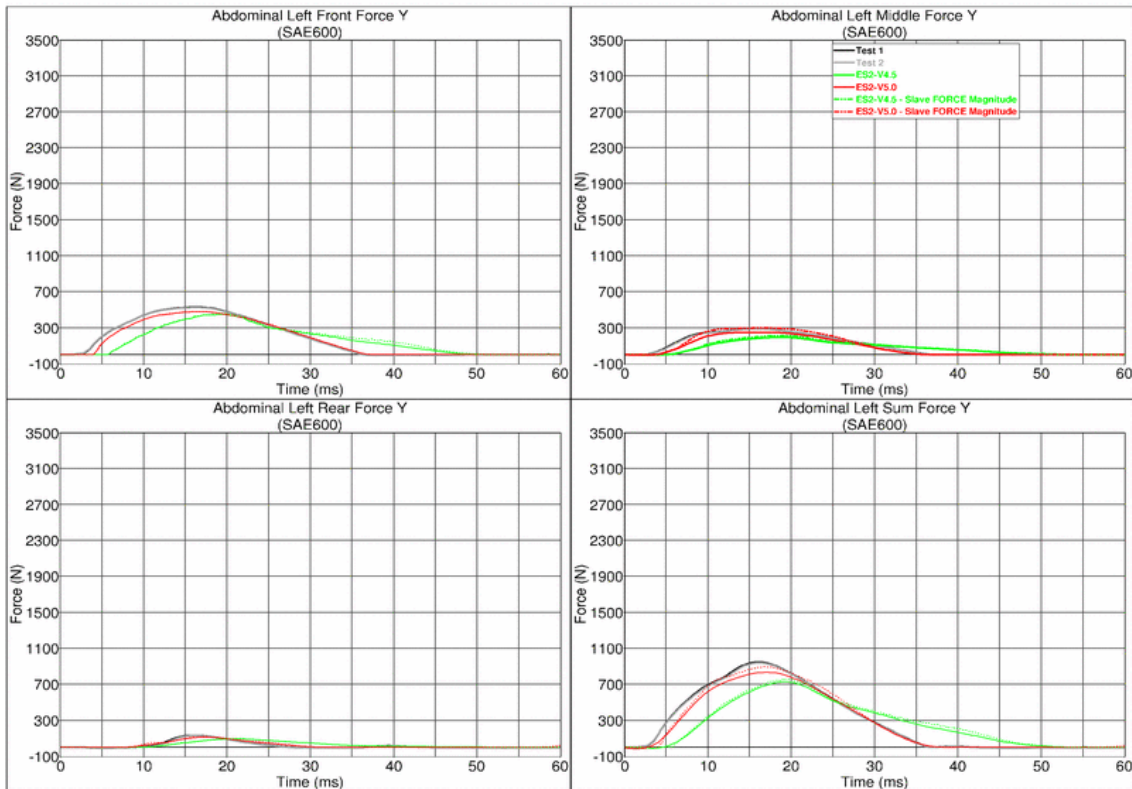

Results for 60° orientation, middle impact, medium velocity

Abdomentest - 60 Grad, Middle, Medium velocity

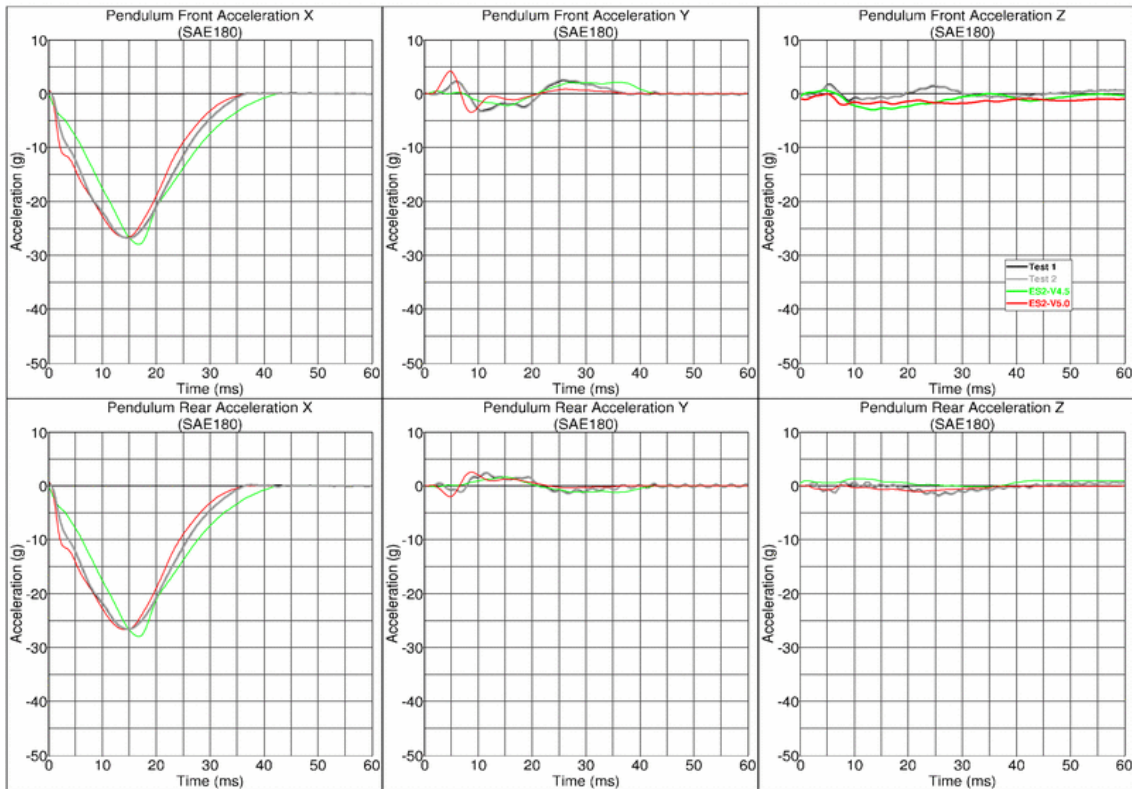

Abdomentest - 60 Grad, Middle, Medium Velocity

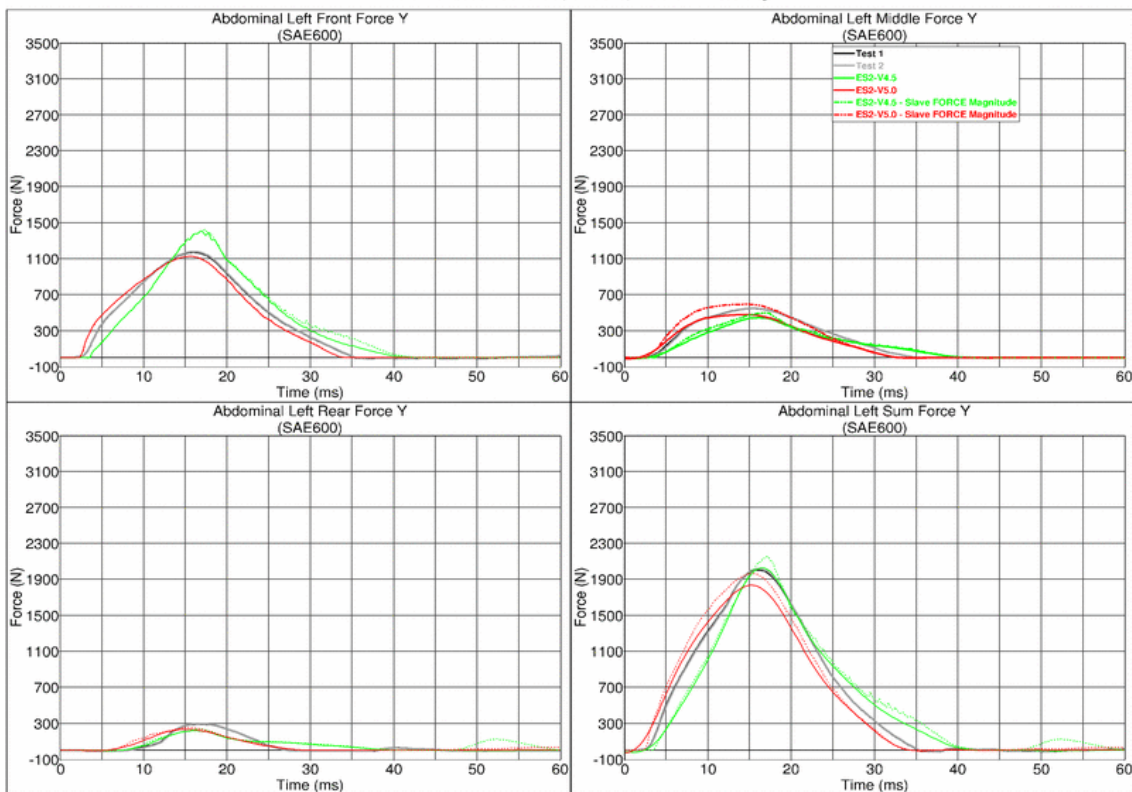

Results for 60° orientation, middle impact, high velocity

Abdomentest - 60 Grad, Middle, High velocity

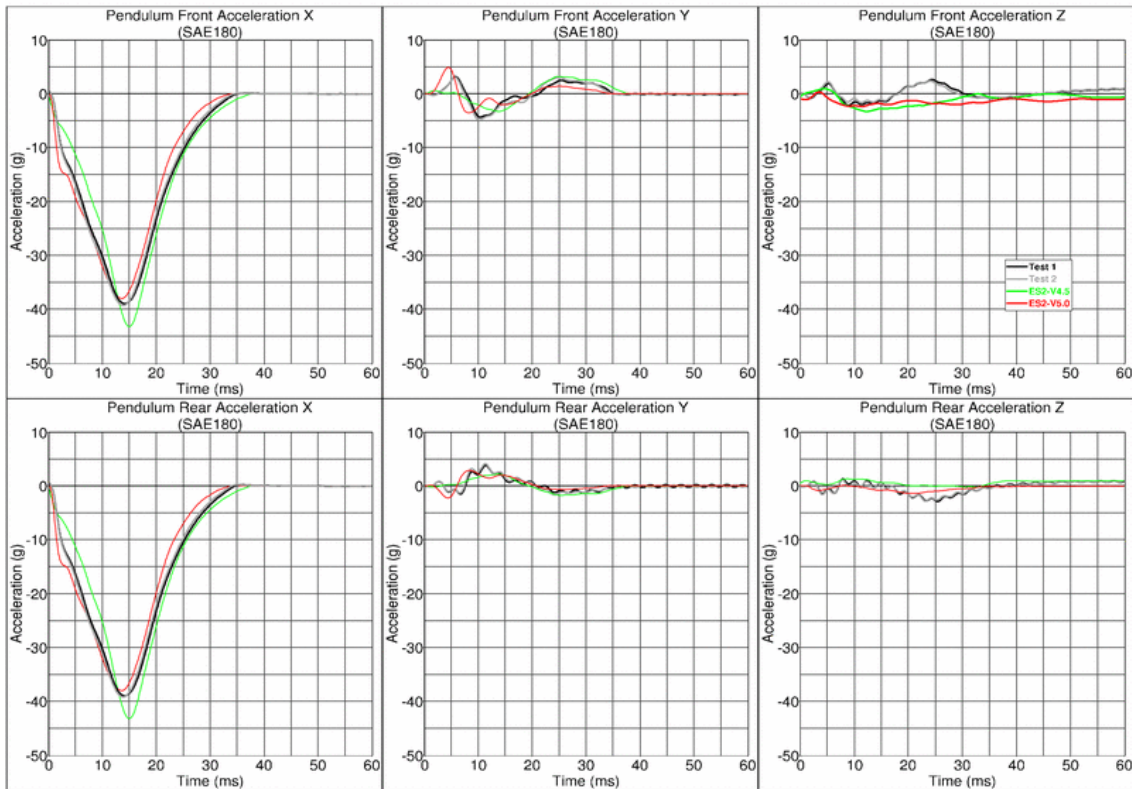

Abdomentest - 60 Grad, Middle, High Velocity

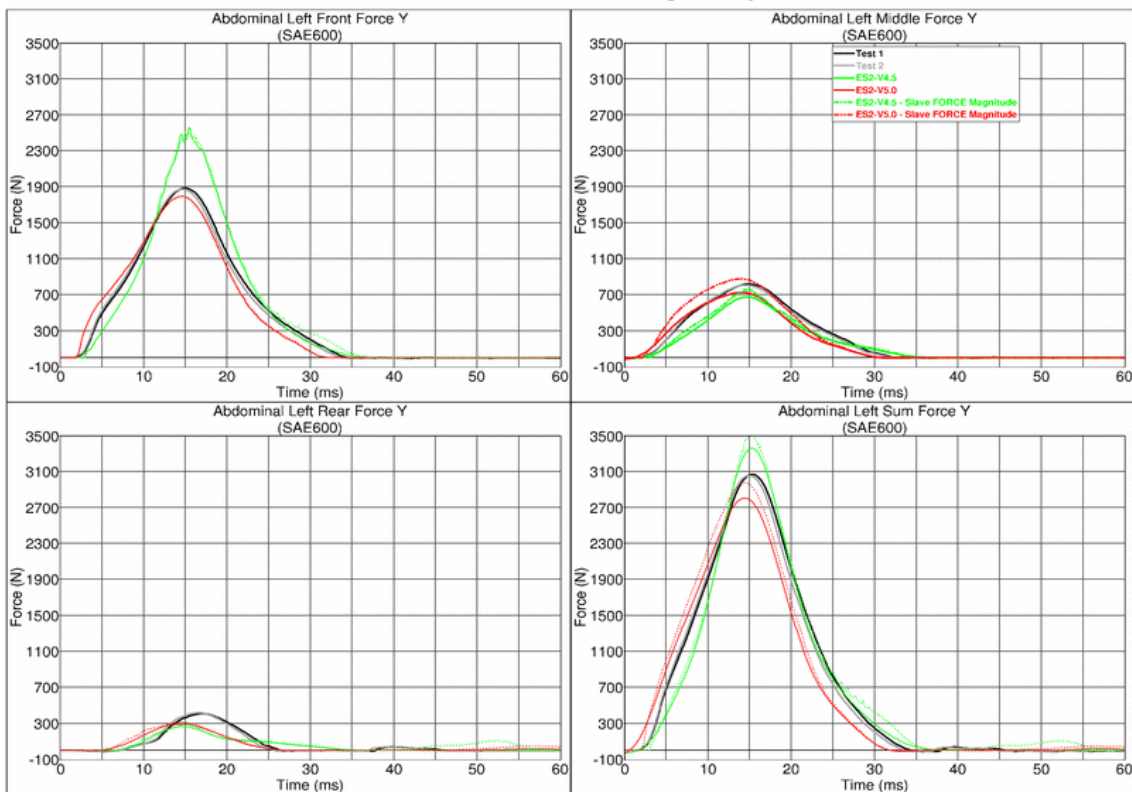

Results for 120° orientation, middle impact, low velocity

Abdomentest - 120 Grad, Middle, Low velocity

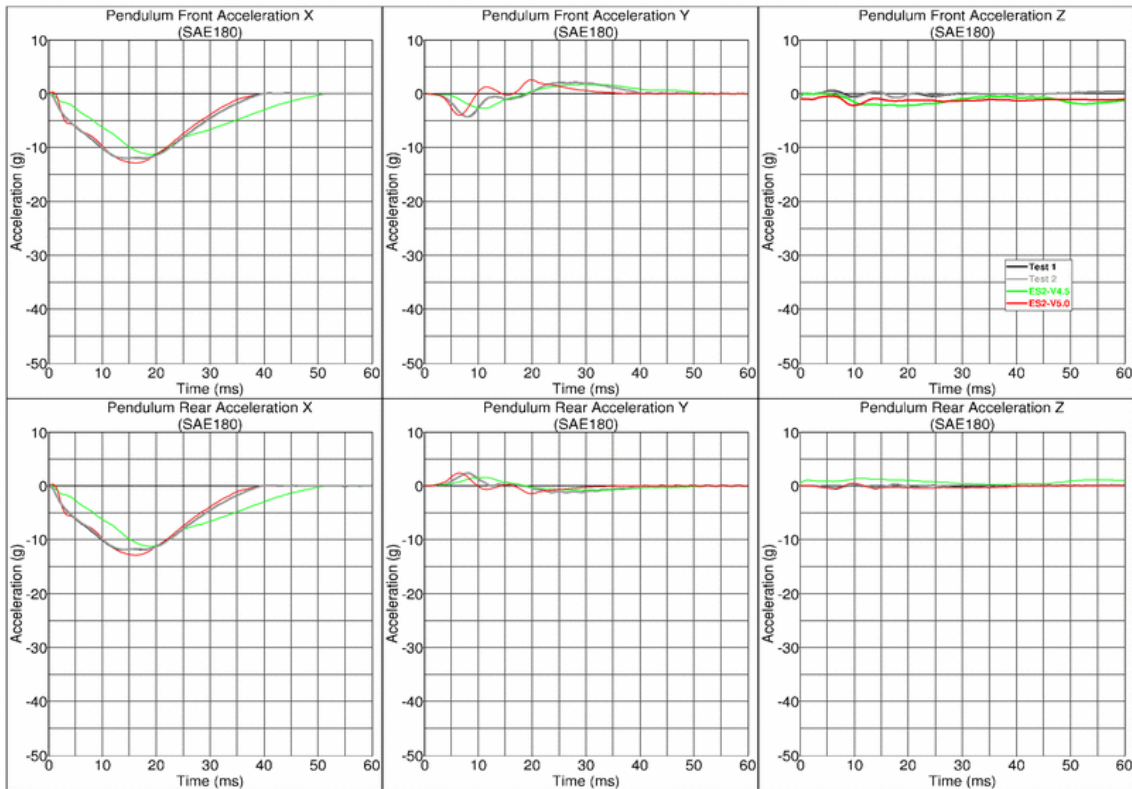

Abdomentest - 120 Grad, Middle, Low Velocity

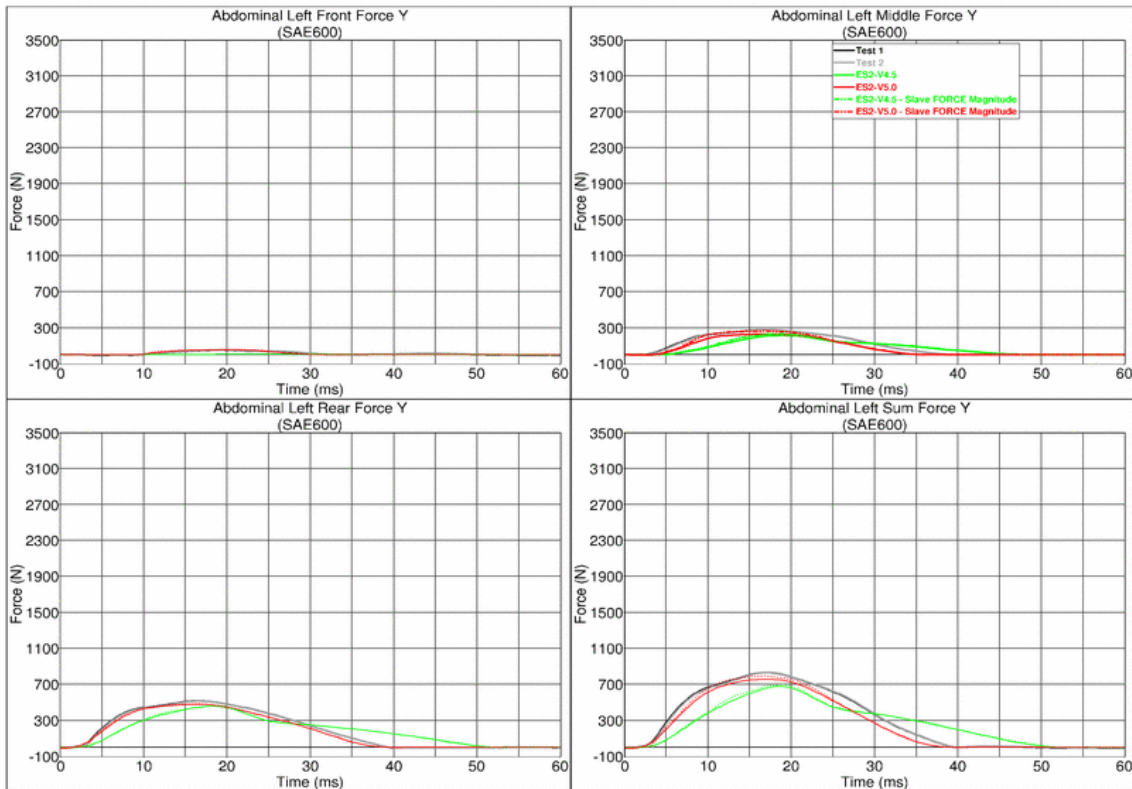

Results for 120° orientation, middle impact, medium velocity

Abdomentest - 120 Grad, Middle, Medium velocity

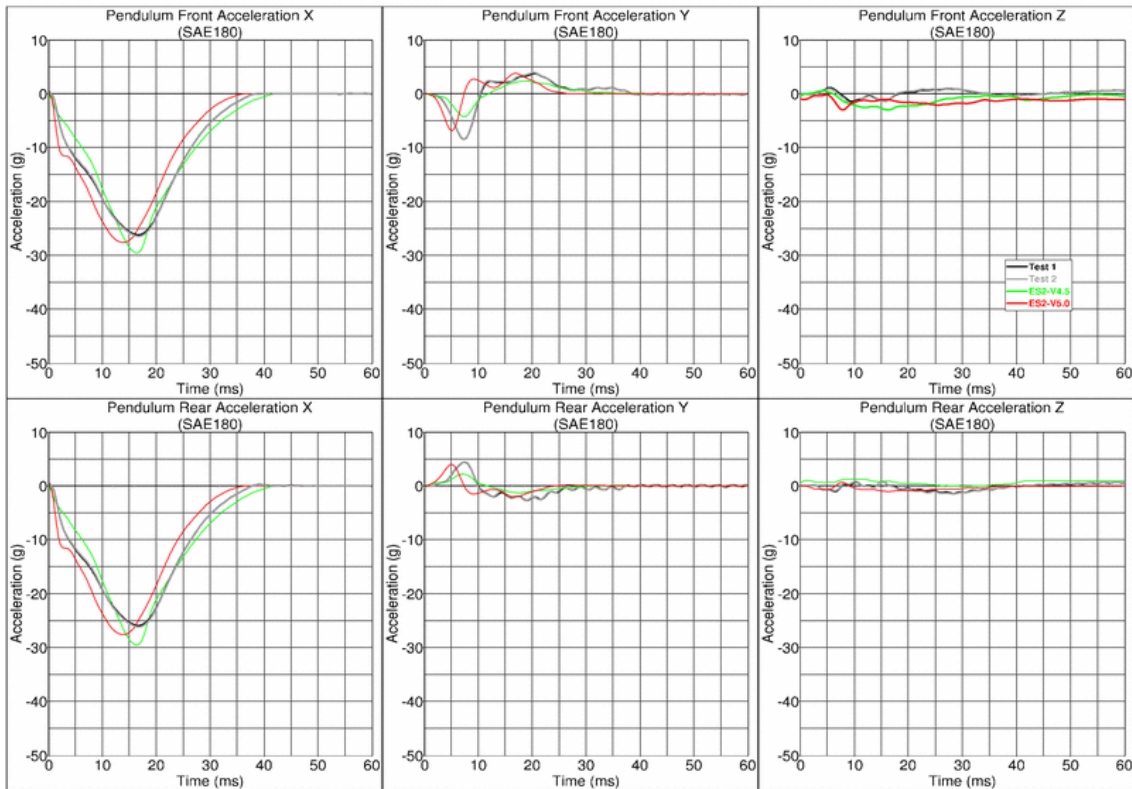

Abdomentest - 120 Grad, Middle, Medium Velocity

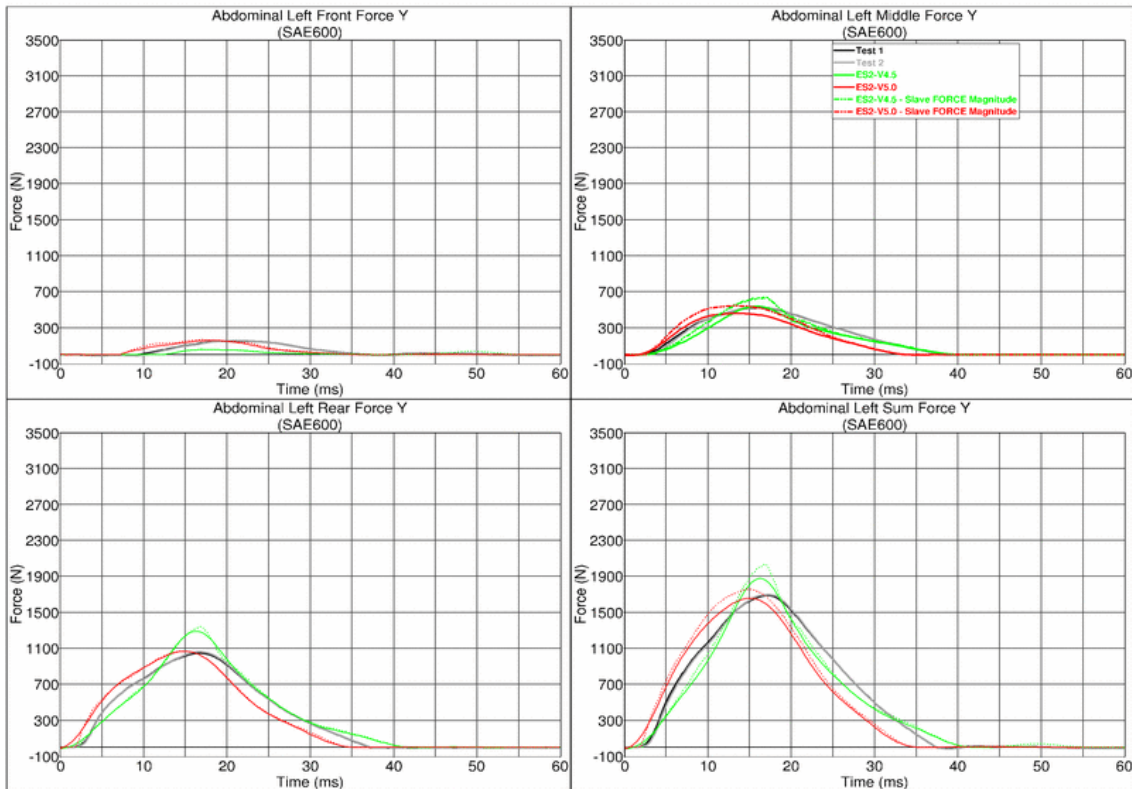

Results for 120° orientation, middle impact, high velocity

Abdomentest - 120 Grad, Middle, High velocity

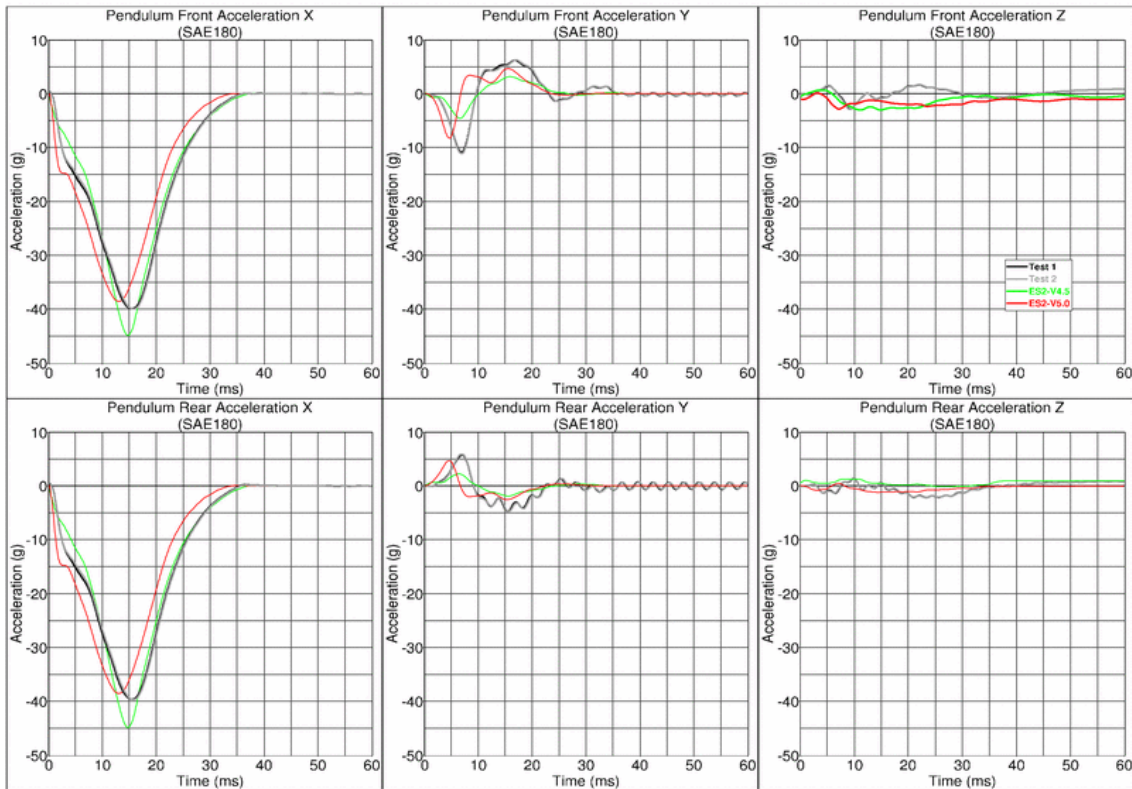

Abdomentest - 120 Grad, Middle, High Velocity

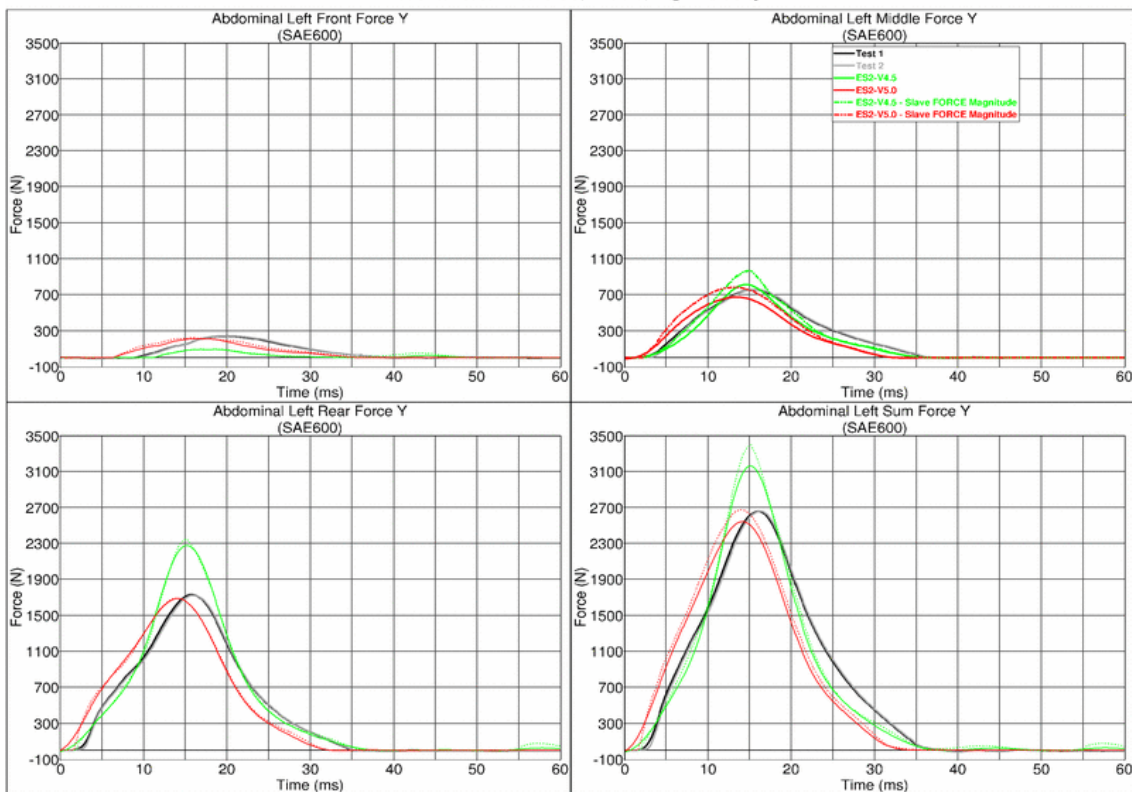

Results for 90° orientation, top impact, low velocity

Abdomentest - 90 Grad, Top, Low velocity

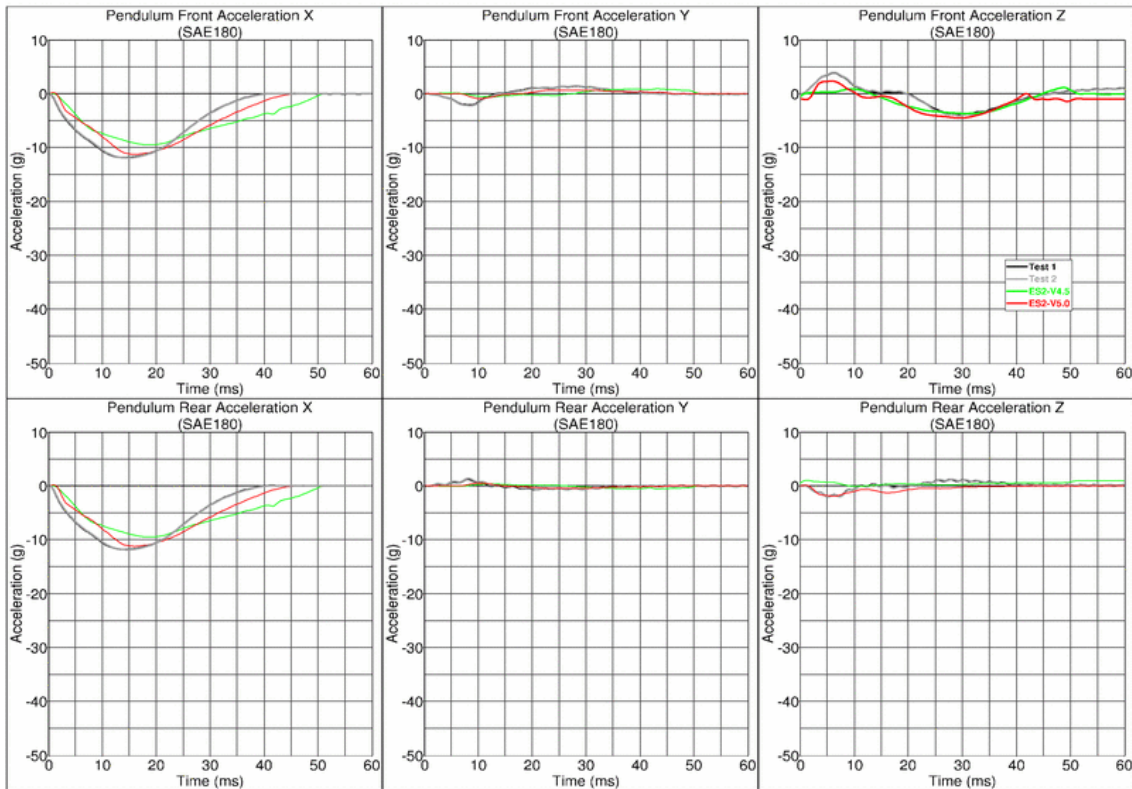

Abdomentest - 90 Grad, Top, Low Velocity

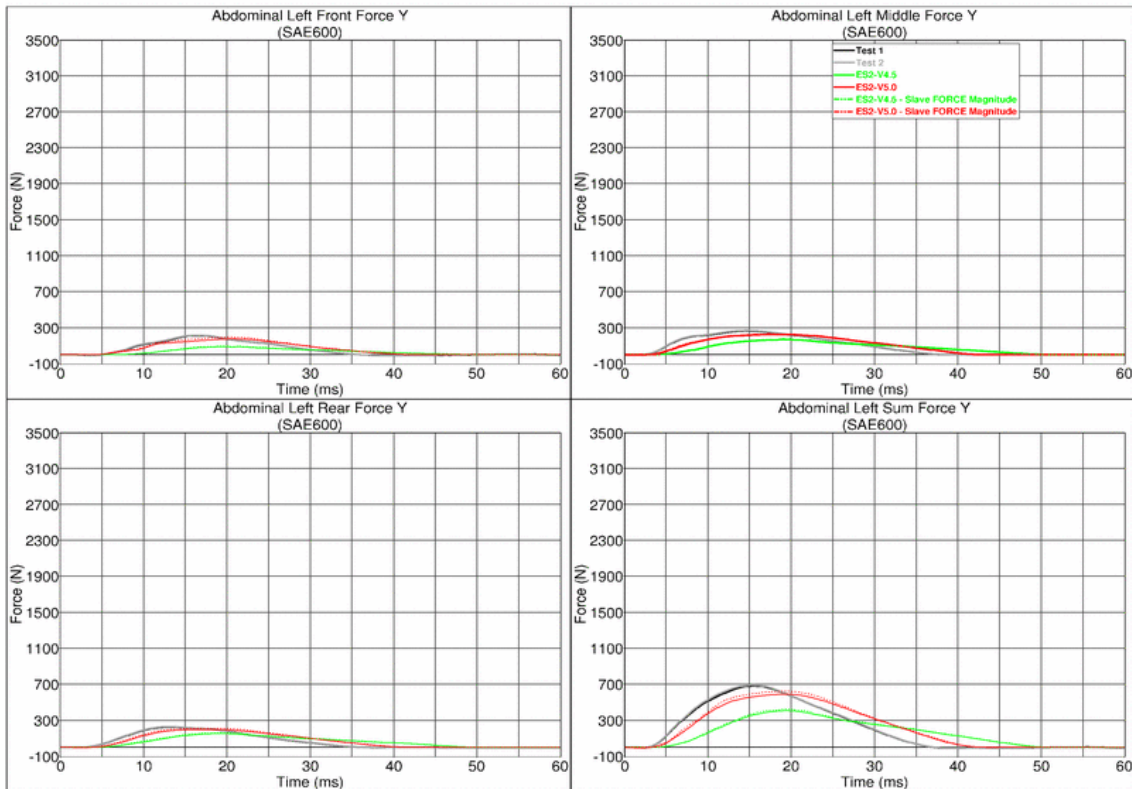

Results for 90° orientation, top impact, medium velocity

Abdomentest - 90 Grad, Top, Medium velocity

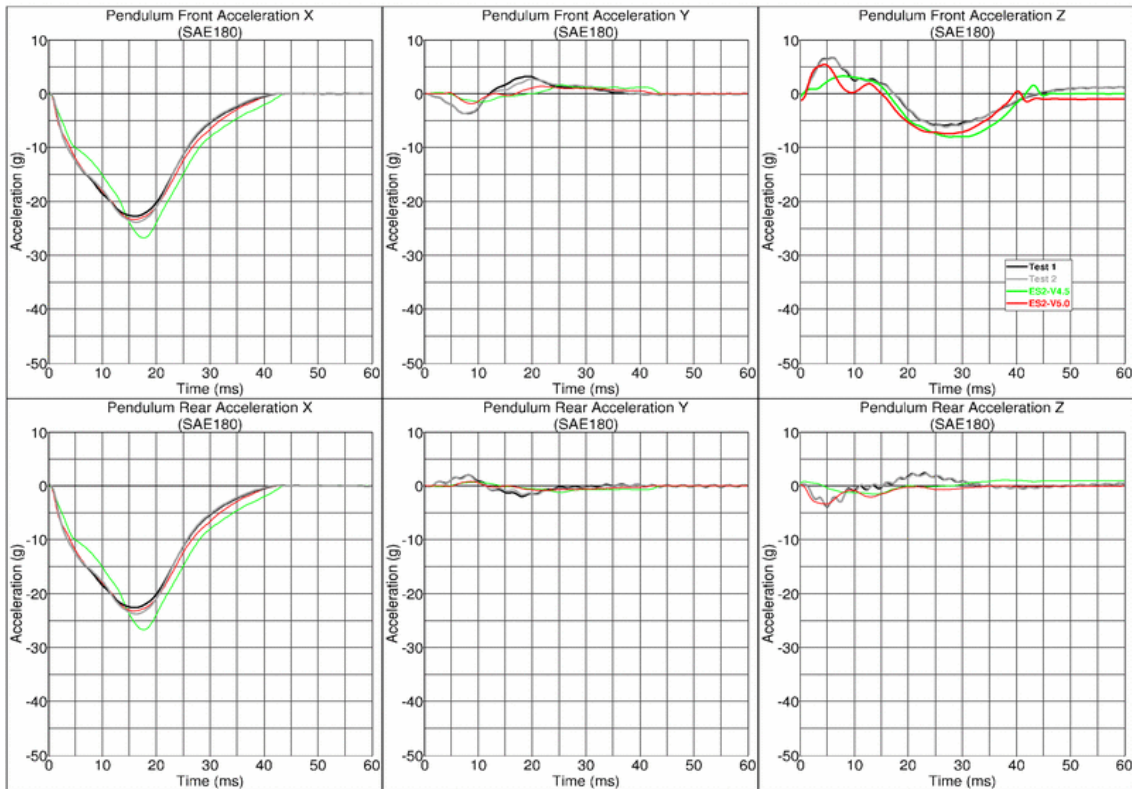

Abdomentest - 90 Grad, Top, Medium Velocity

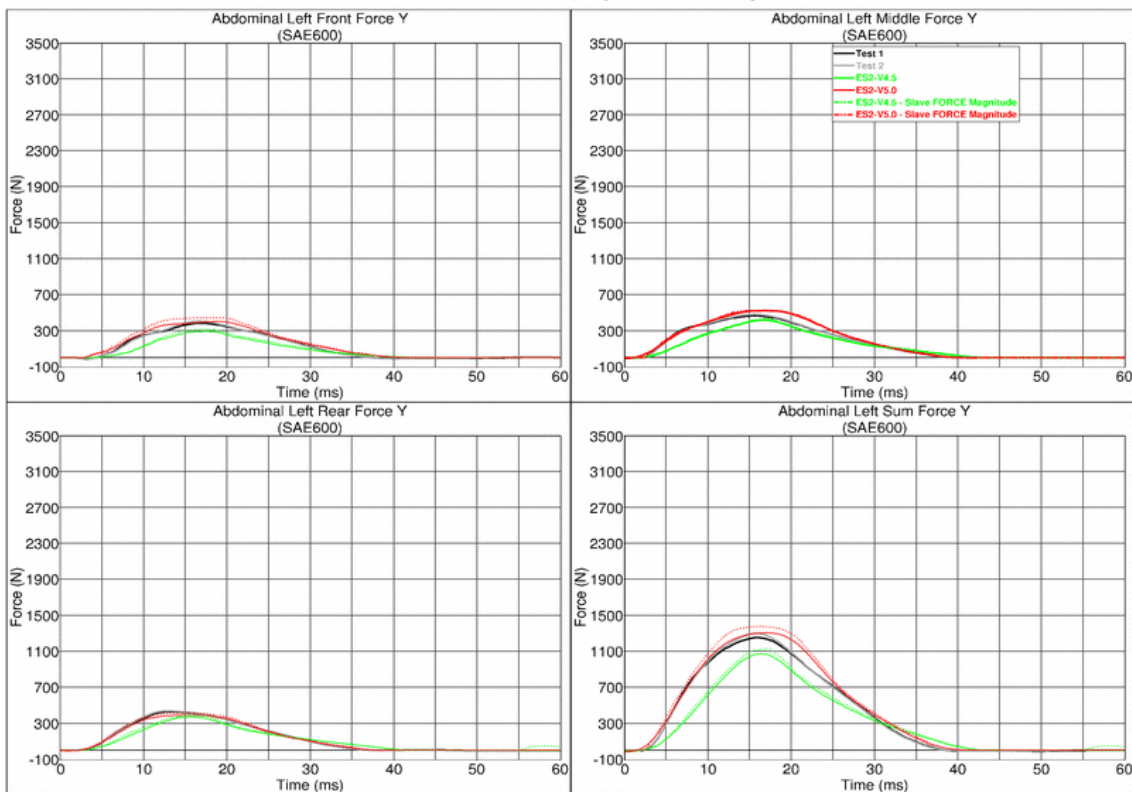

Results for 90° orientation, top impact, high velocity

Abdomentest - 90 Grad, Top, High velocity

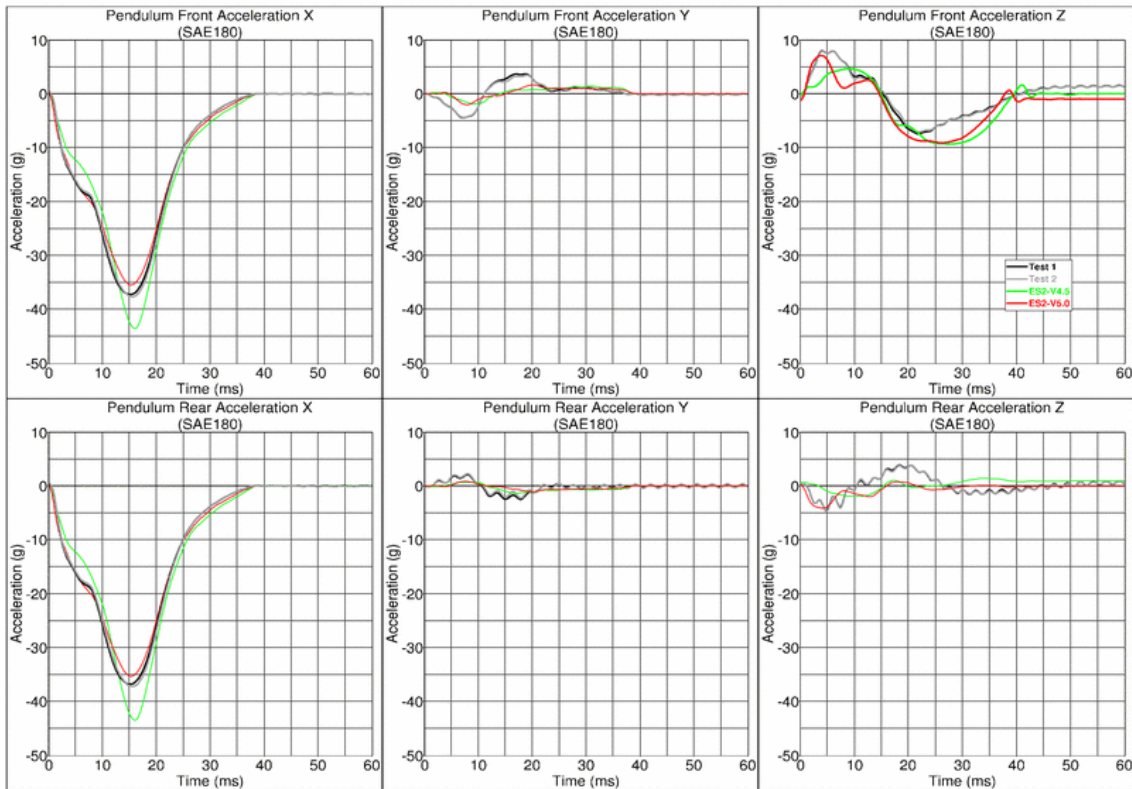

Abdomentest - 90 Grad, Top, High Velocity

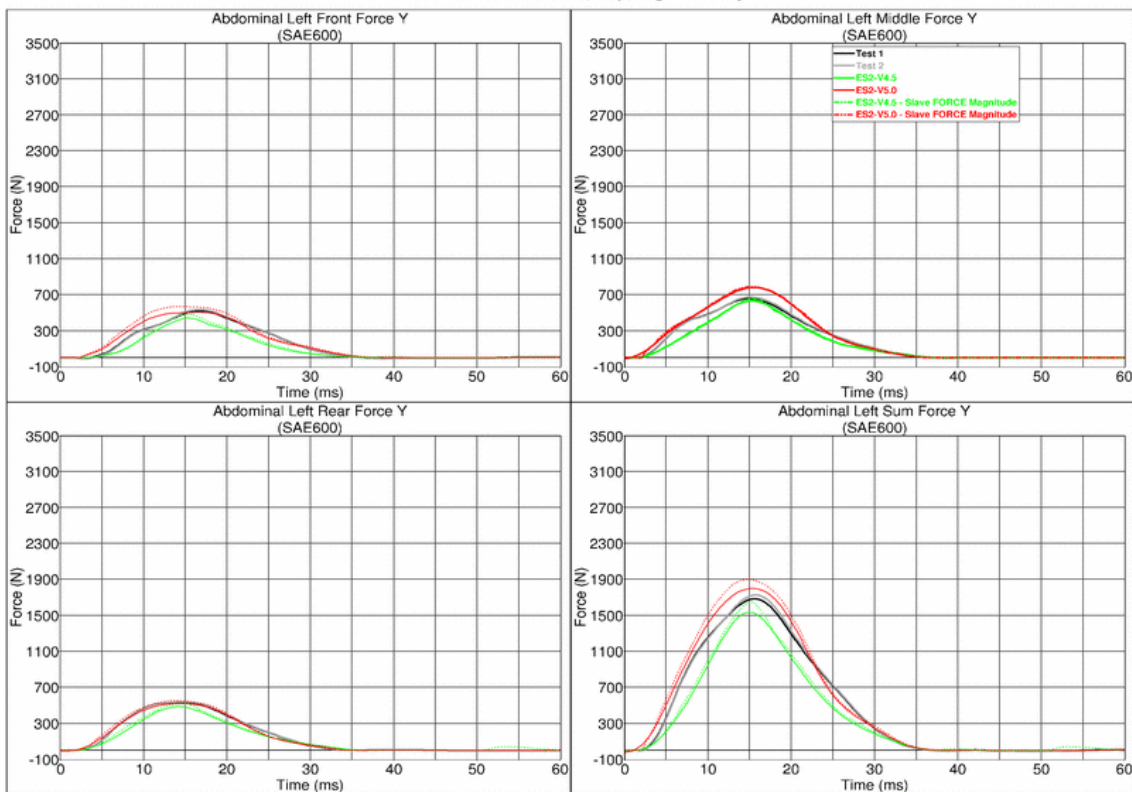

Results for 60° orientation, top impact, low velocity

Abdomentest - 60 Grad, Top, Low velocity

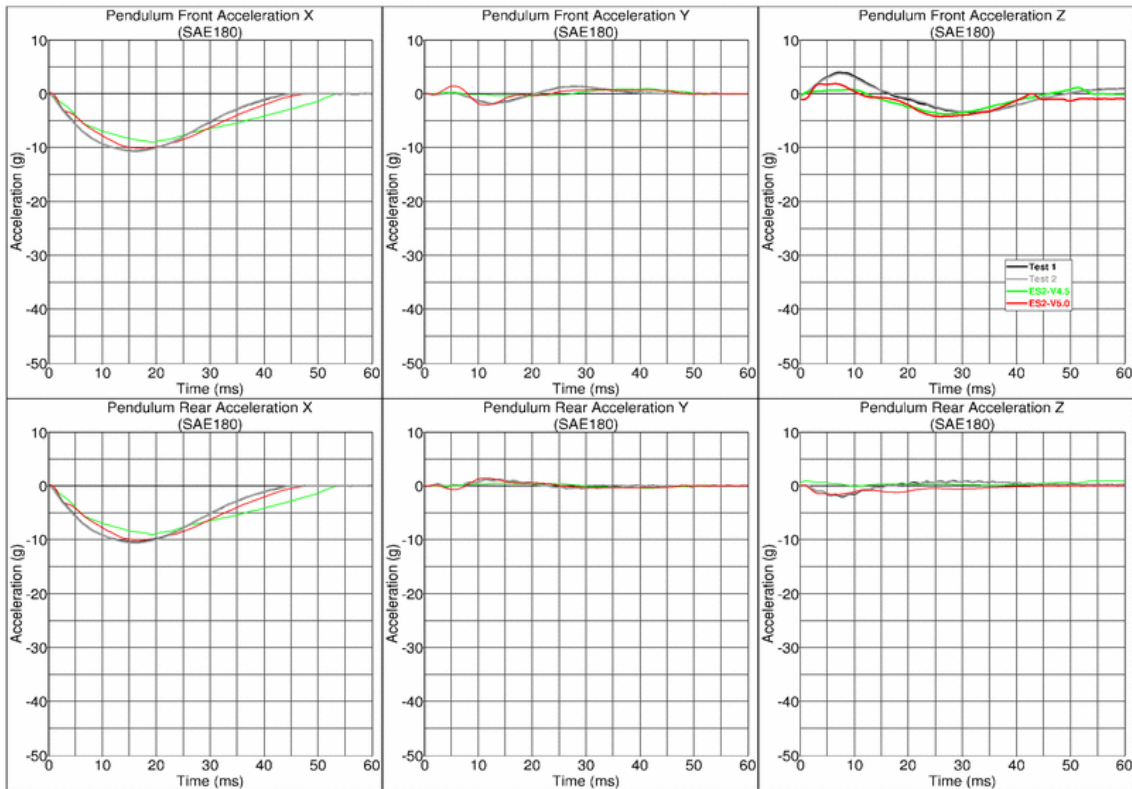

Abdomentest - 60 Grad, Top, Low Velocity

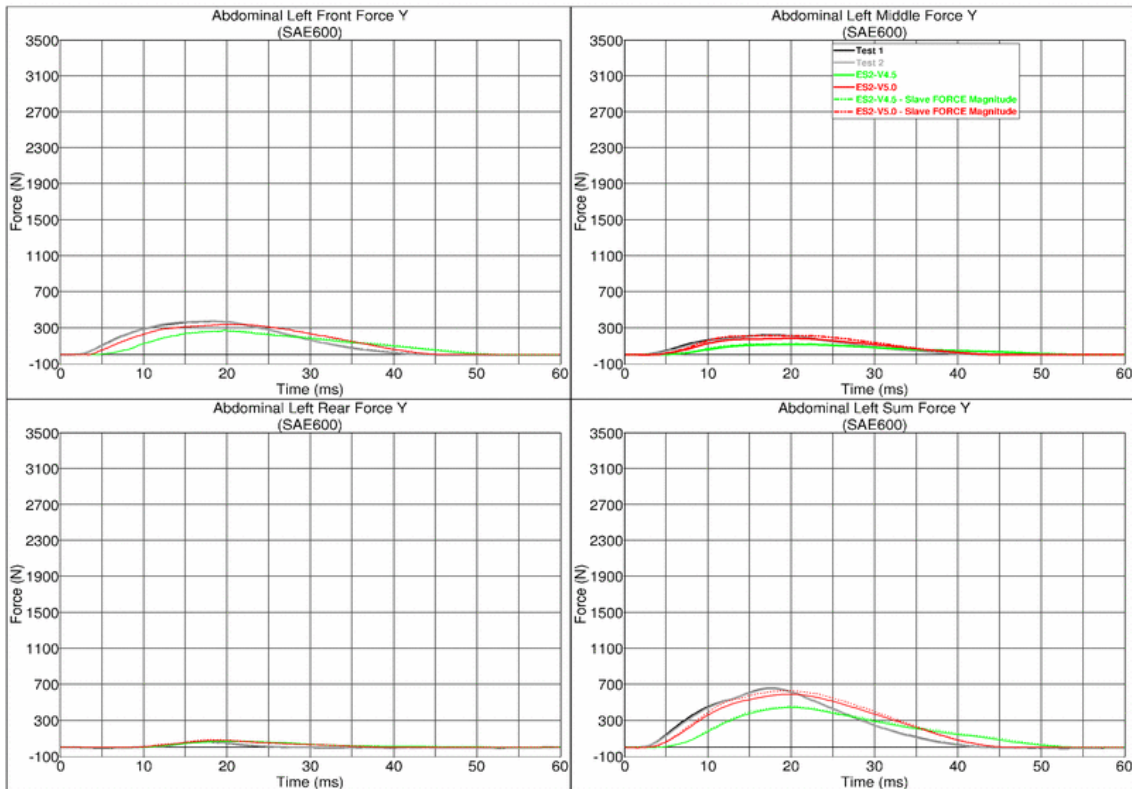

Results for 60° orientation, top impact, medium velocity

Abdomentest - 60 Grad, Top, Medium velocity

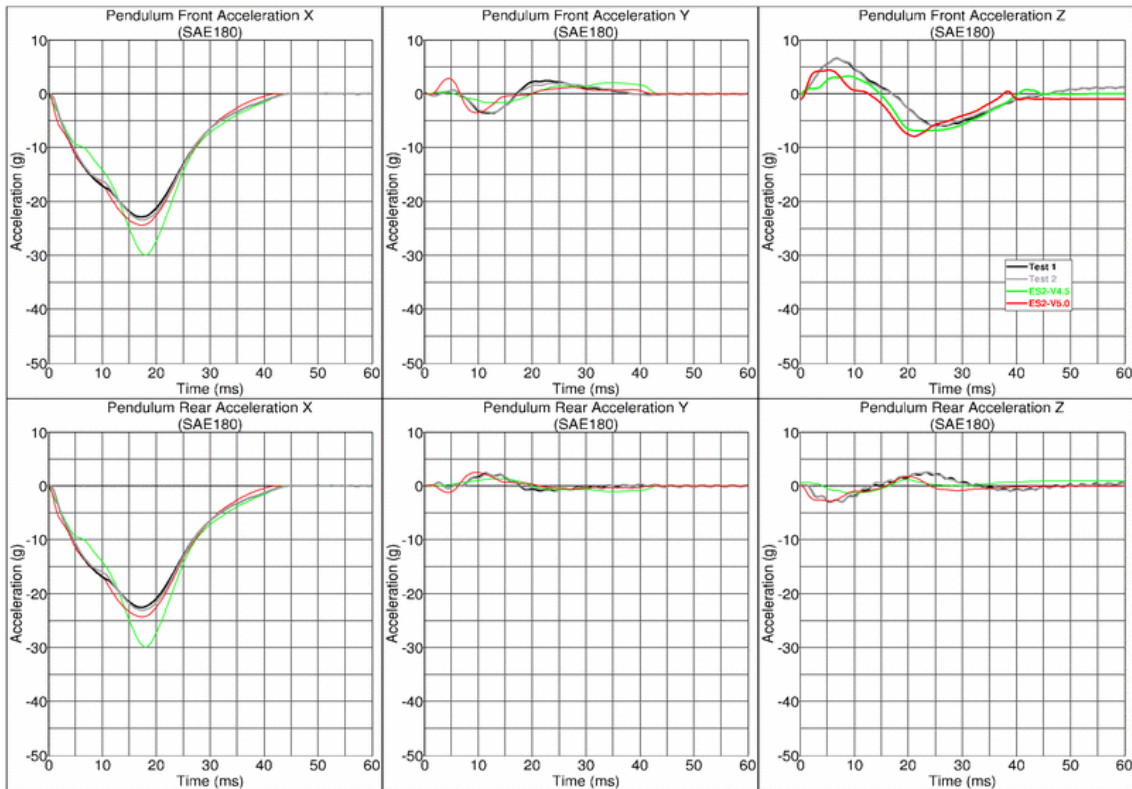

Abdomentest - 60 Grad, Top, Medium Velocity

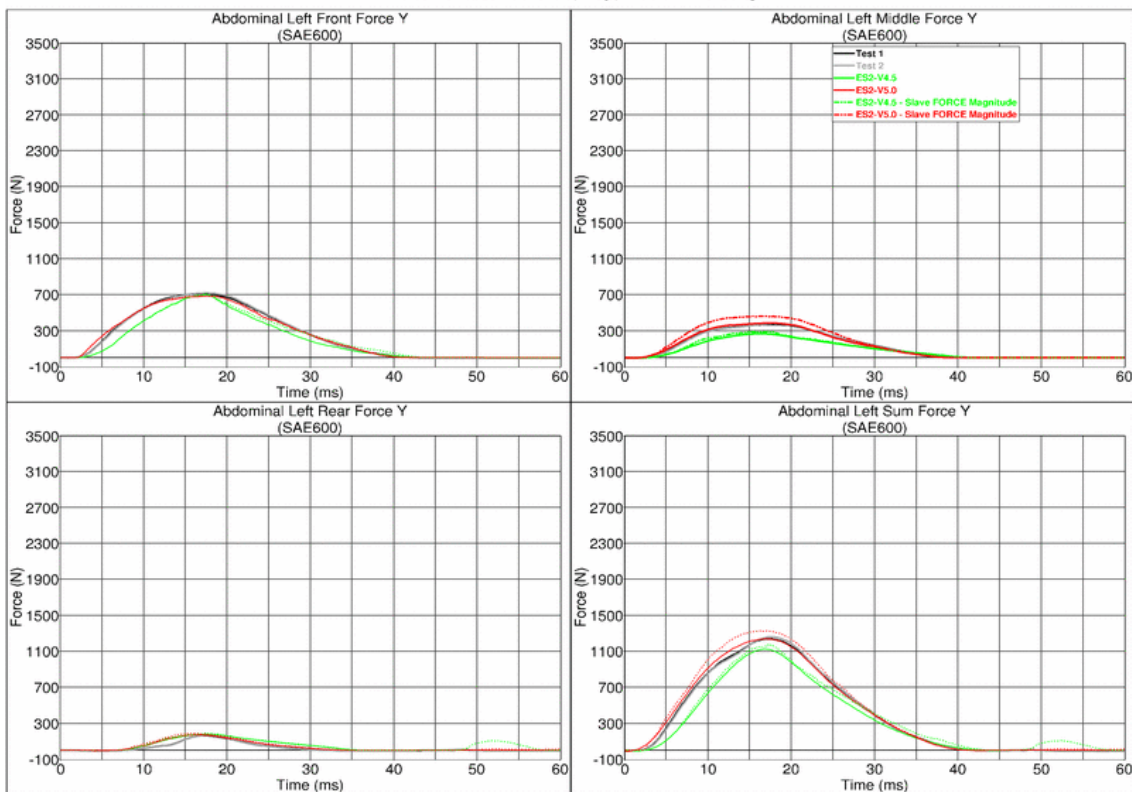

Results for 60° orientation, top impact, high velocity

Abdomentest - 60 Grad, Top, High velocity

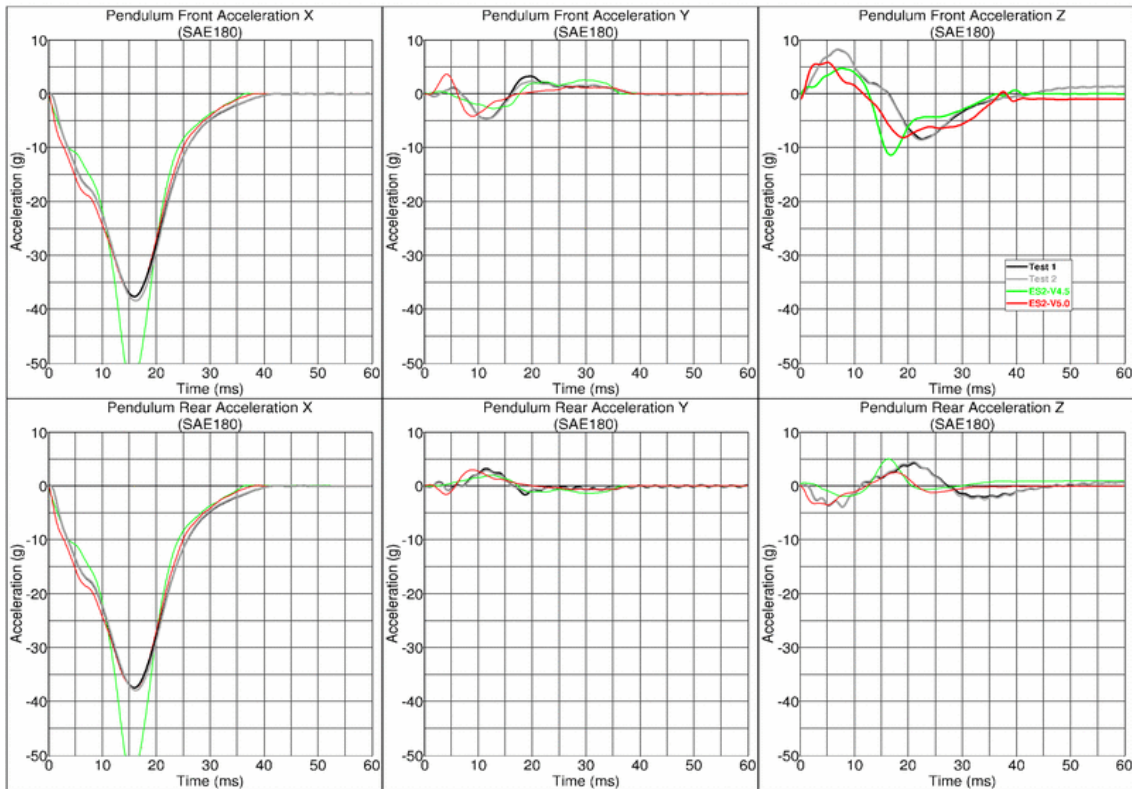

Abdomentest - 60 Grad, Top, High Velocity

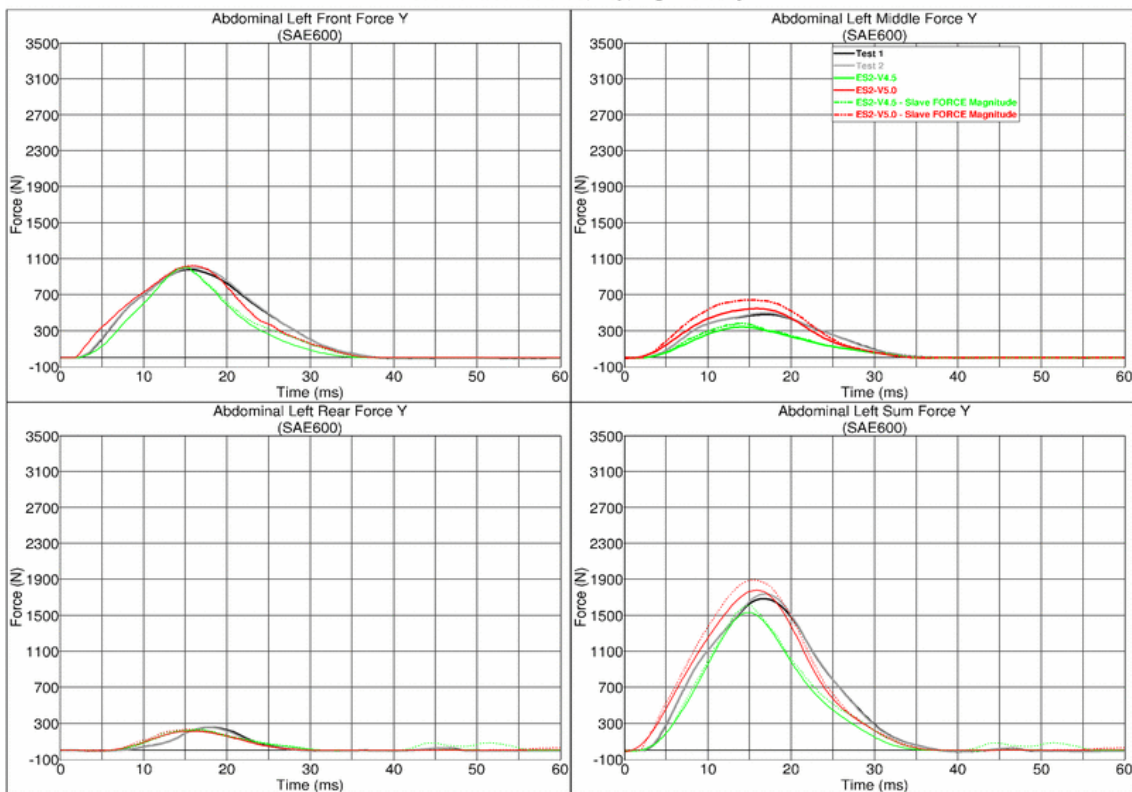

Results for 120° orientation, top impact, low velocity

Abdomentest - 120 Grad, Top, Low velocity

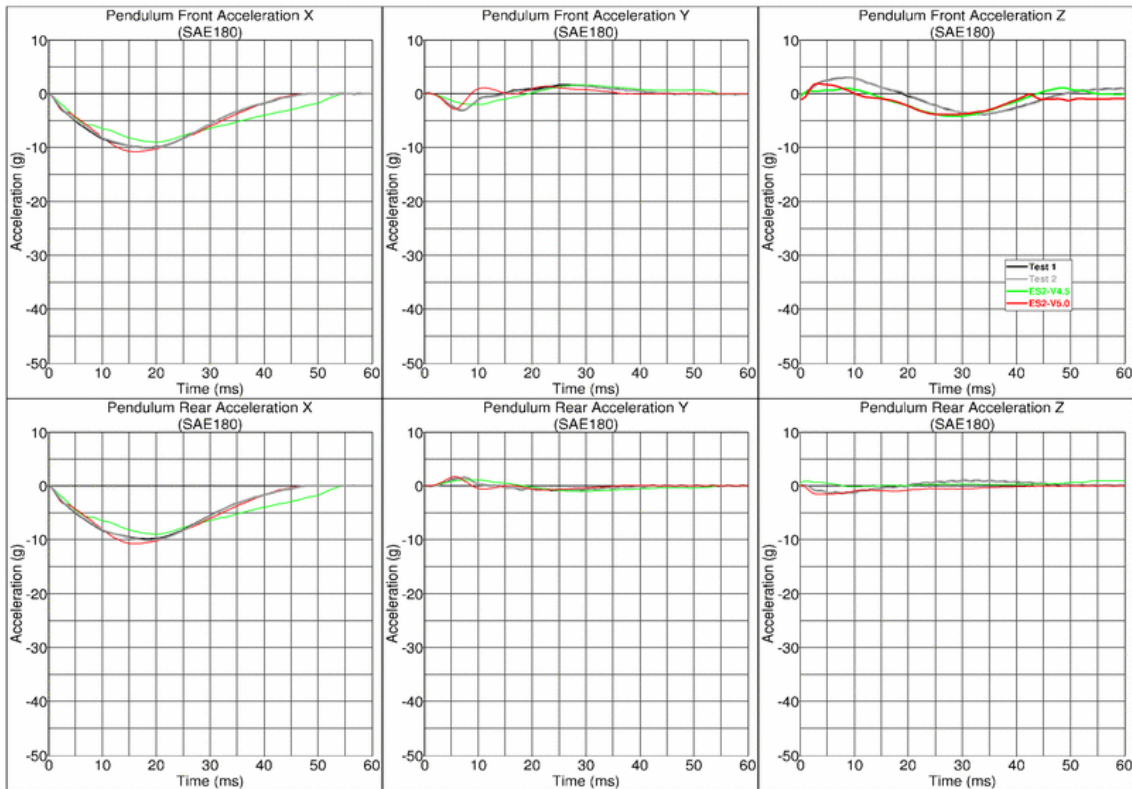

Abdomentest - 120 Grad, Top, Low Velocity

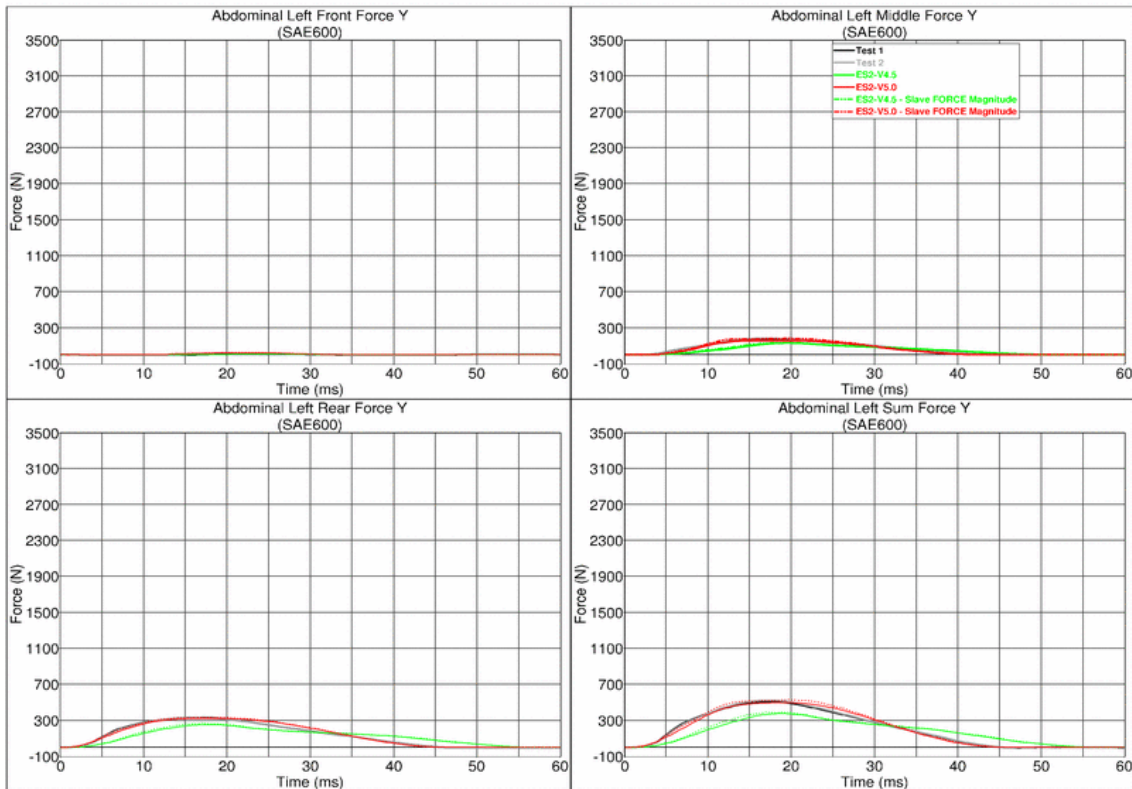

Results for 120° orientation, top impact, medium velocity

Abdomentest - 120 Grad, Top, Medium velocity

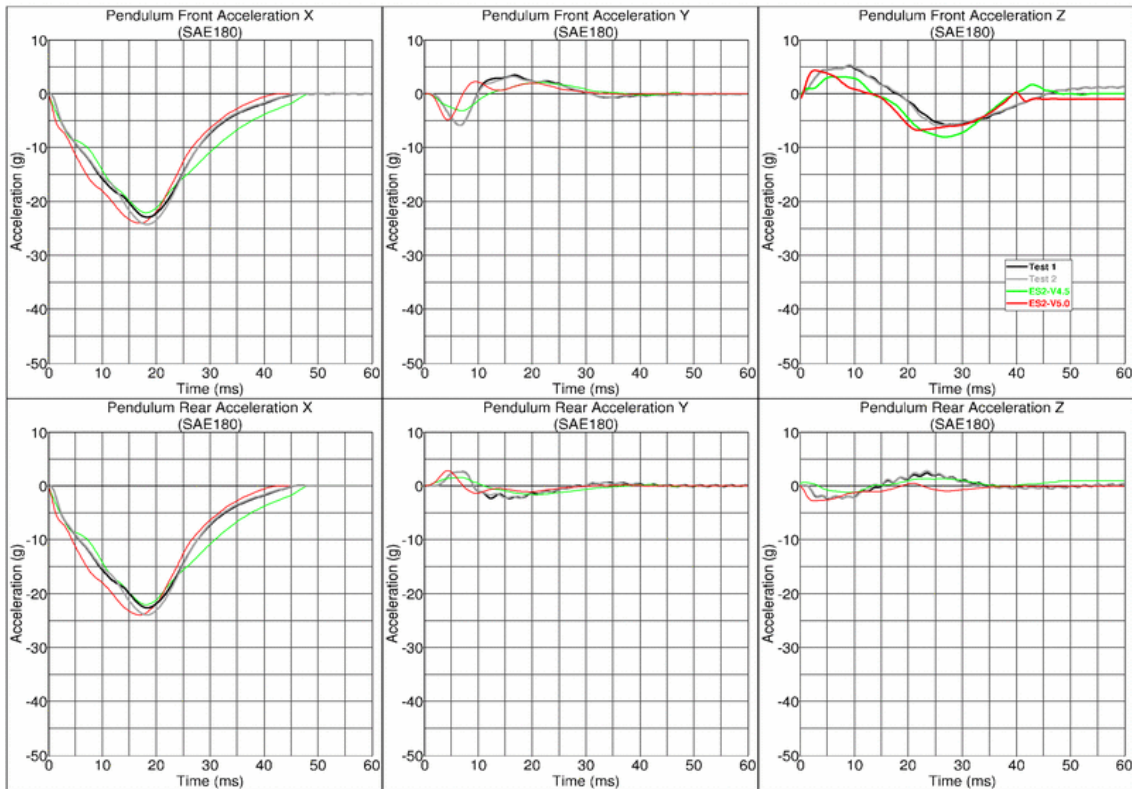

Abdomentest - 120 Grad, Top, Medium Velocity

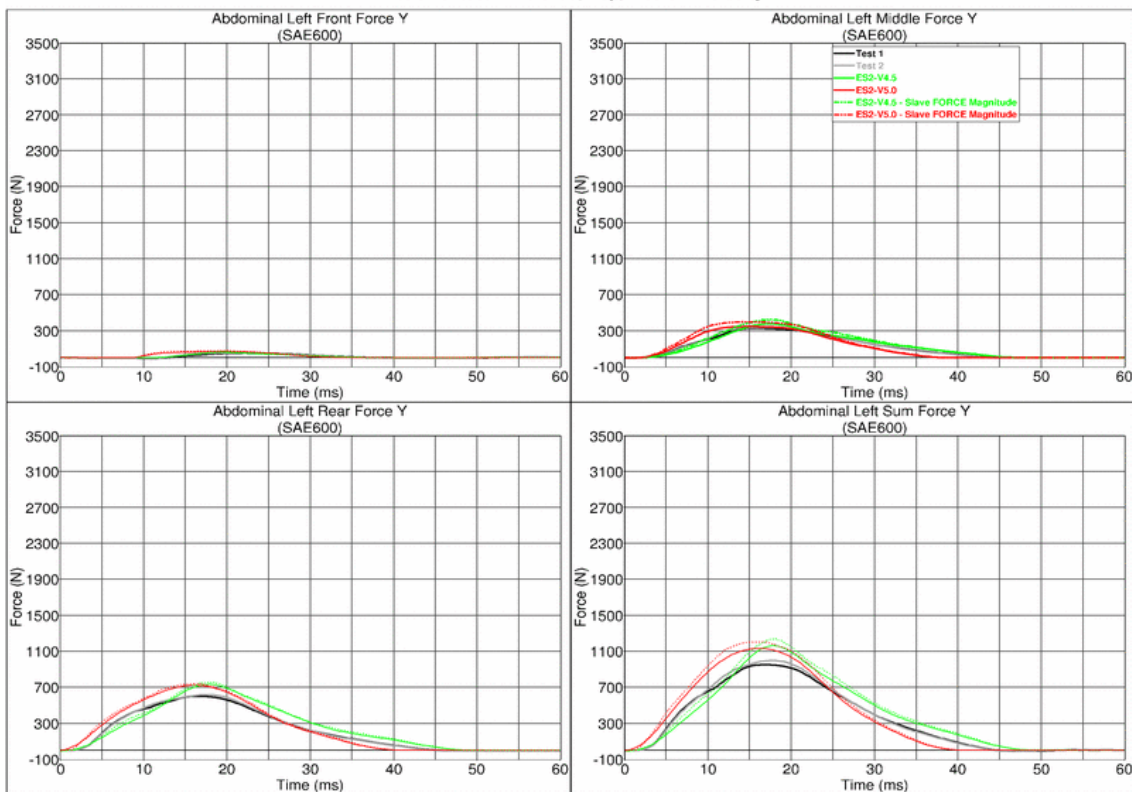

Results for 120° orientation, top impact, high velocity

Abdomentest - 120 Grad, Top, High velocity

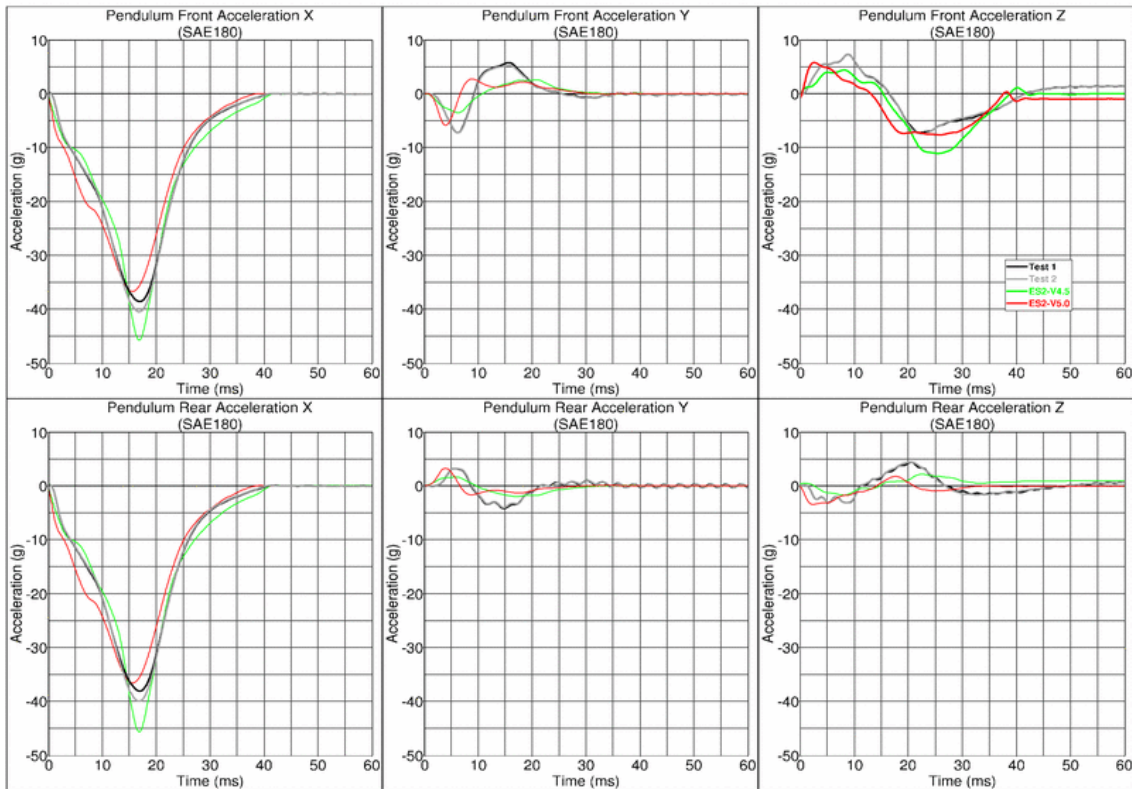

Abdomentest - 120 Grad, Top, High Velocity

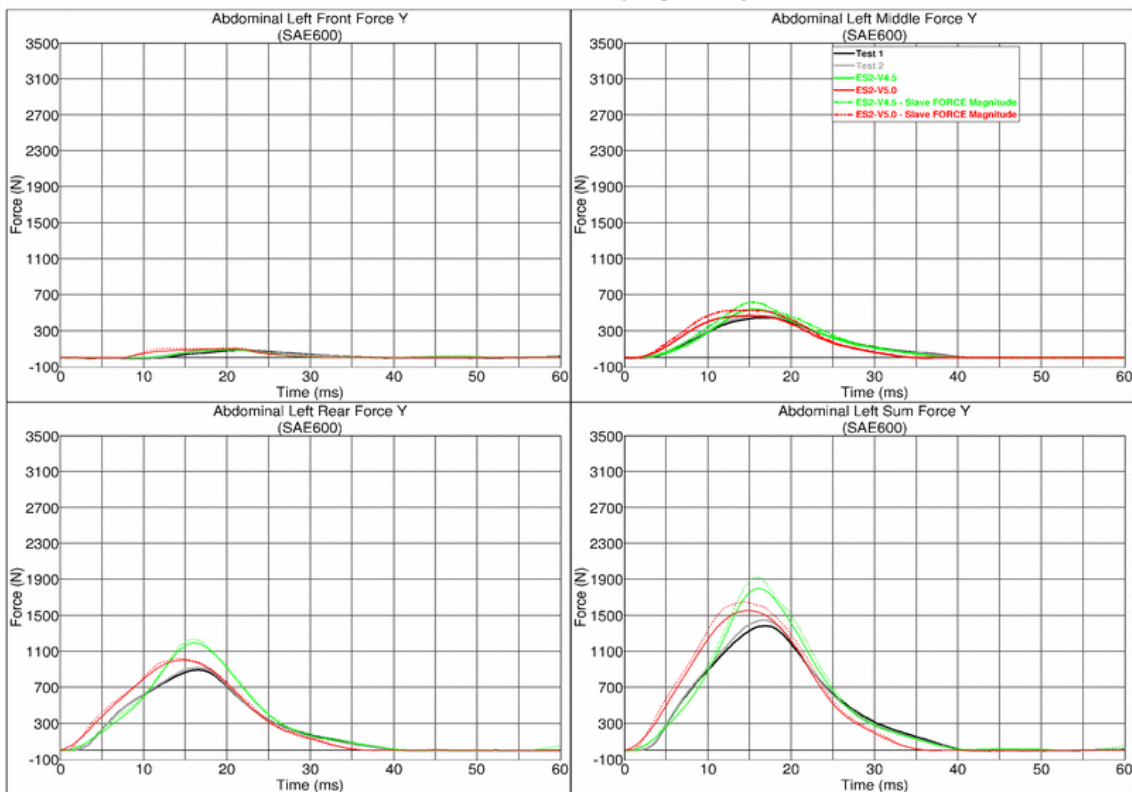

9.1.6 Lumbar spine test

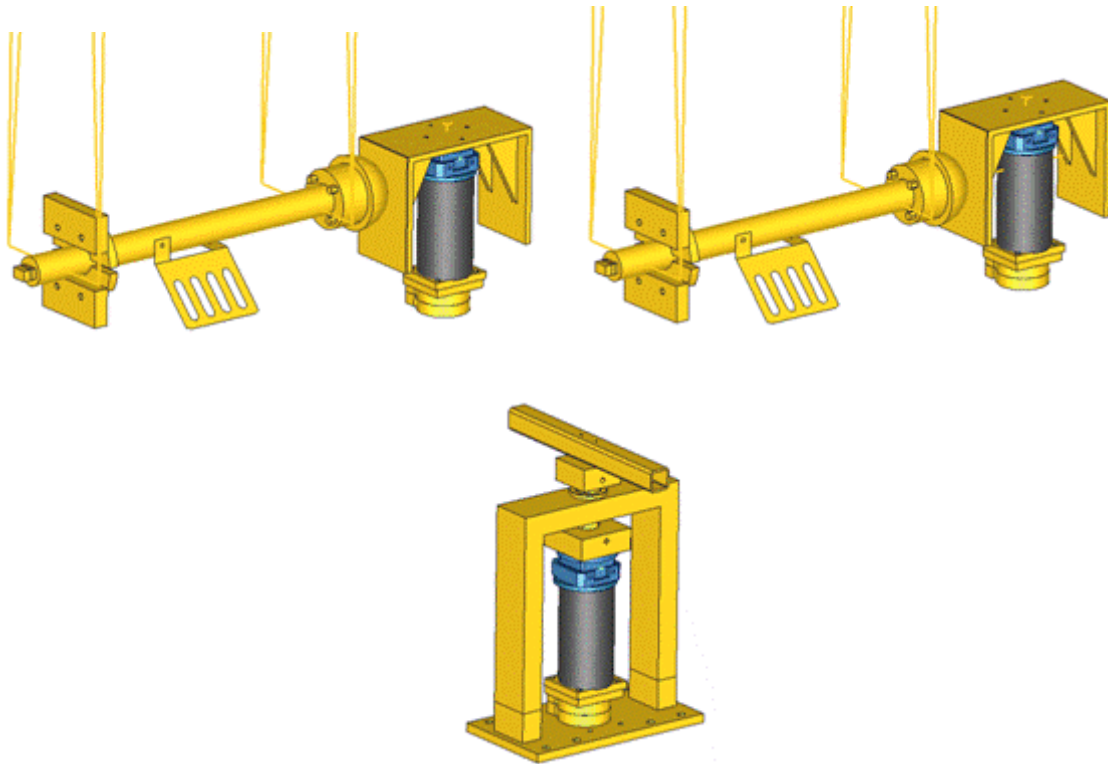

Figure 30: Setups for bending, shear and torsion tests on lumbar spine

The T12 load cell in the lumbar spine has been remodeled. A new spherical joint has been modeled at the bottom of the lumbar spine. Materials for the lumbar spine are from the EMI material tests. The test setups for bending, shear and torsion tests on the lumbar spine are shown in the figure above.

9.1.7 Iliac wing test

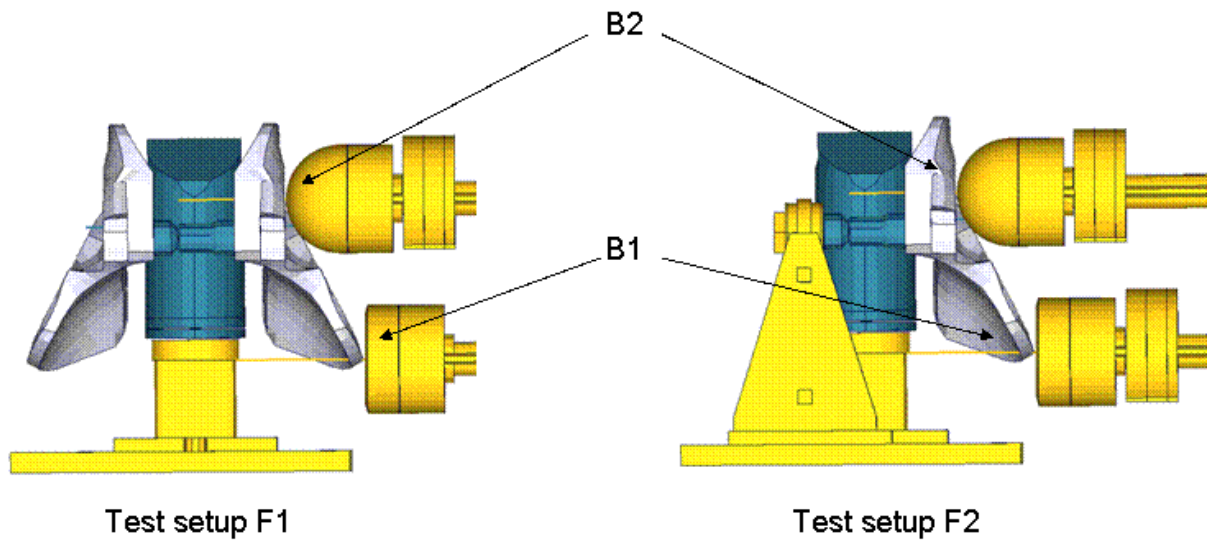
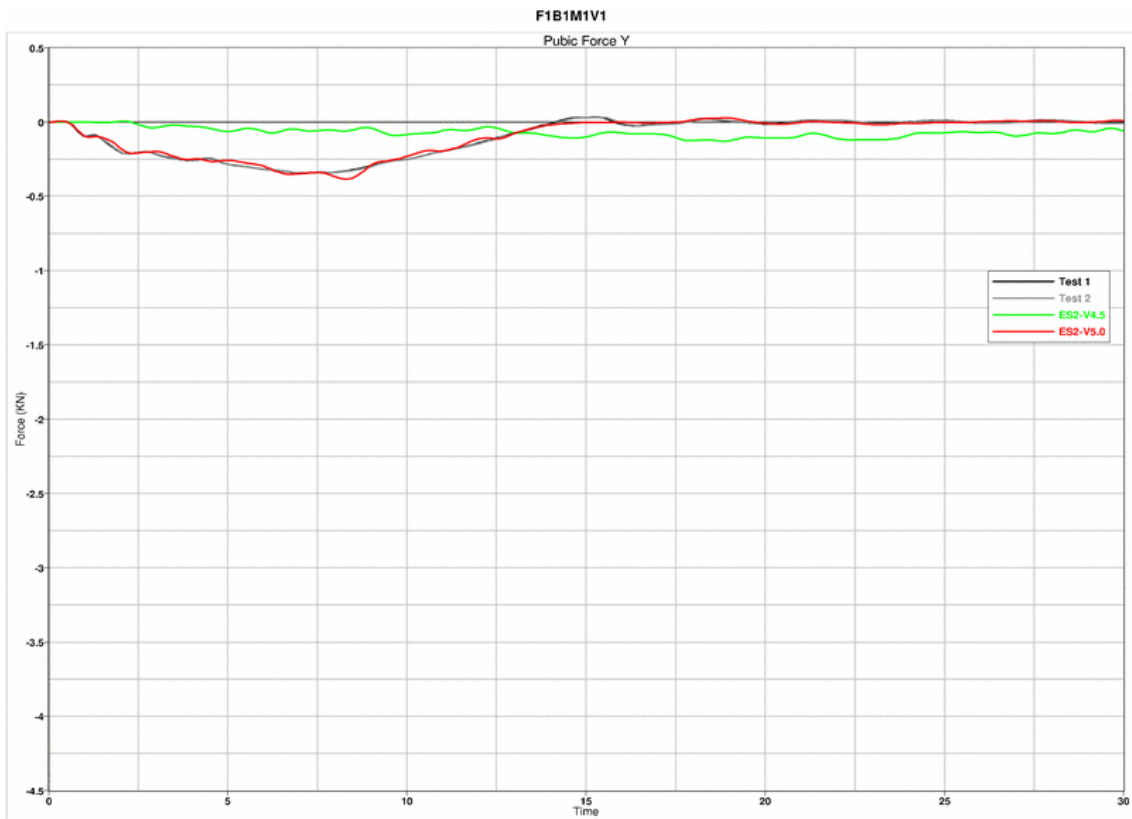
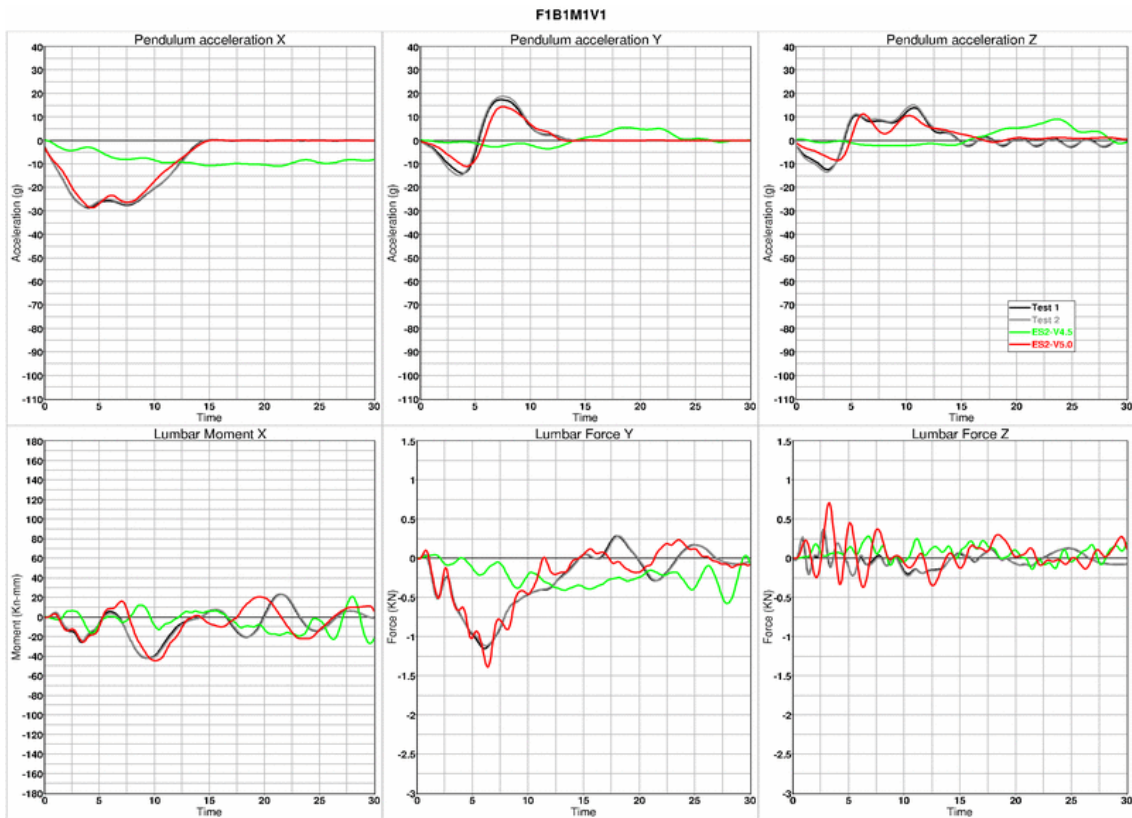

Figure 31: Test setup for Iliac wing test

The Iliac wing assembly is mounted on a test block as shown in the figure above. The Iliac wings are impacted by a hemispherical-headed pendulum and a cylindrical-headed pendulum at 2 different points as indicated in the figure. The pendulum masses are varied for different configurations and the test is carried out at 2 velocities.

Results for configuration F1B1M1 , low velocity



Results for configuration F1B1M1 , high velocity

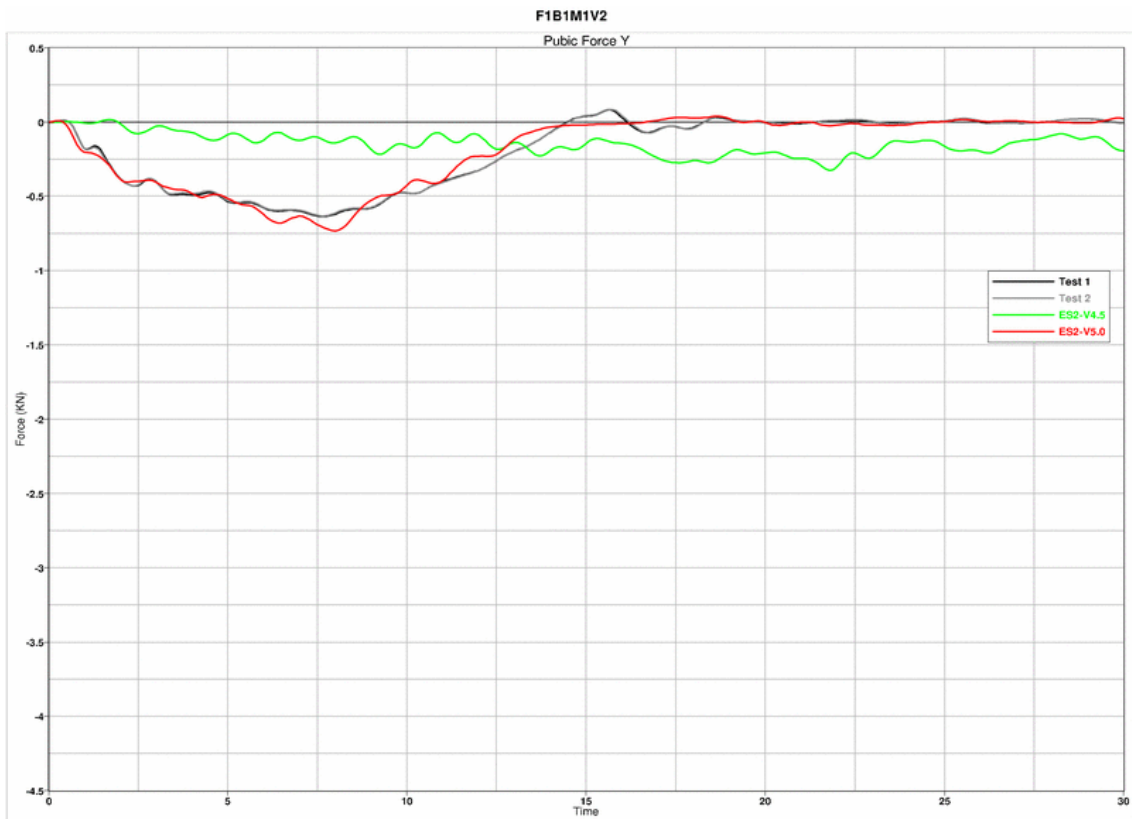
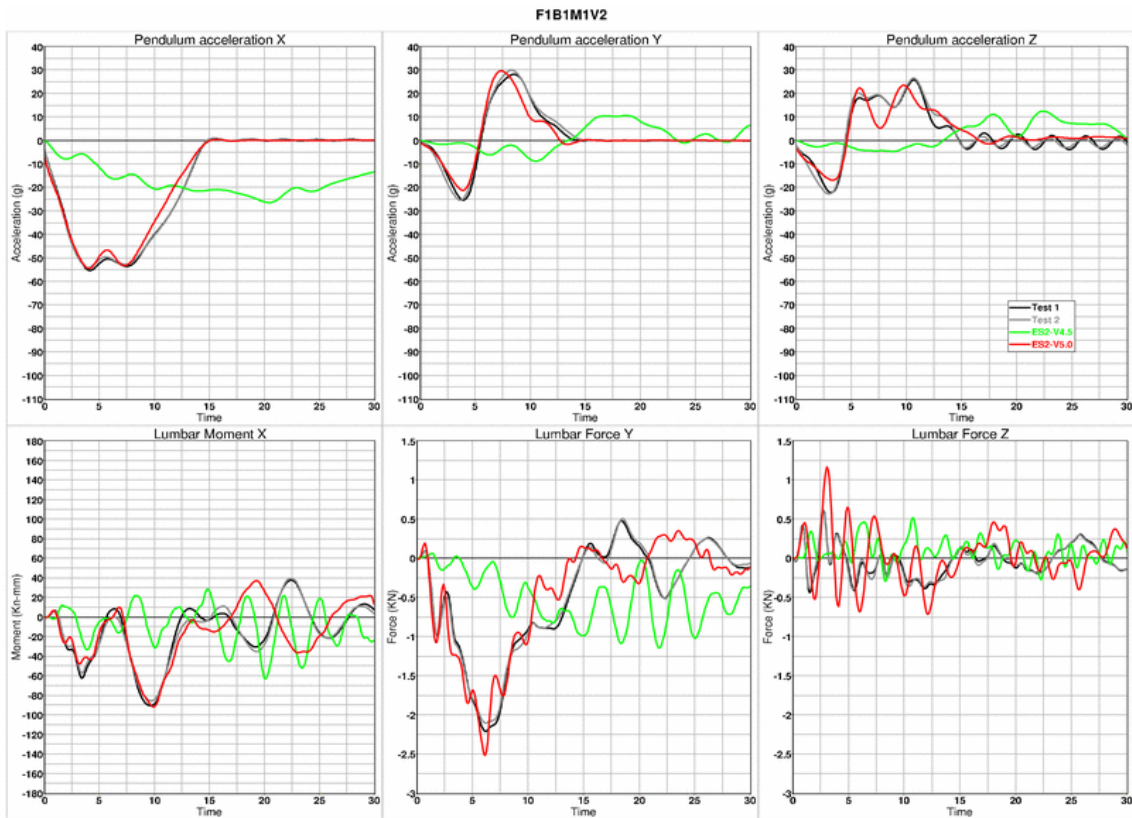

Results for configuration F1B2M1 , high velocity

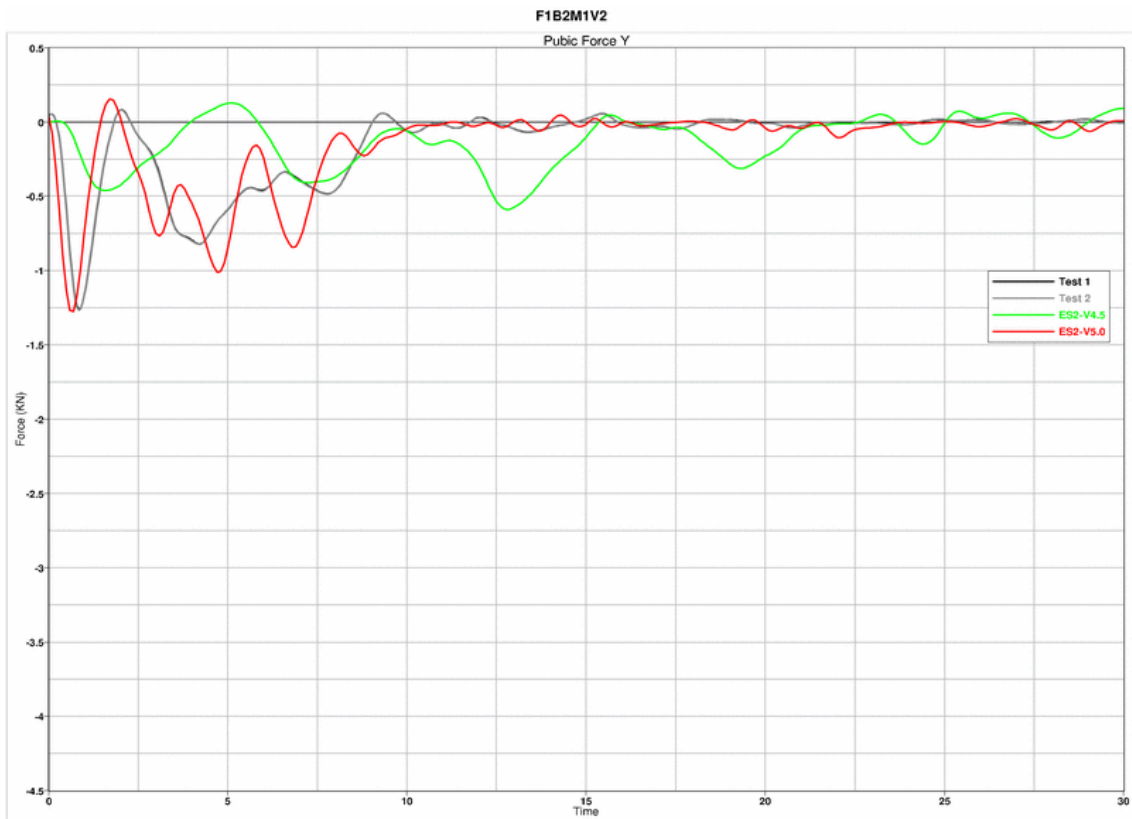
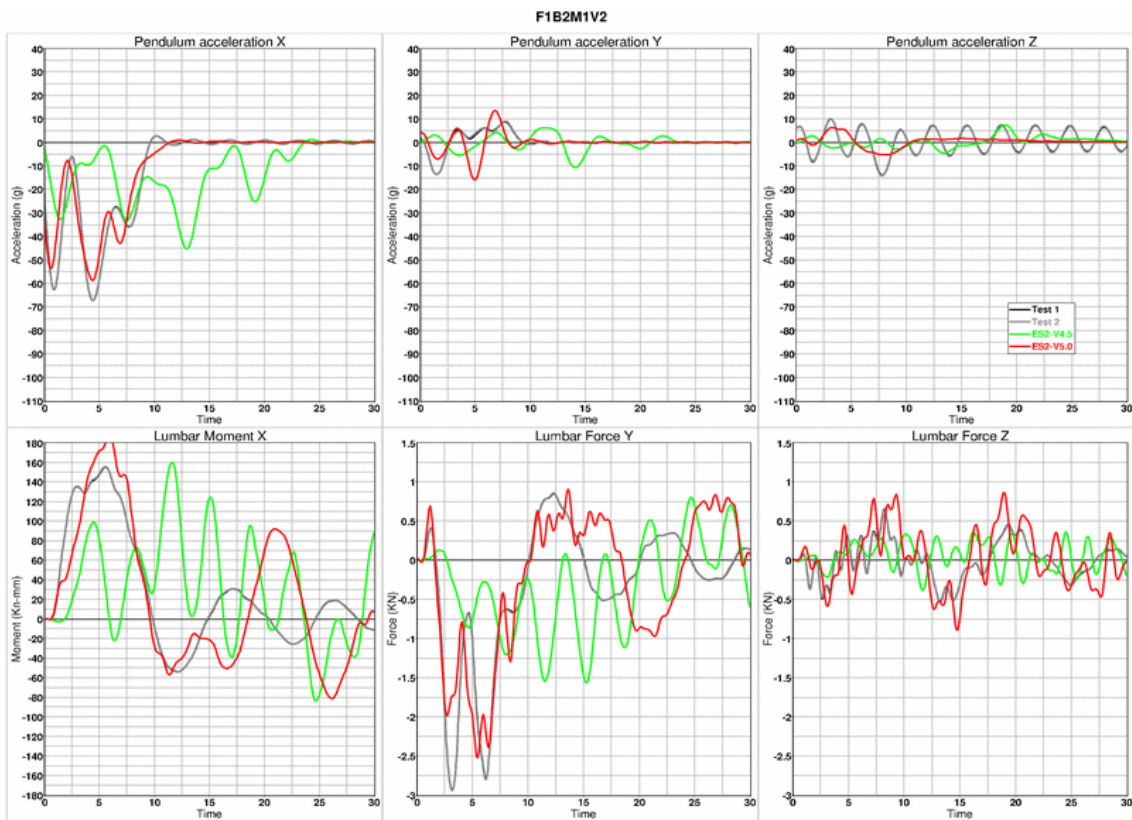

Results for configuration F1B2M2 , low velocity

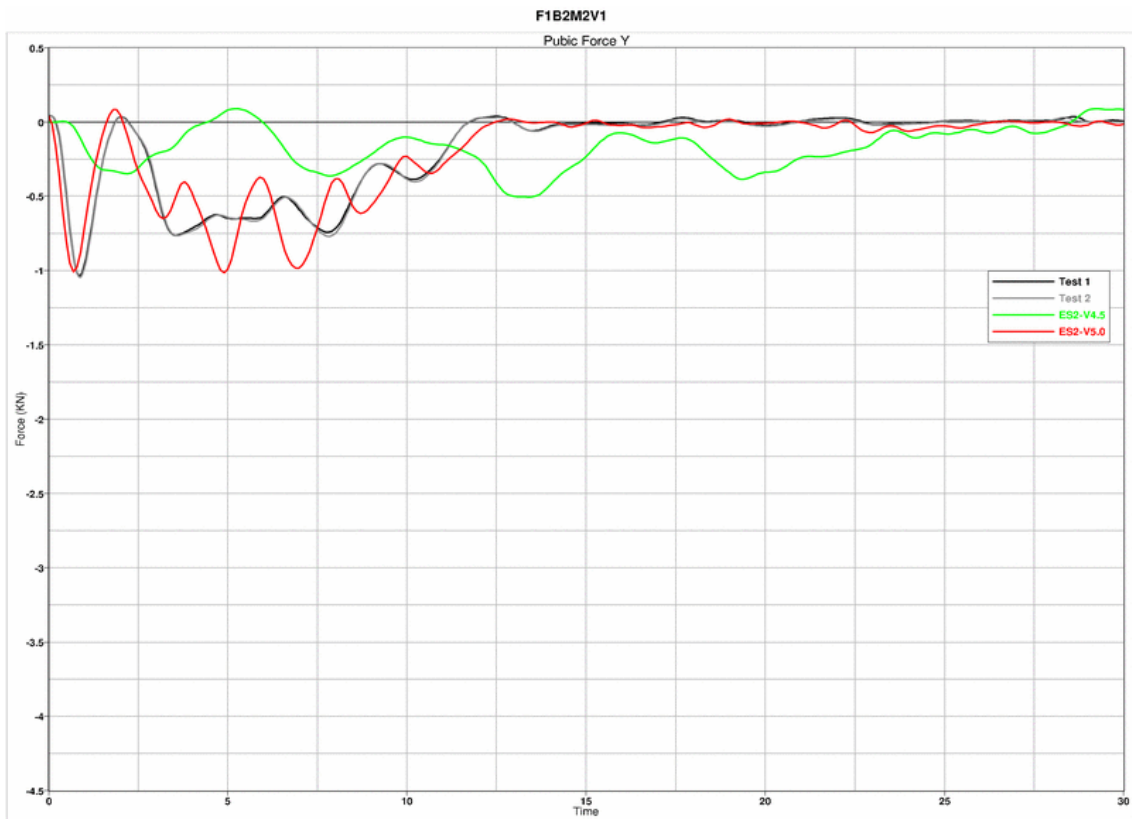
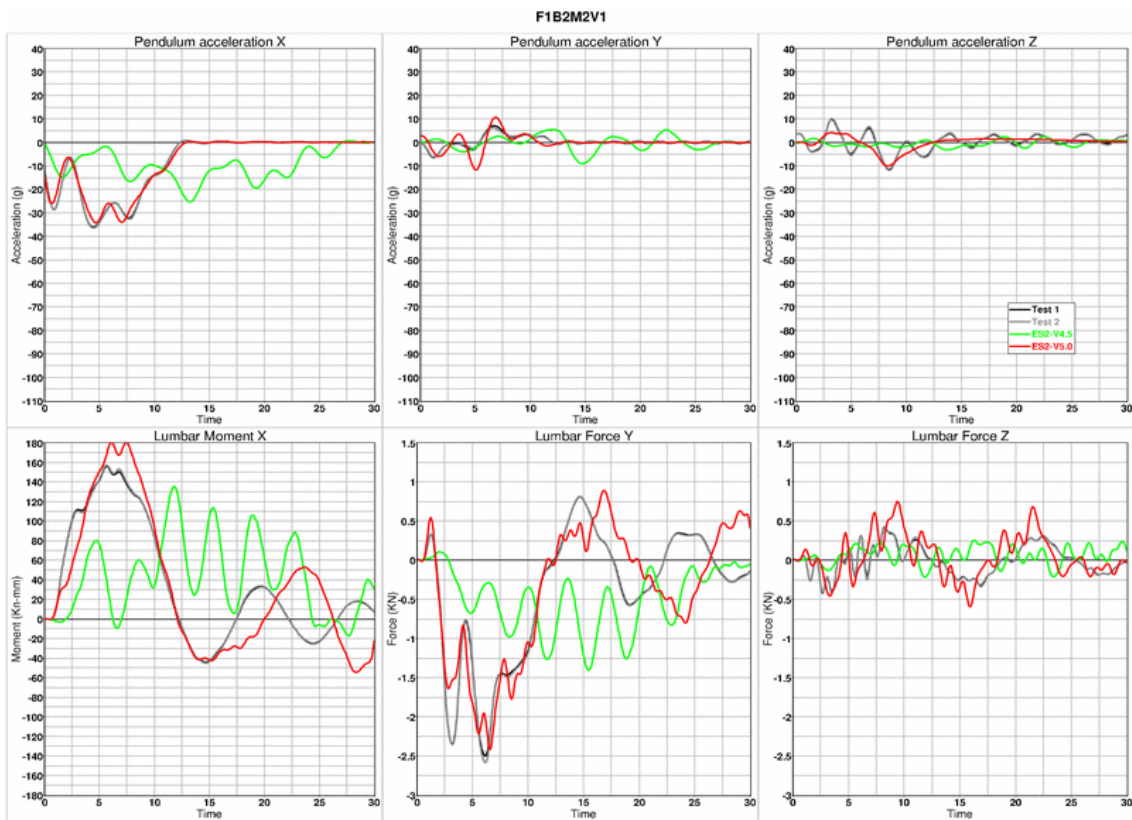

Results for configuration F2B1M2 , low velocity

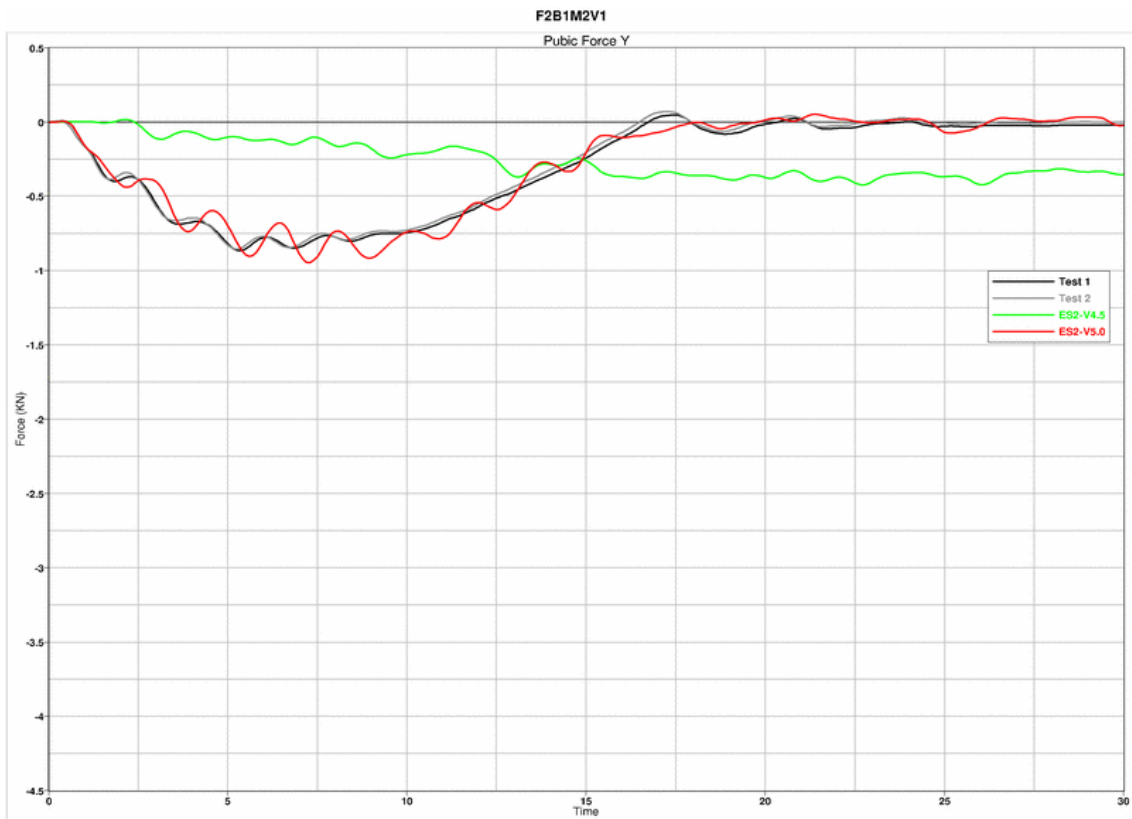
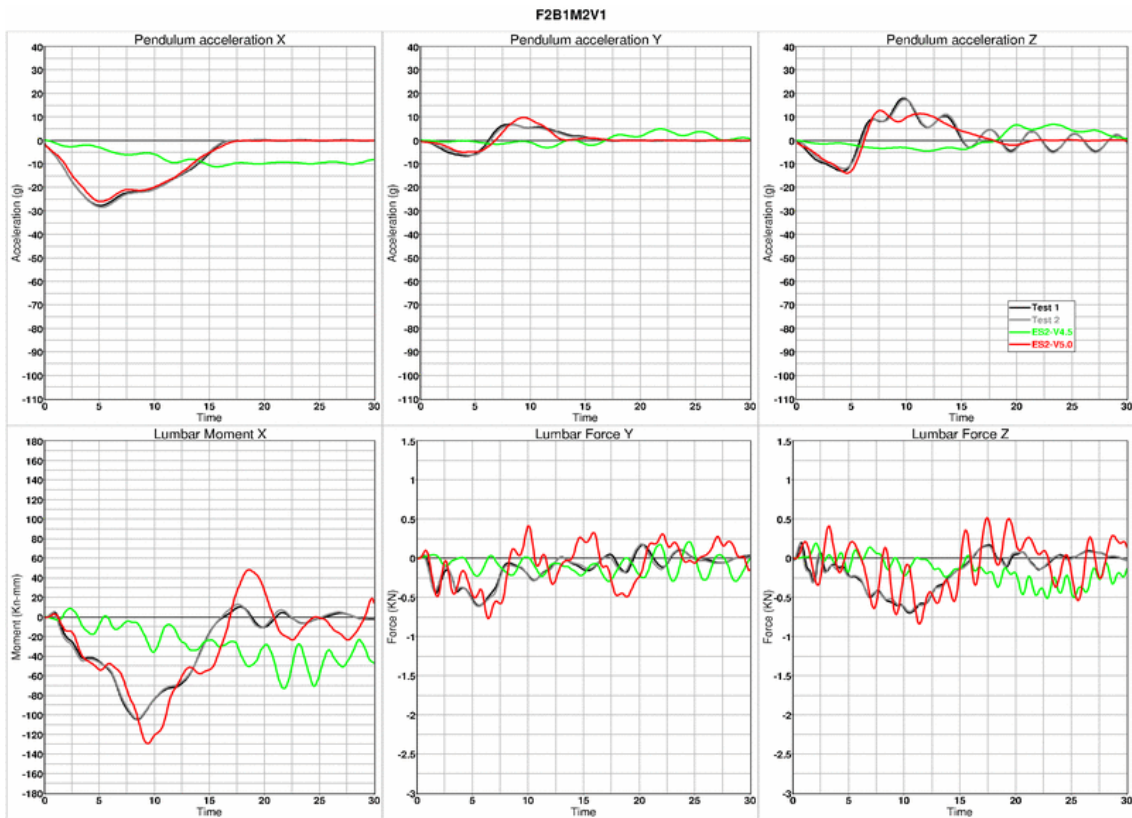

Results for configuration F2B1M2 , high velocity

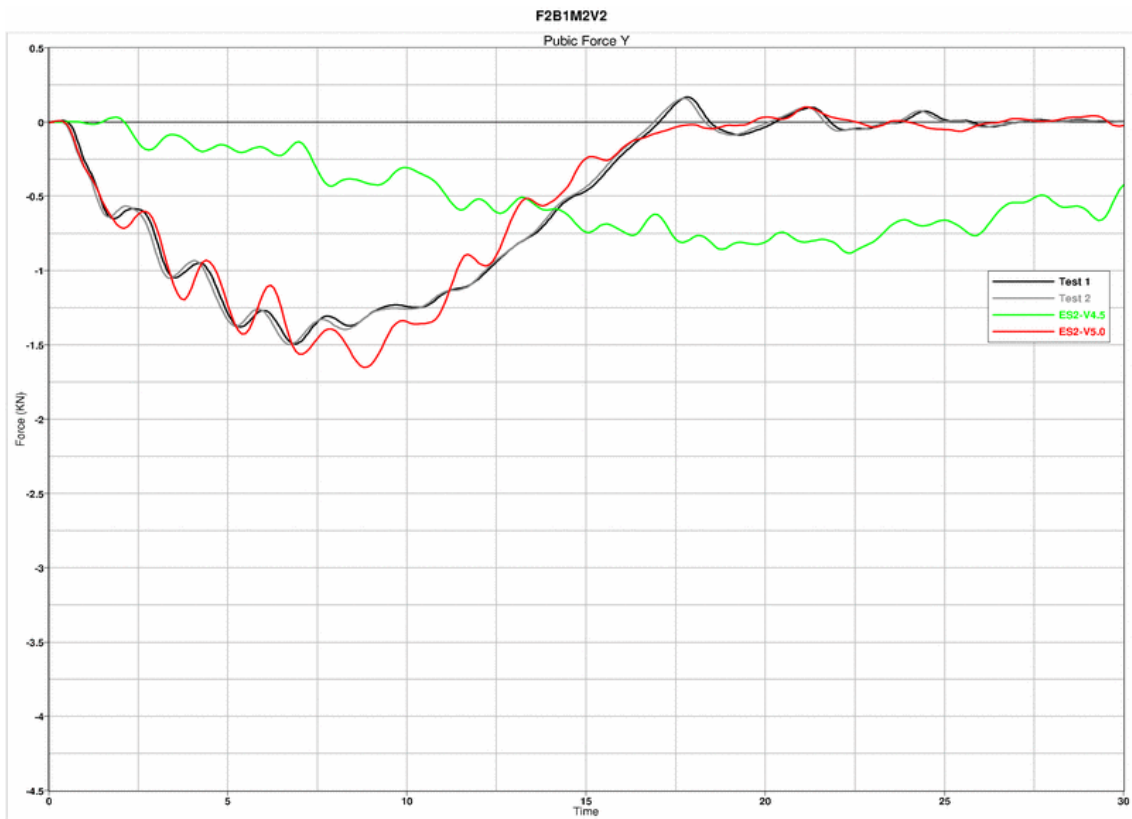
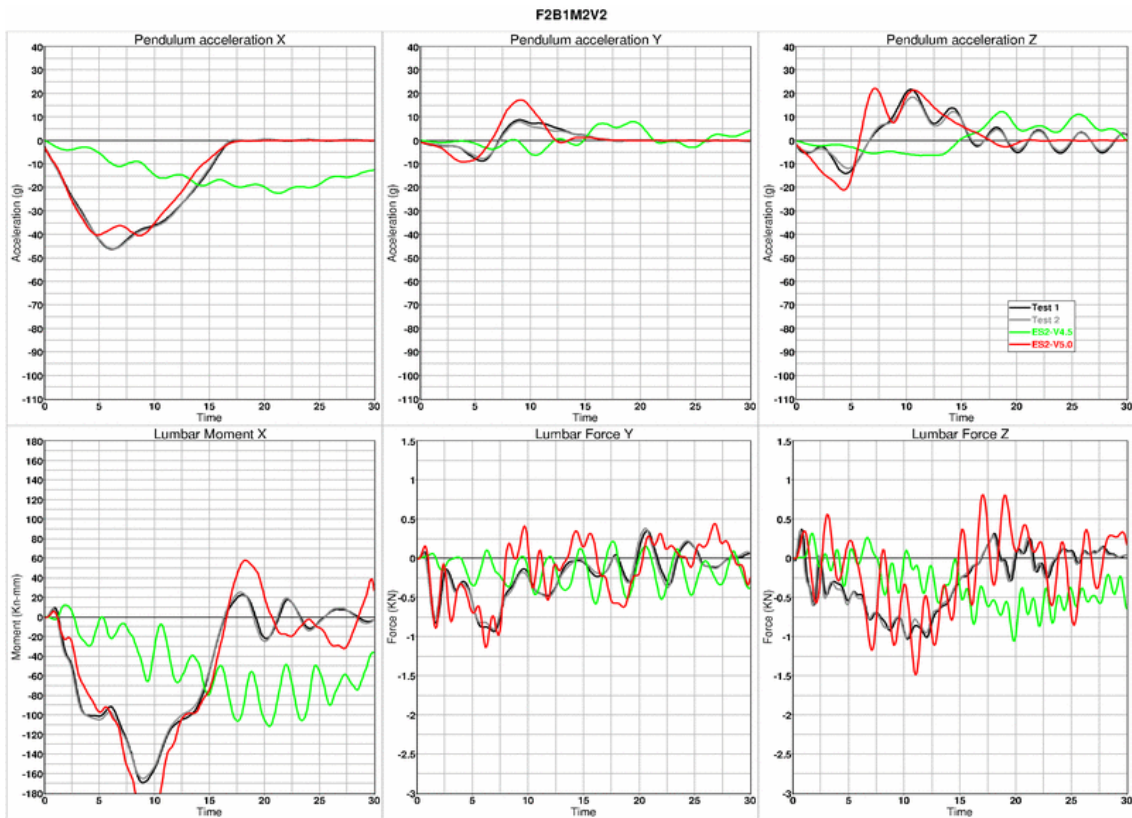

Results for configuration F2B2M2 , low velocity

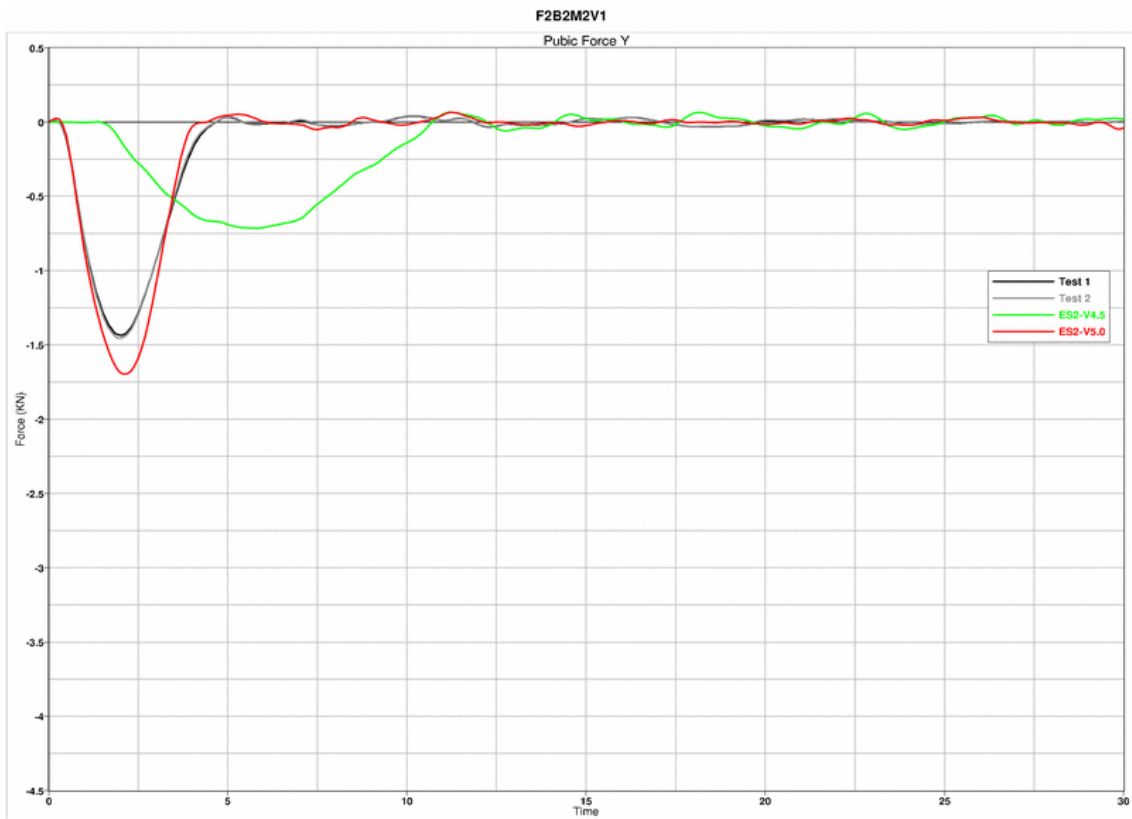
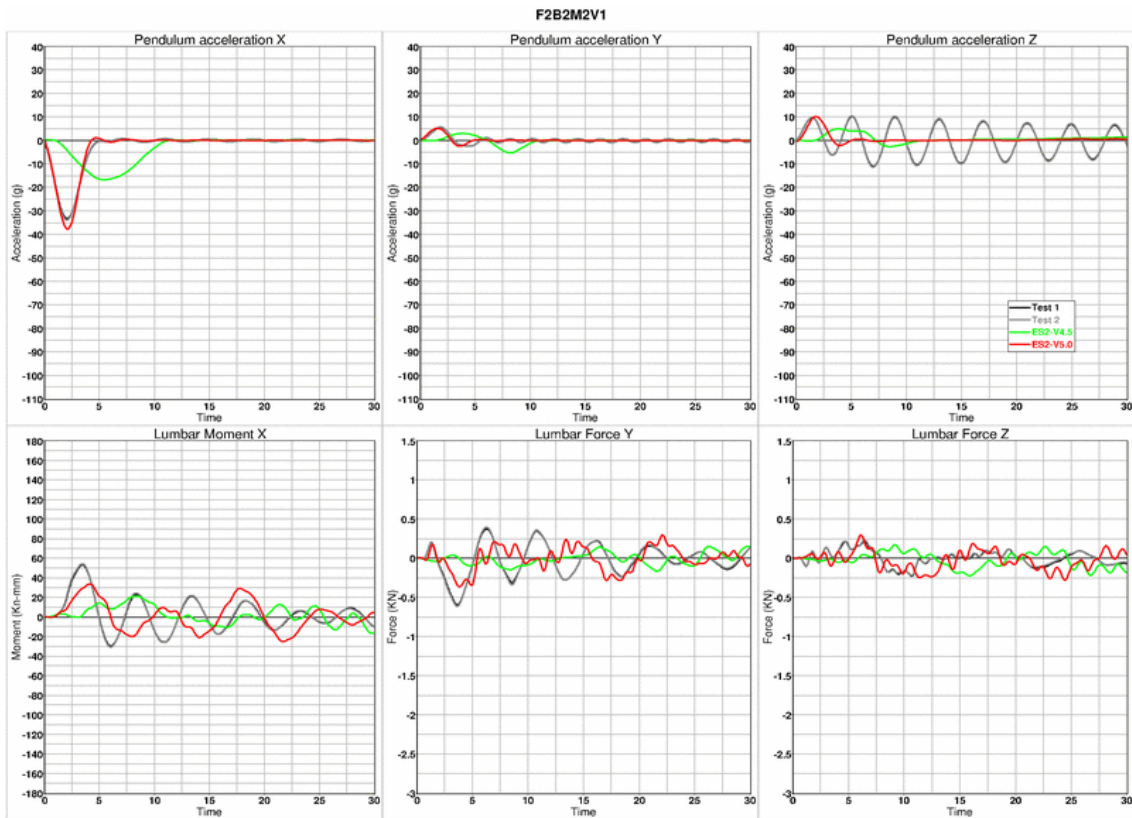

Results for configuration F2B2M2 , high velocity

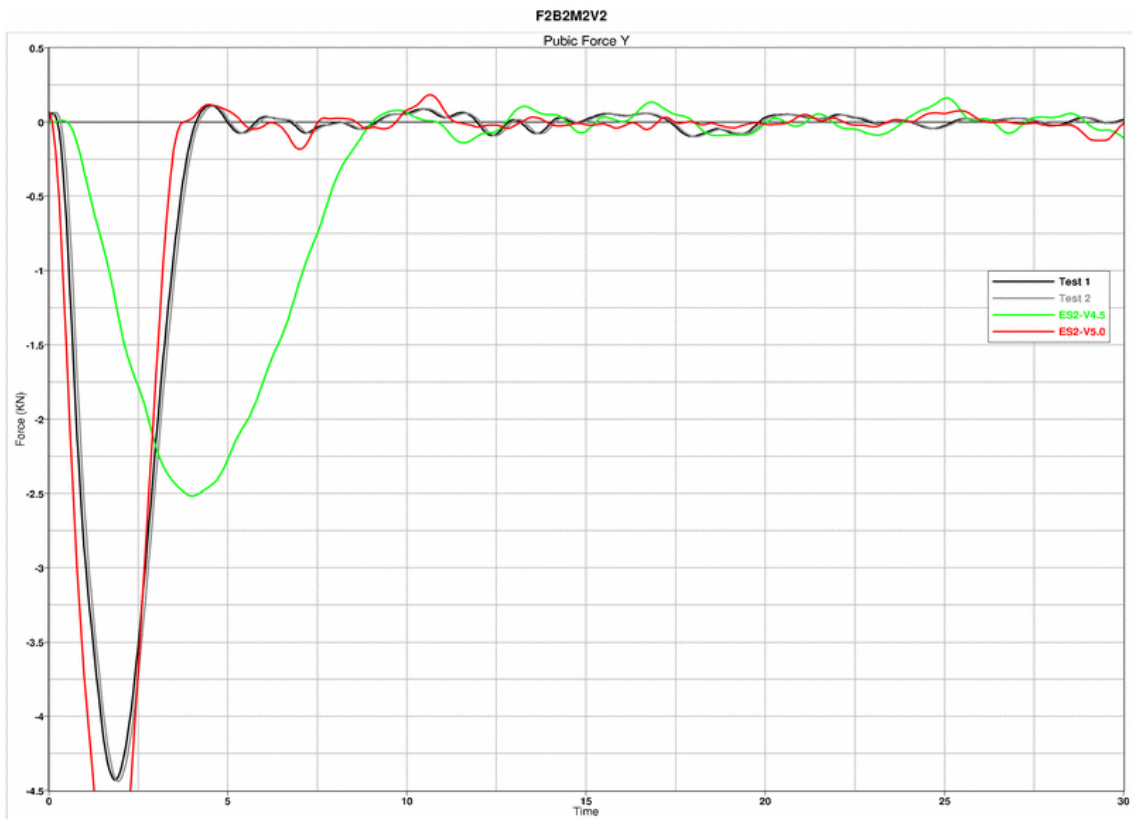
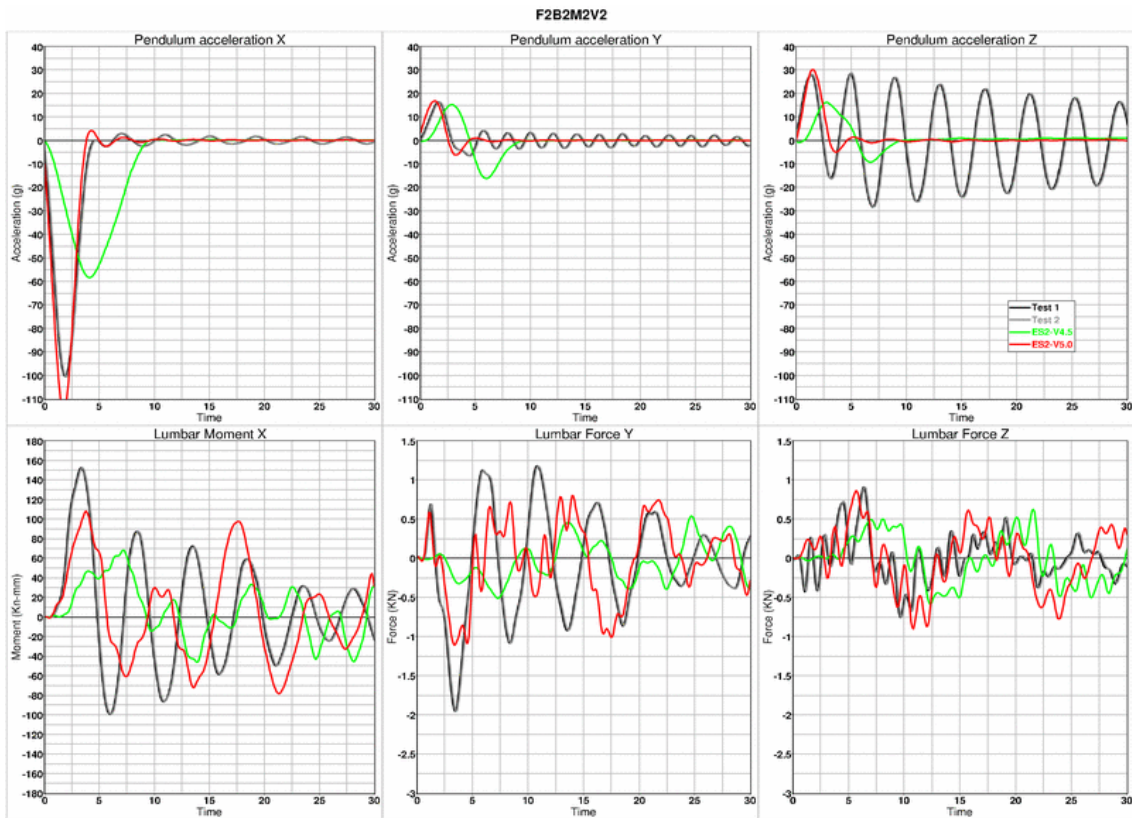

9.2 Rib module tests

9.2.1 Test setup 1

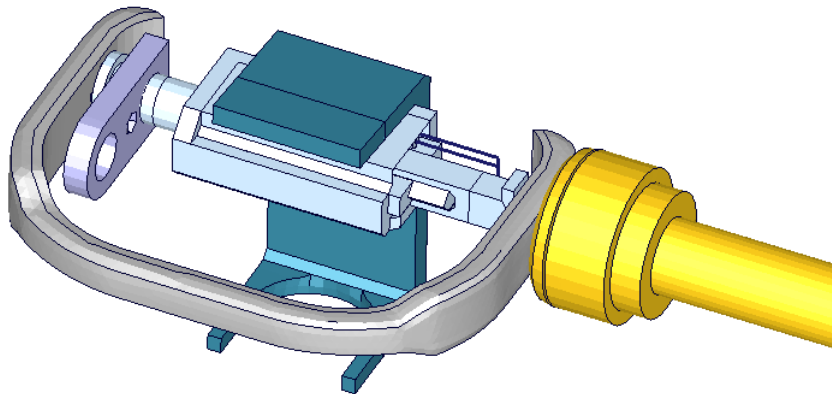
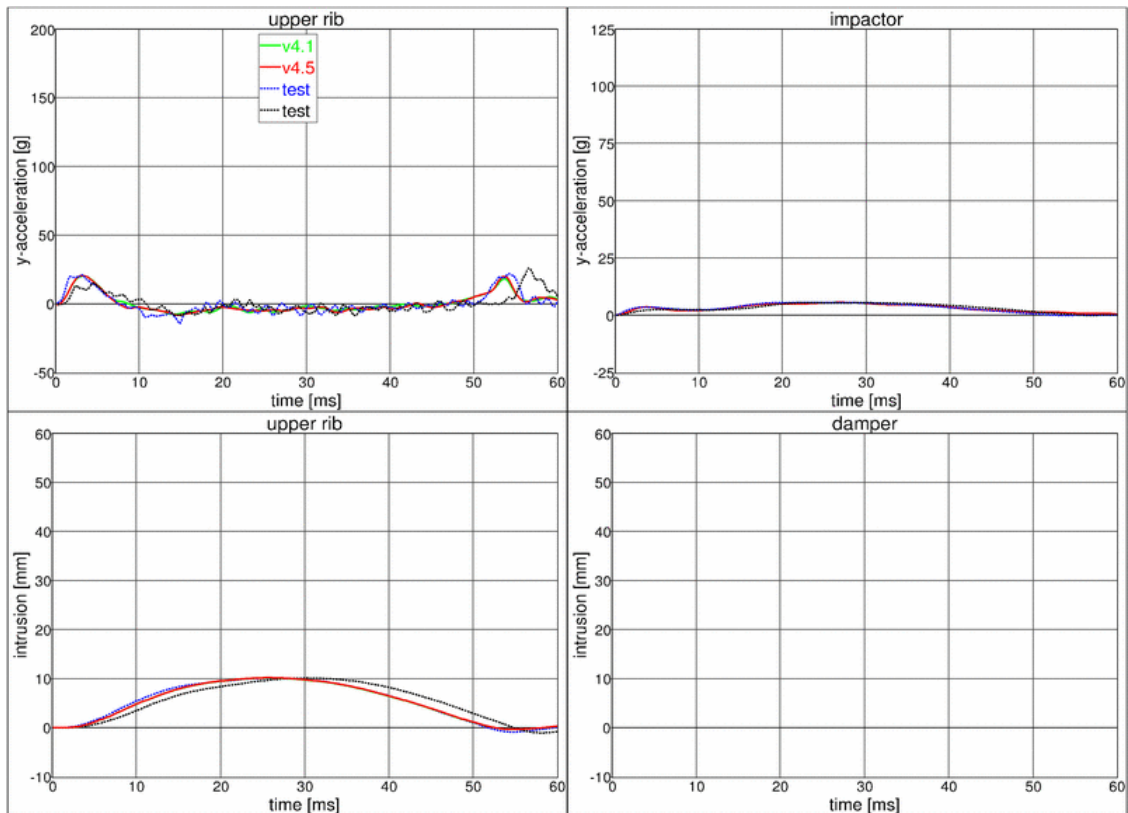

Figure 32: ES-2 rib module test setup 1

- Pendulum impacting the assembly at the rib guidance
- 5 impact velocities
- Damper assembly is removed

9.2.2 Test setup 1: velocity 1



9.2.3 Test setup 1: velocity 2

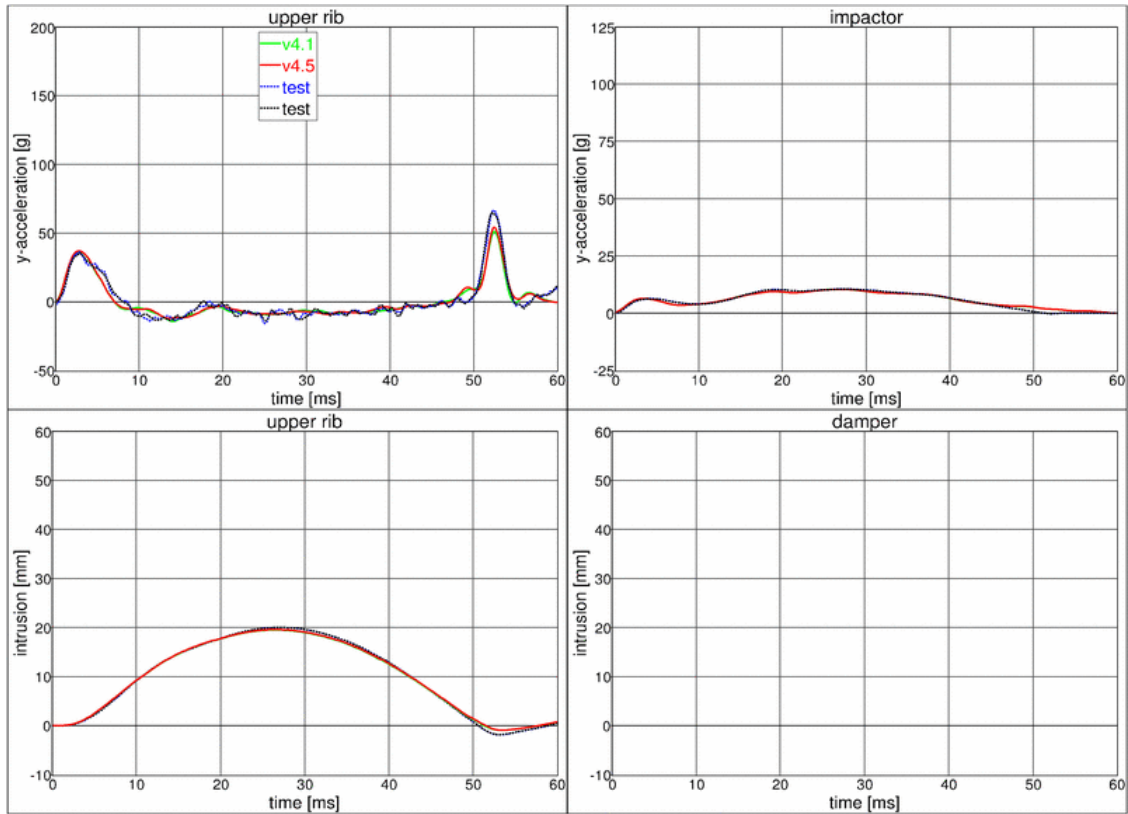

9.2.4 Test setup 1: velocity 3

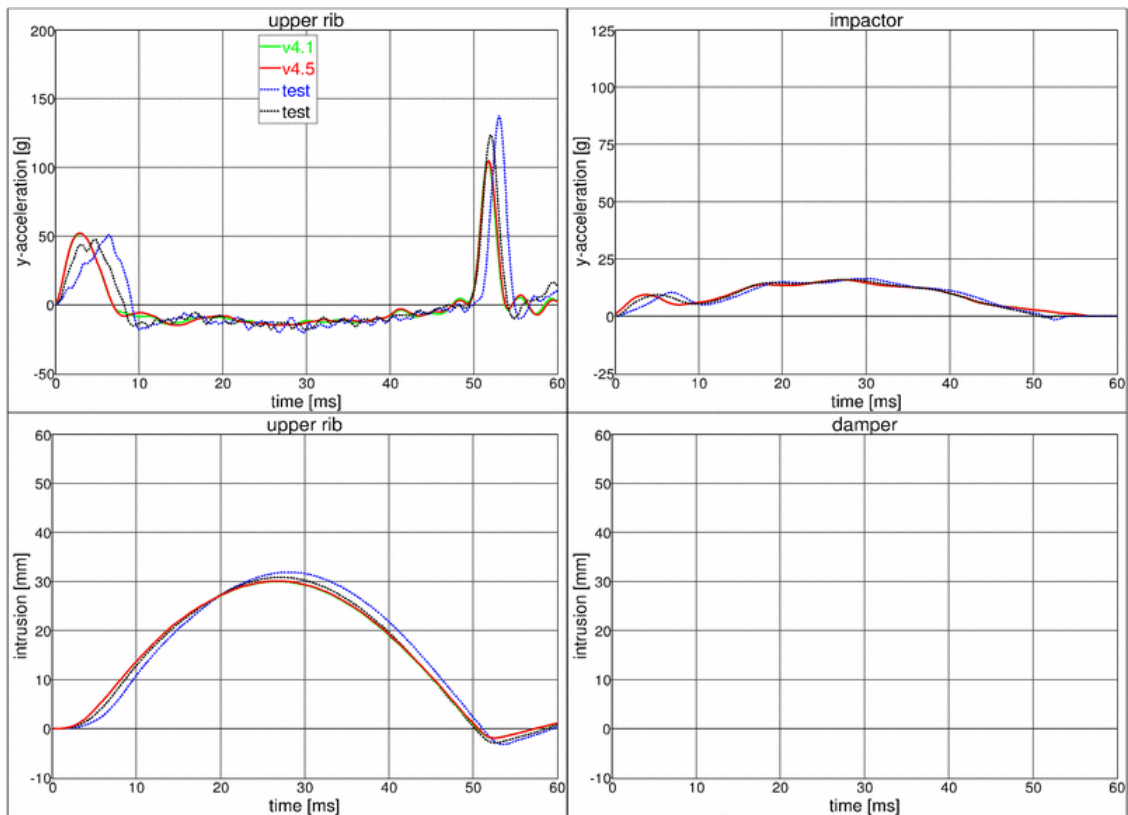

9.2.5 Test setup 1: velocity 4

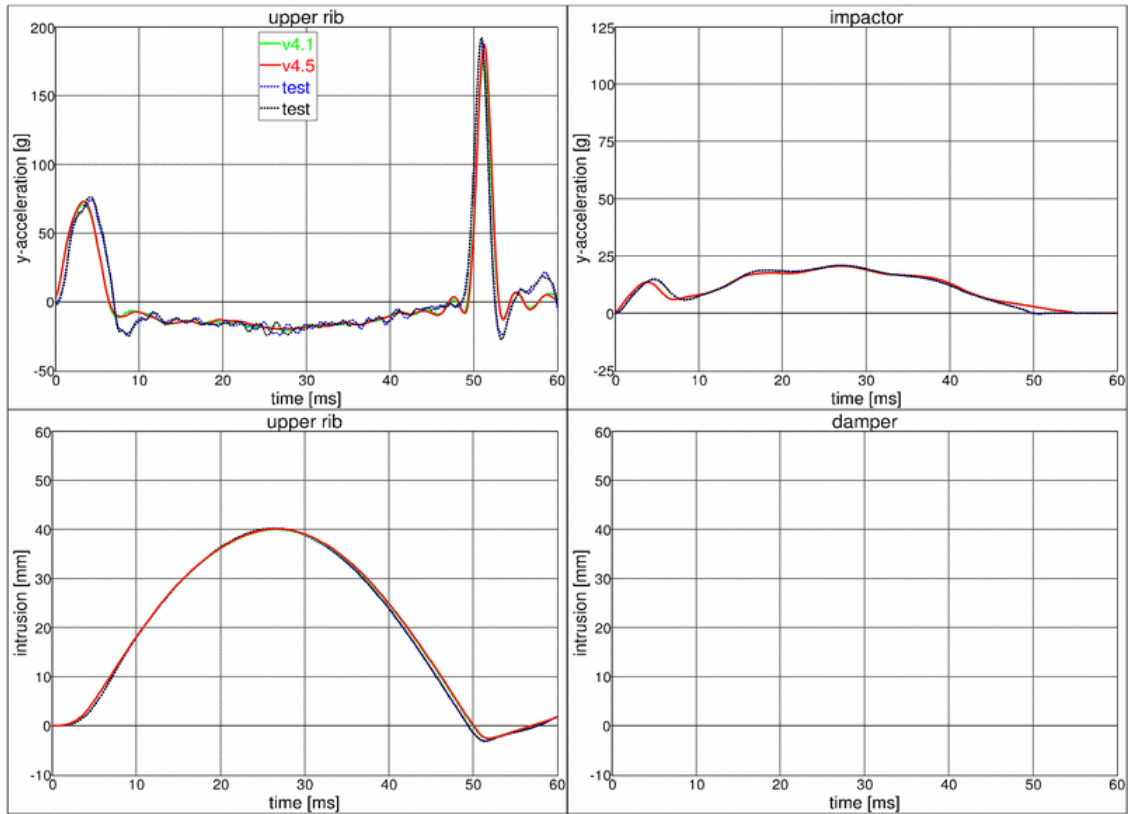

9.2.6 Test setup 1: velocity 5

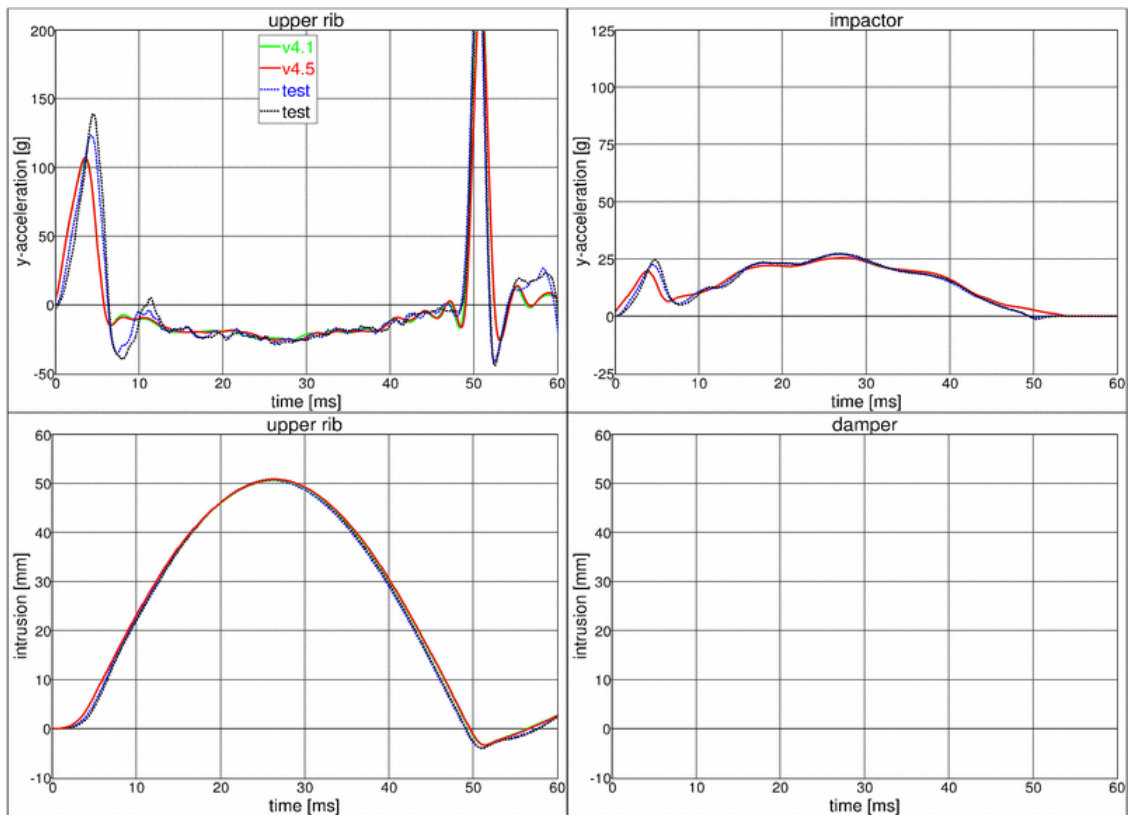

9.2.7 Test setup 2

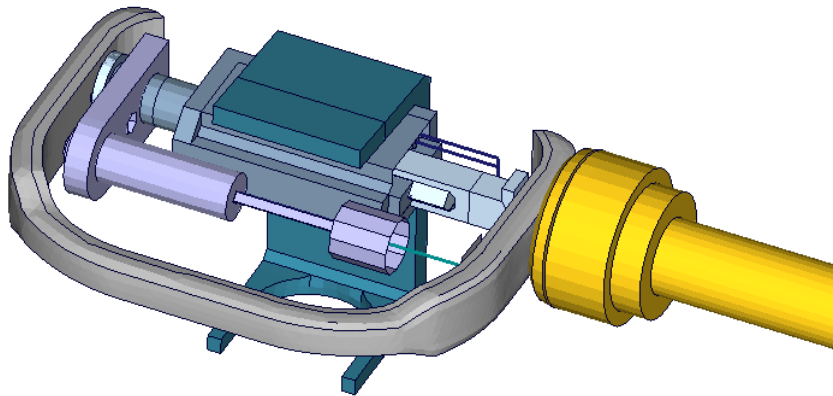
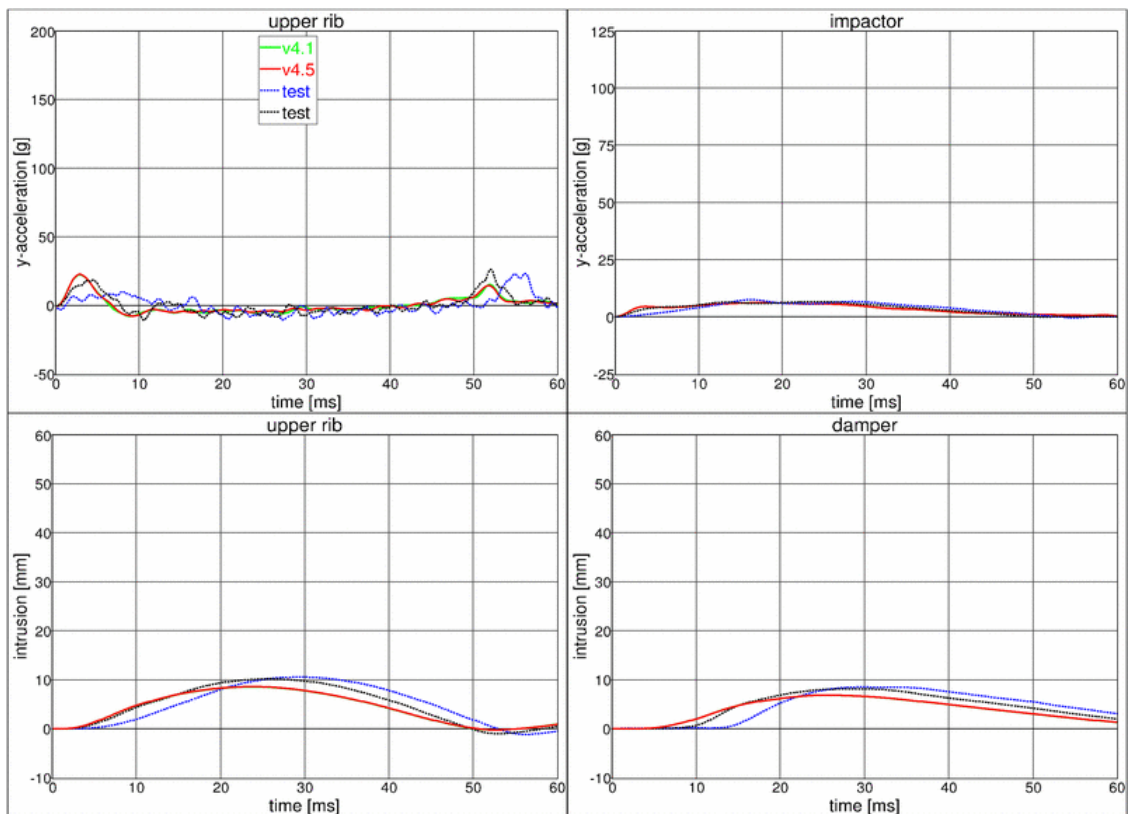

Figure 33: ES-2 rib module test setup 2

- Pendulum impacting the assembly at the rib guidance
- 5 impact velocities
- Damper assembly is included

9.2.8 Test setup 2: velocity 1 low mass



9.2.9 Test setup 2: velocity 1 high mass

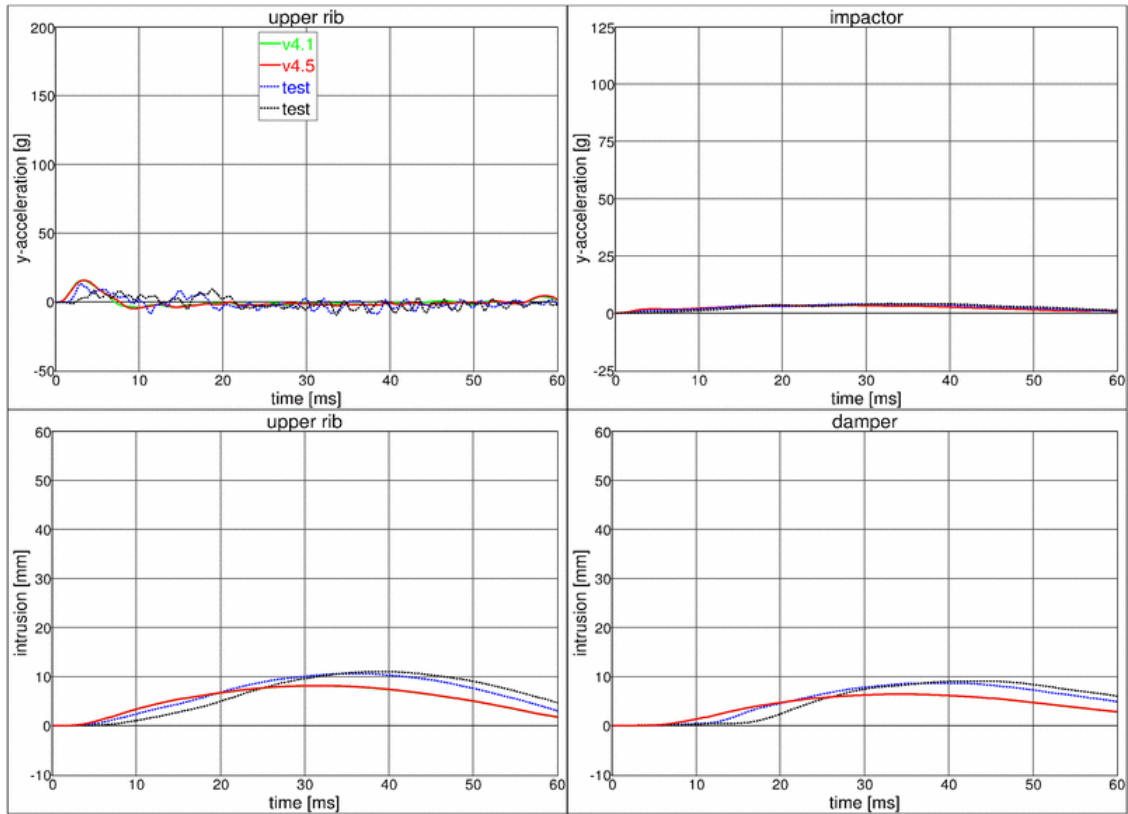

9.2.10 Test setup 2: velocity 2 low mass

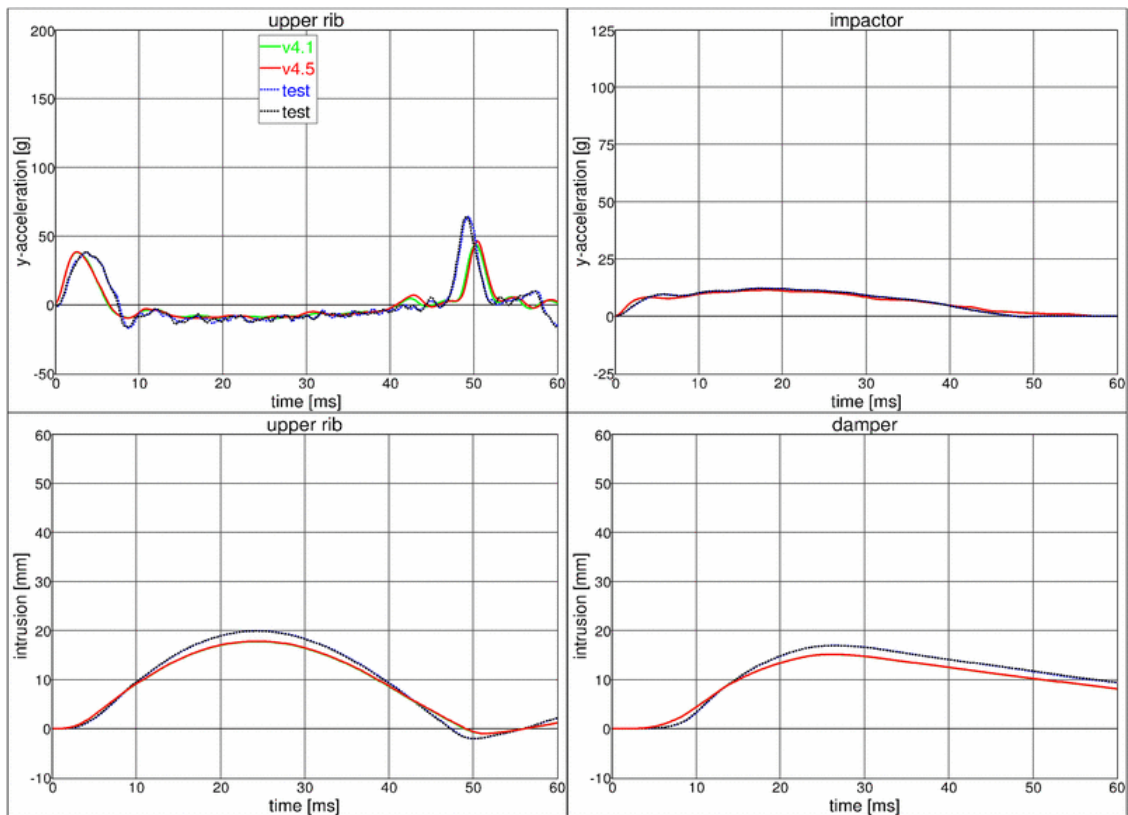

9.2.11 Test setup 2: velocity 2 high mass

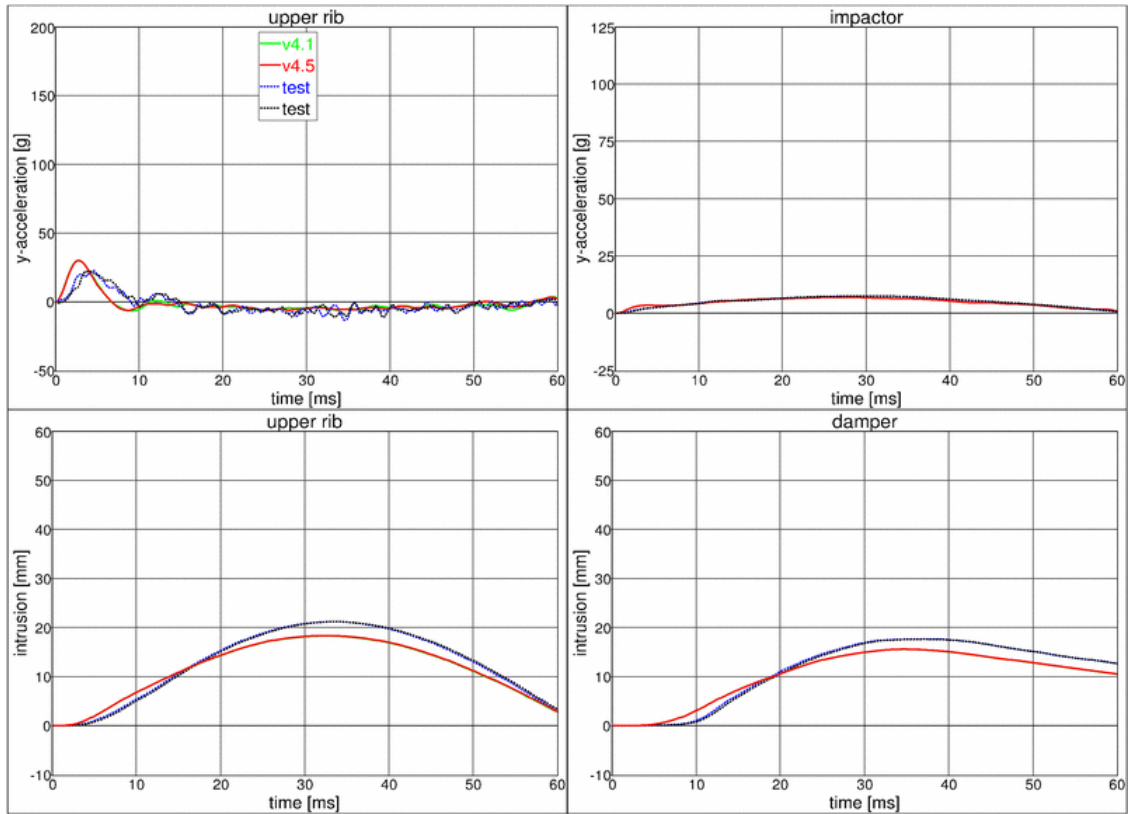

9.2.12 Test setup 2: velocity 3 low mass

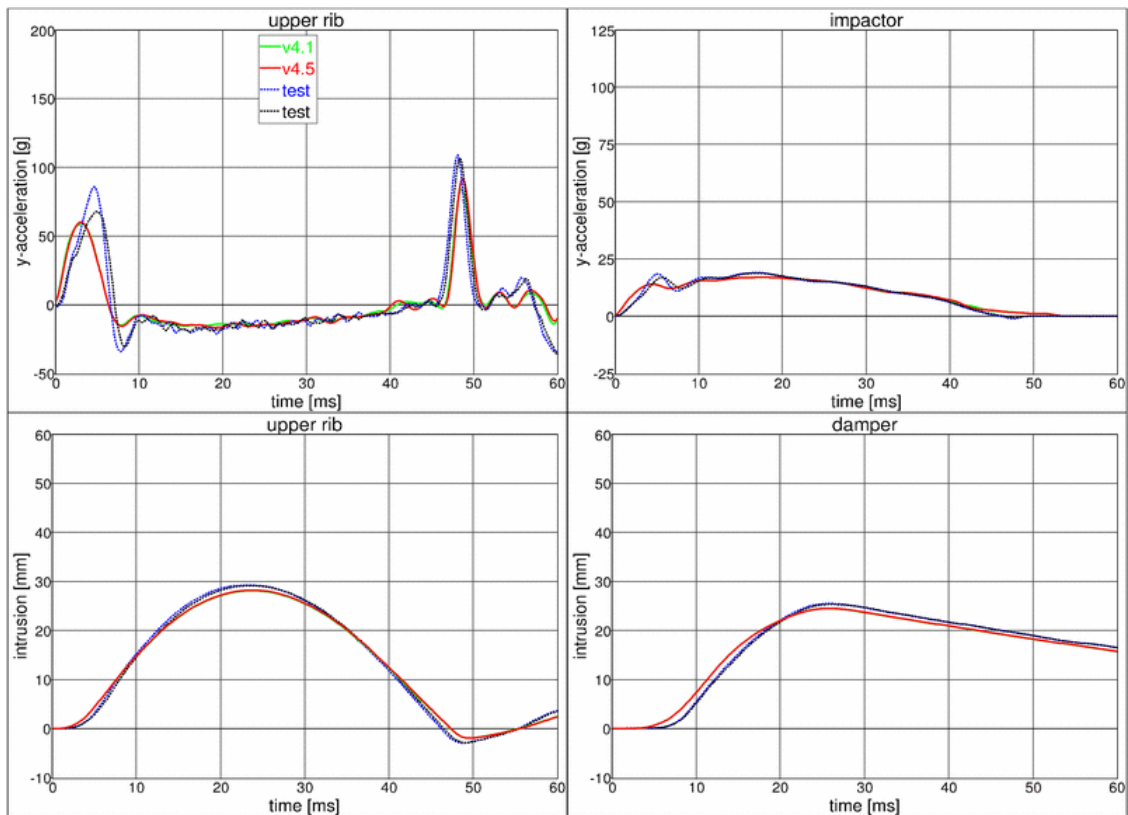

9.2.13 Test setup 2: velocity 3 high mass

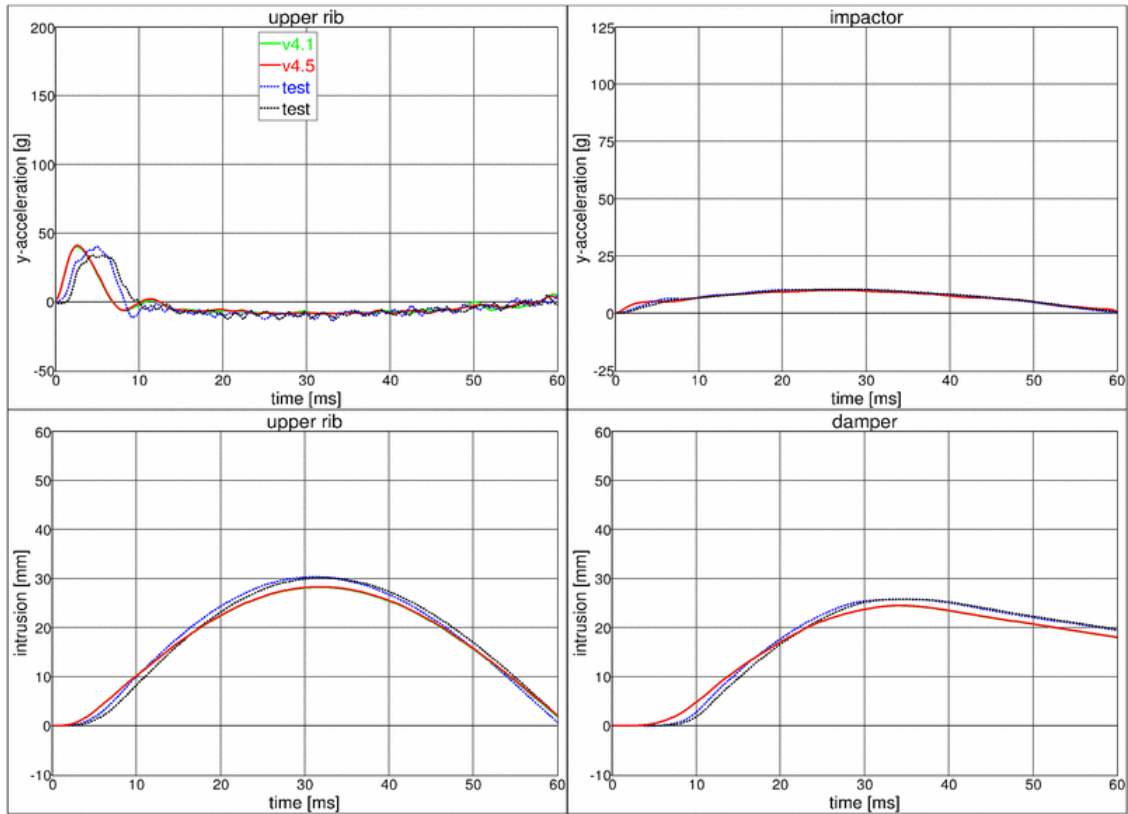

9.2.14 Test setup 2: velocity 4 low mass

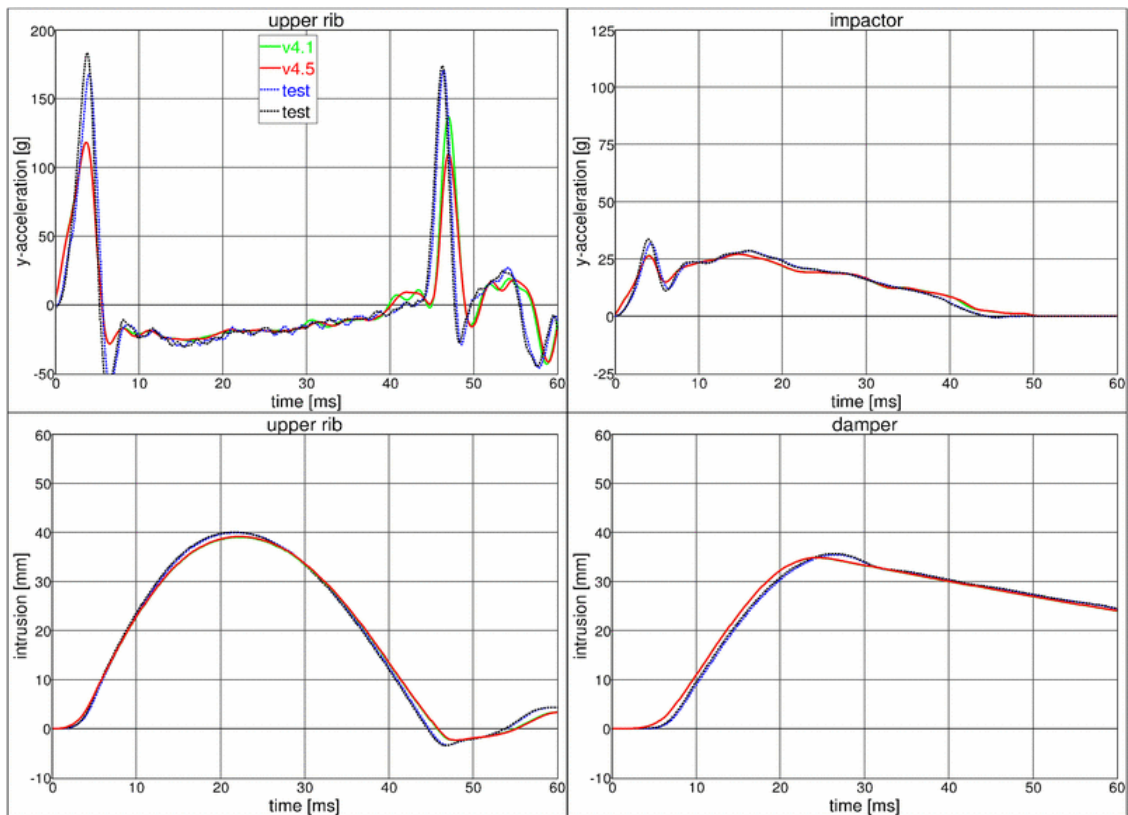

9.2.15 Test setup 2: velocity 4 high mass

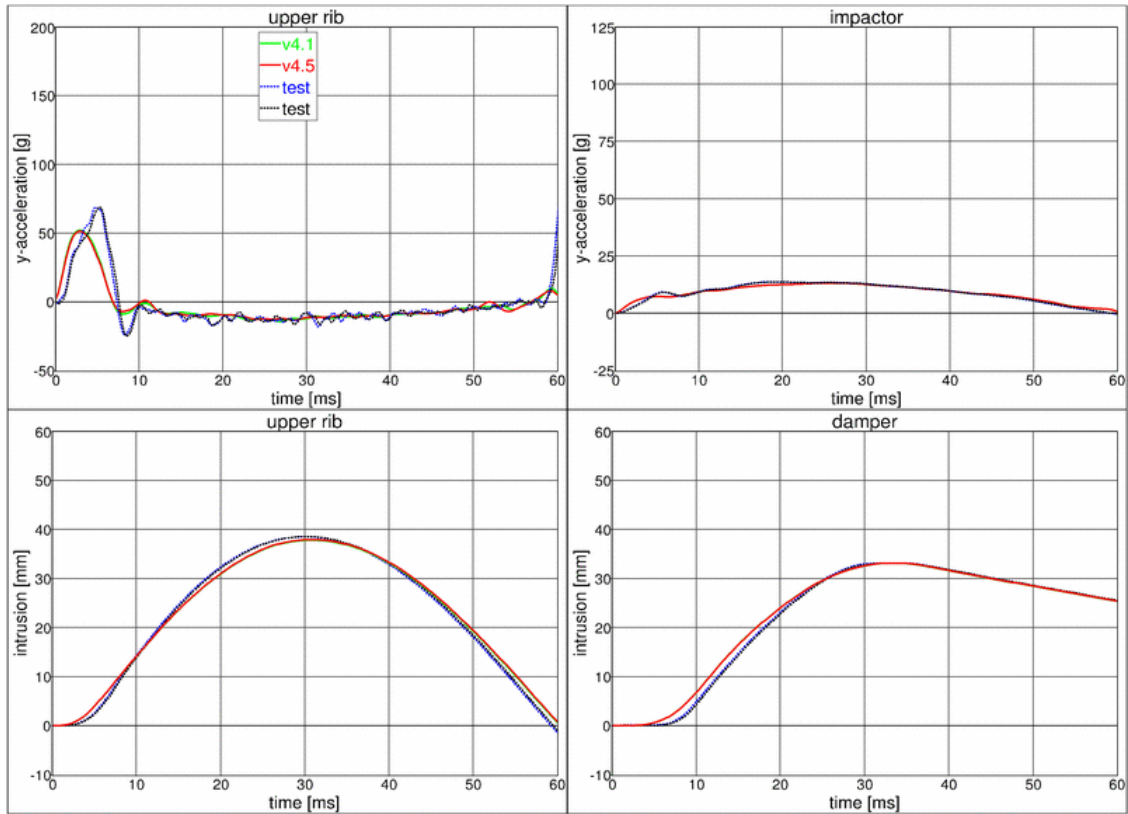

9.2.16 Test setup 2: velocity 5 low mass

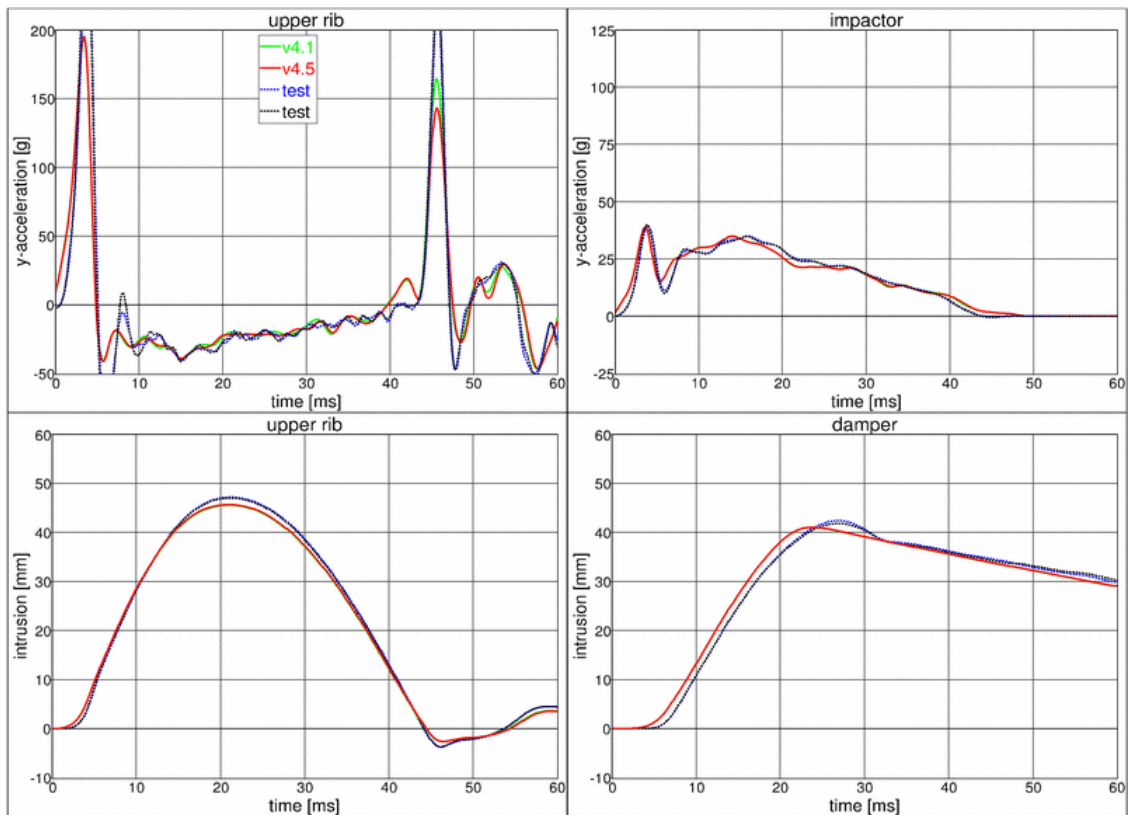

9.2.17 Test setup 2: velocity 5 high mass**9.2.18 Test setup 3**

Figure 34: ES-2 rib module test setup 3

- Pendulum impacting the assembly at the damper connection
- 5 impact velocities
- Damper assembly is included

9.2.19 Test setup 3: velocity 1

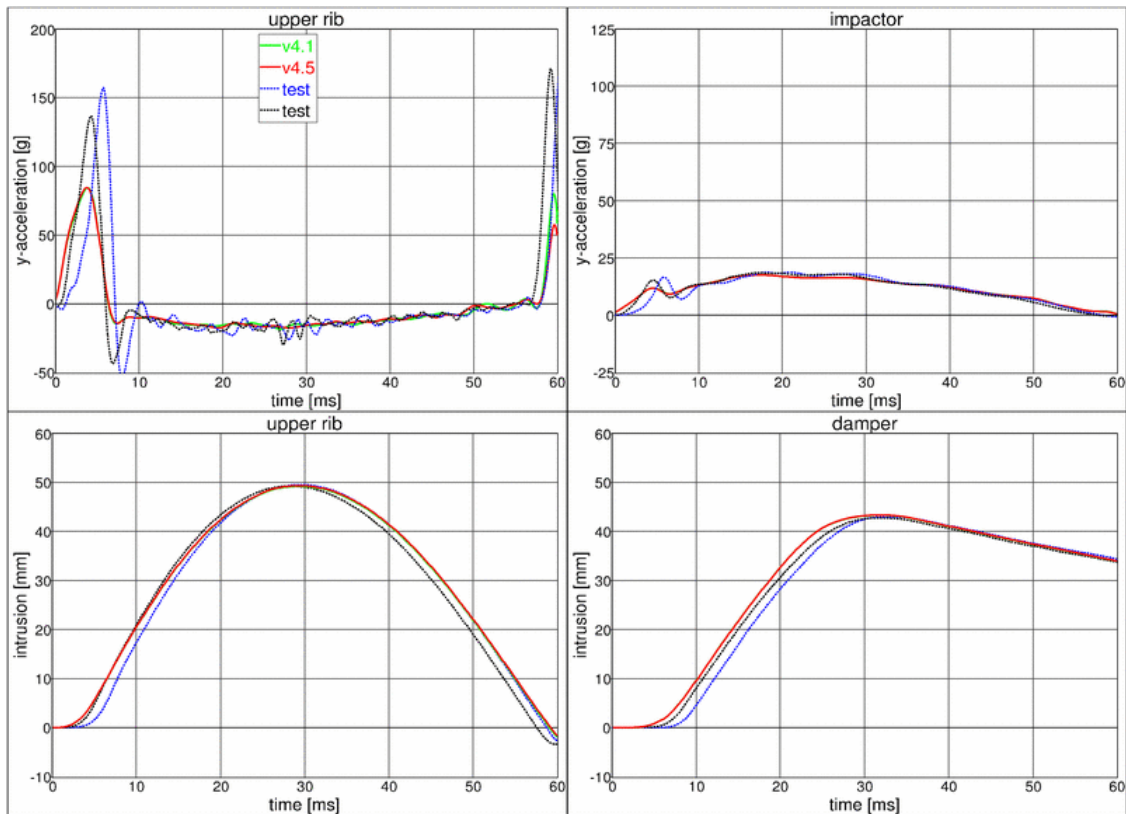
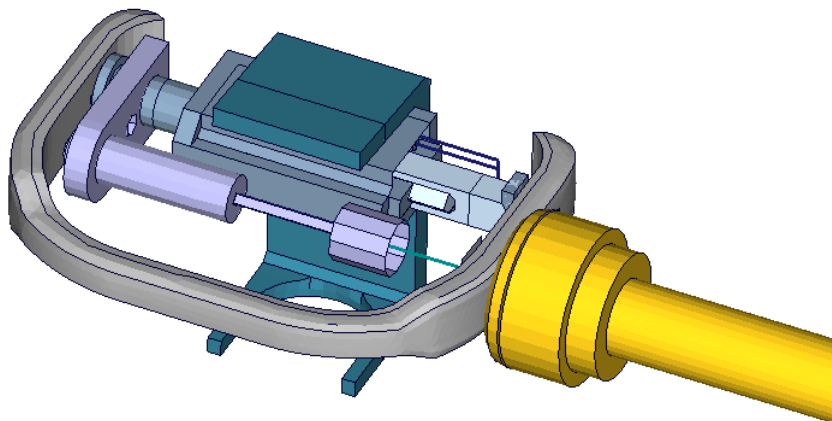
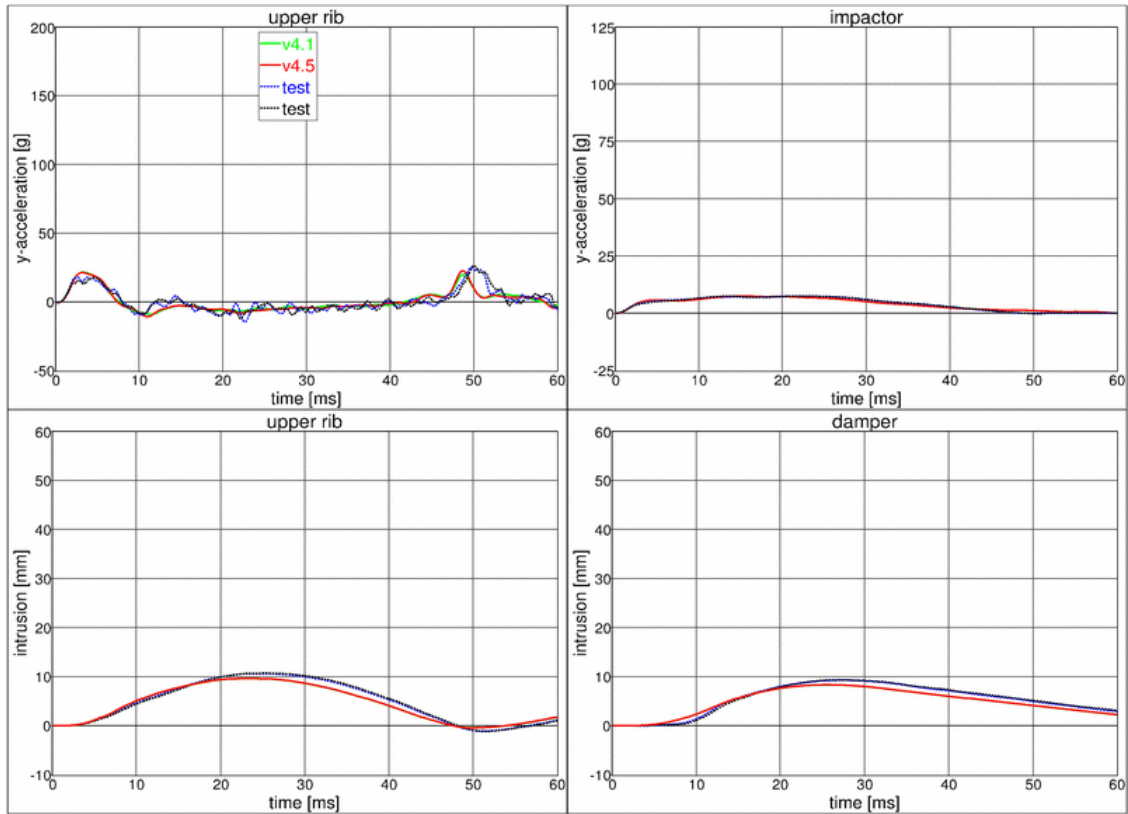

9.2.20 Test setup 3: velocity 2

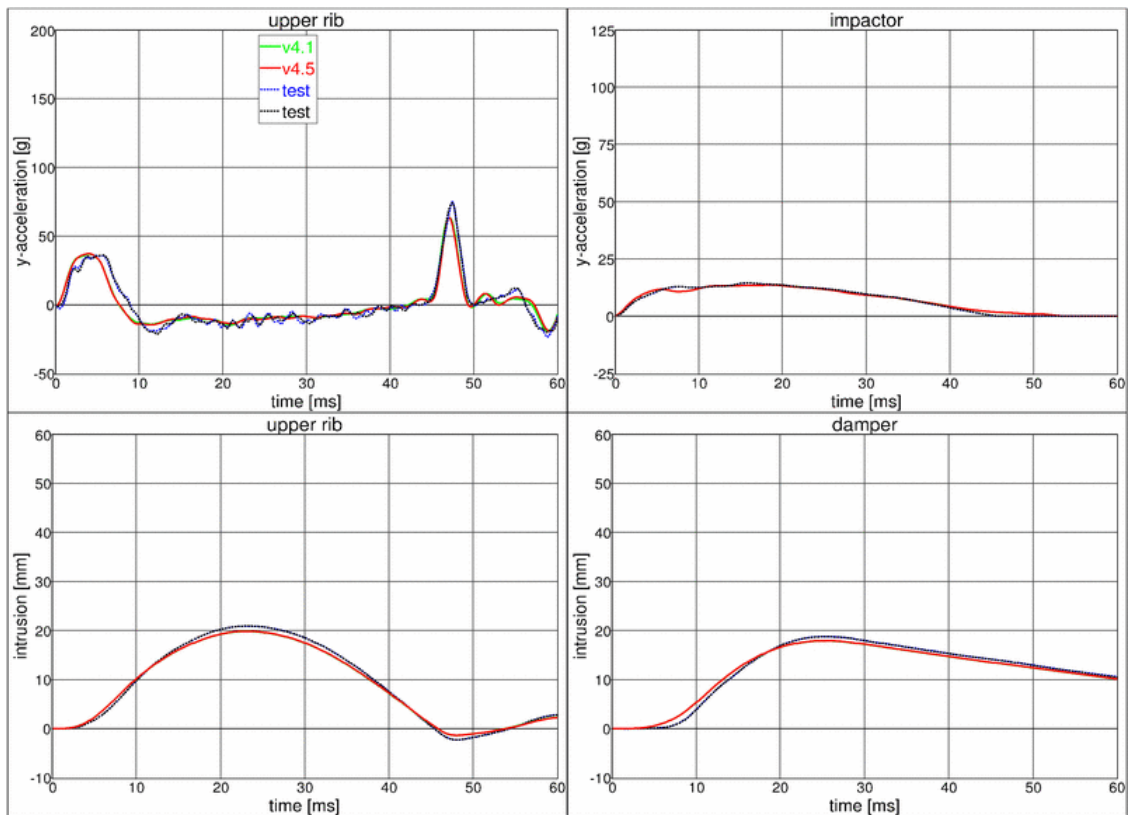

9.2.21 Test setup 3: velocity 3

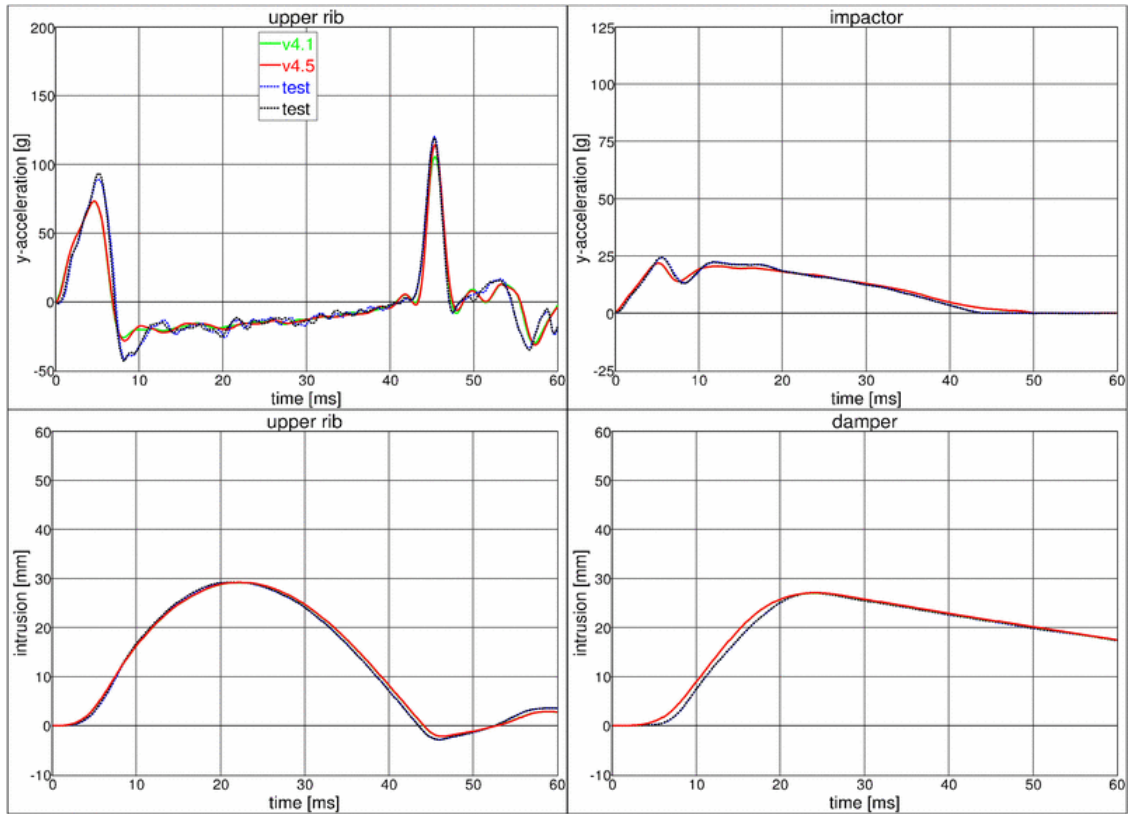

9.2.22 Test setup 3: velocity 4

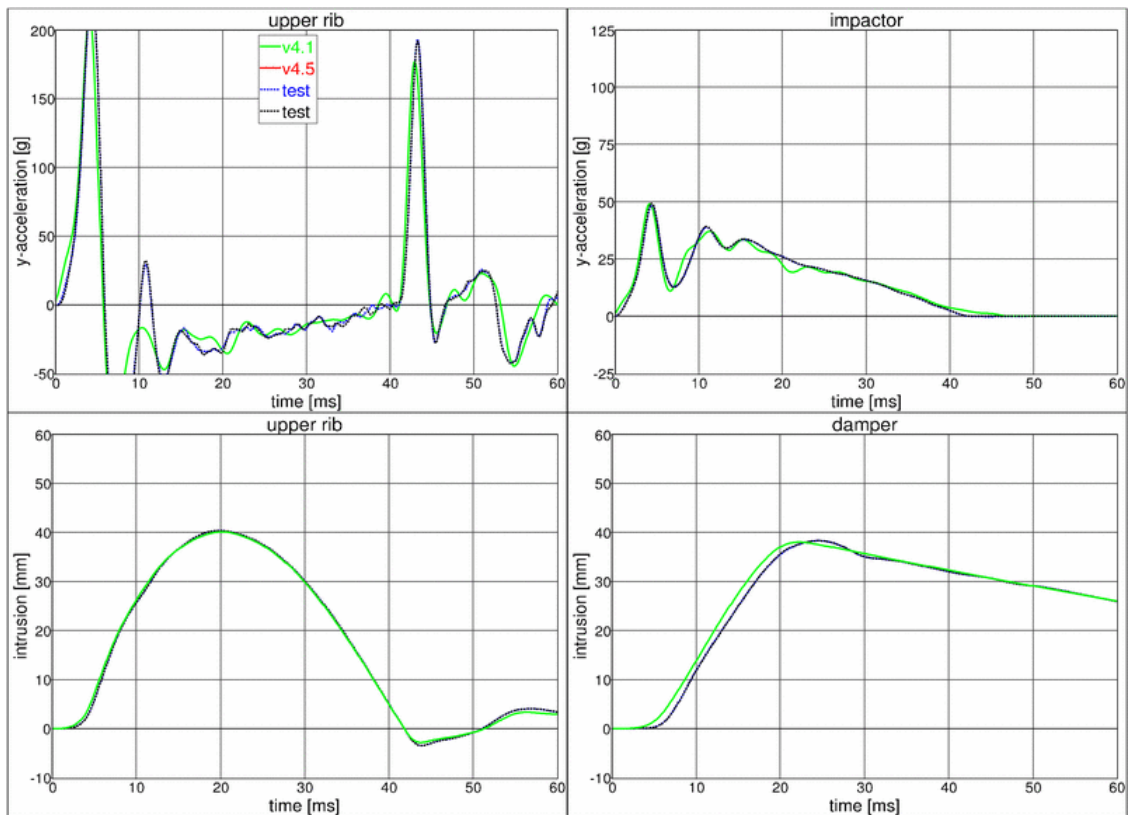

9.2.23 Test setup 3: velocity 5

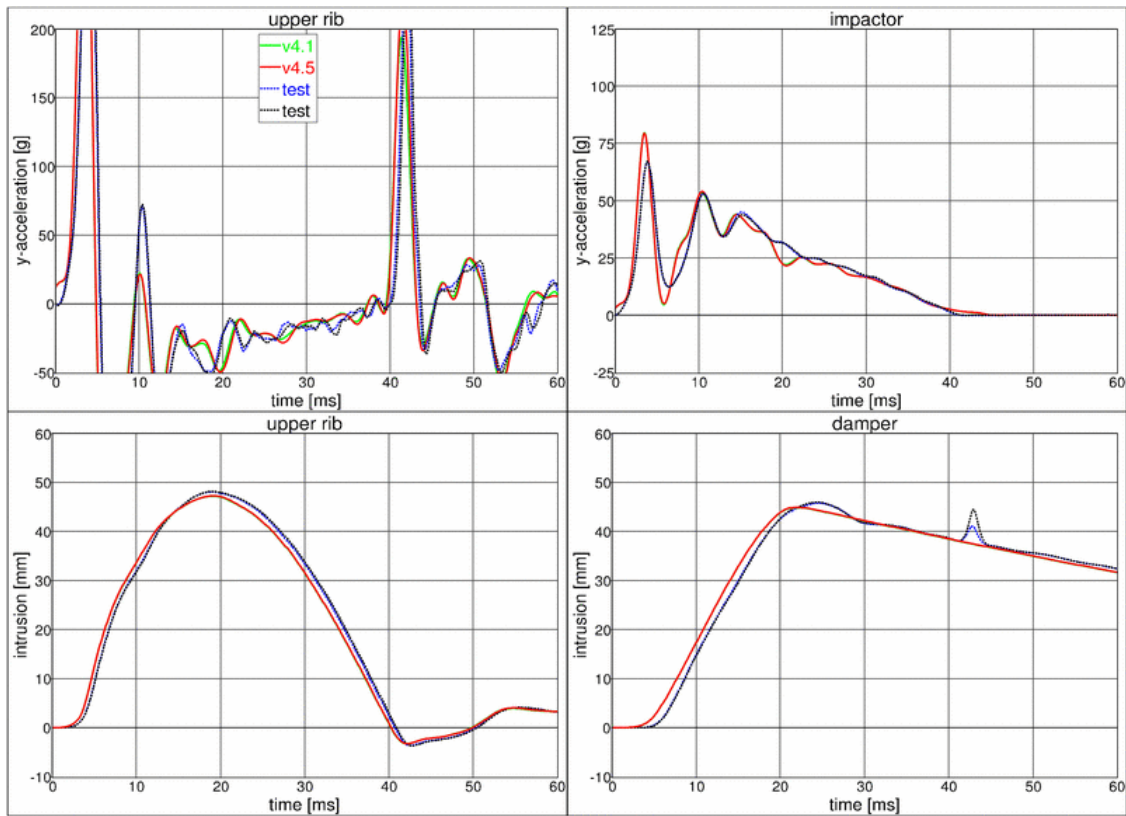

9.2.24 Test setup 4

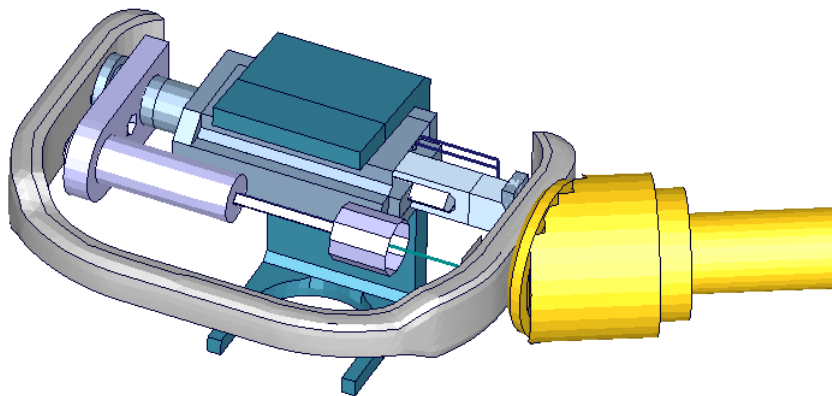
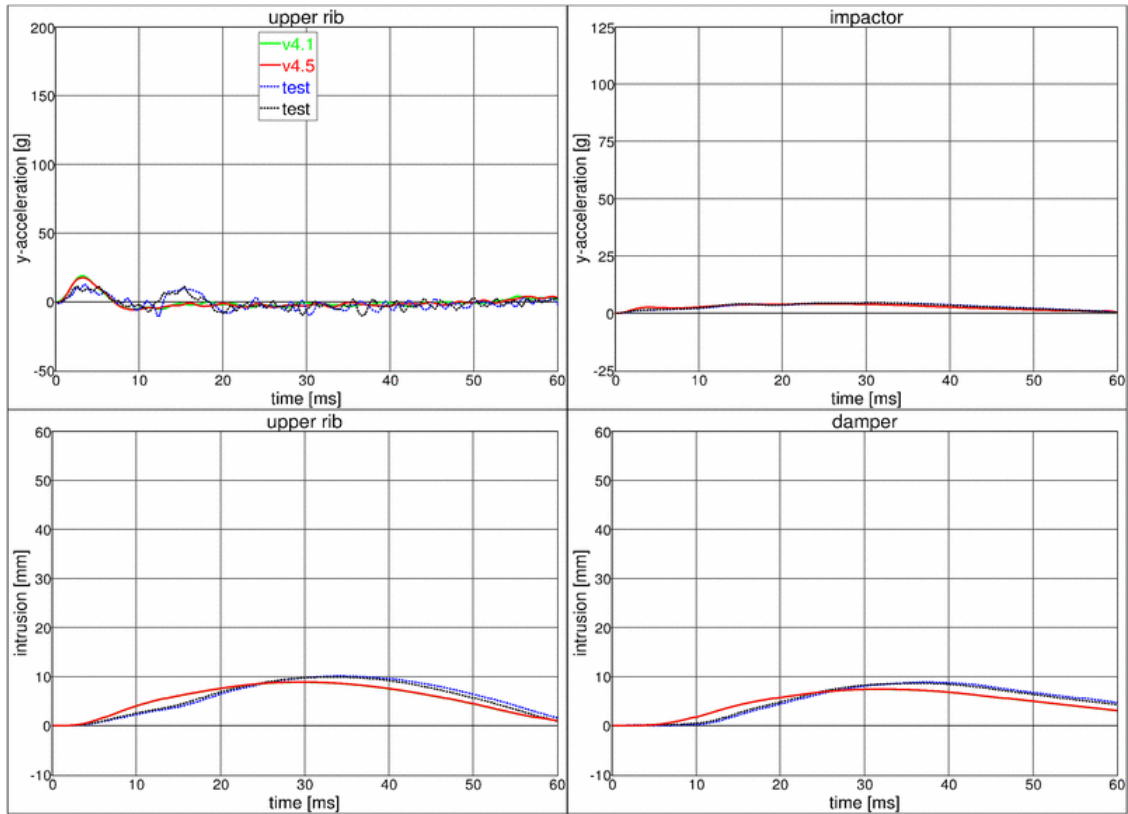

Figure 35: ES-2 rib module test setup 4

- Pendulum impacting the assembly at between damper and guidance
- 5 impact velocities
- Damper assembly is included
- The impact direction is oblique

9.2.25 Test setup 4: velocity 1



9.2.26 Test setup 4: velocity 2

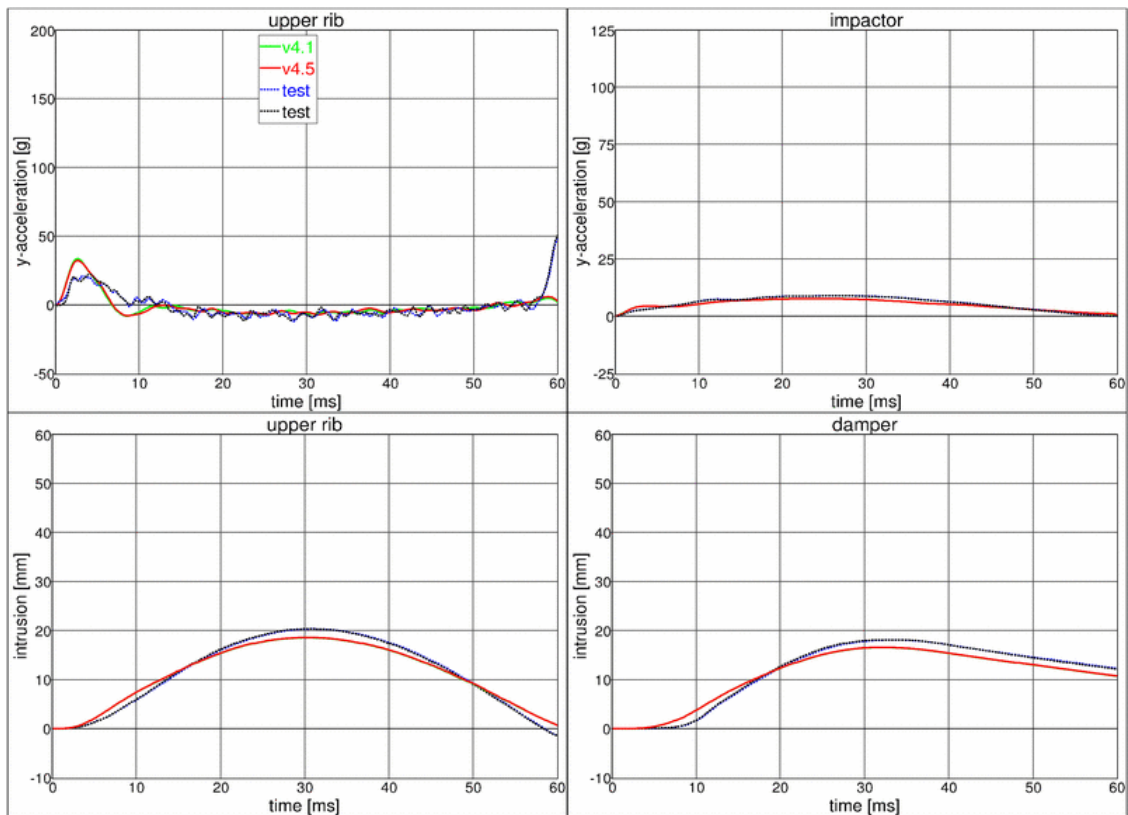

9.2.27 Test setup 4: velocity 3

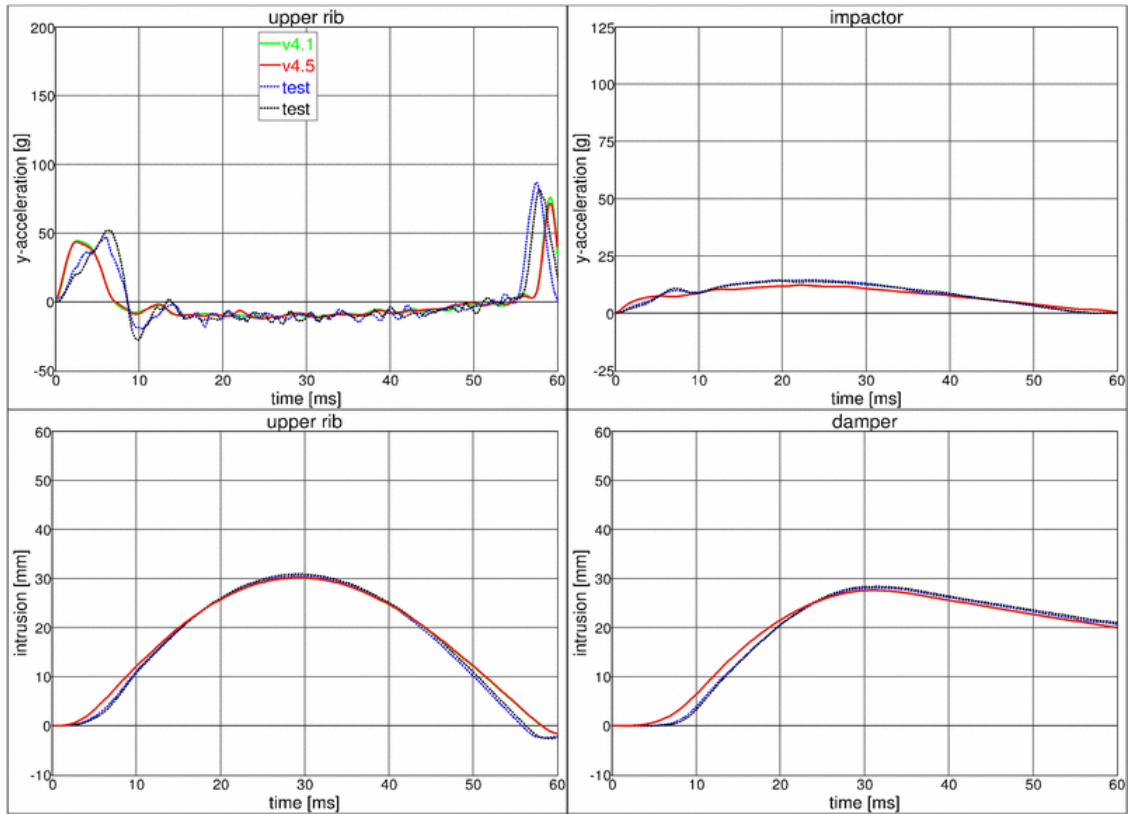

9.2.28 Test setup 4: velocity 4

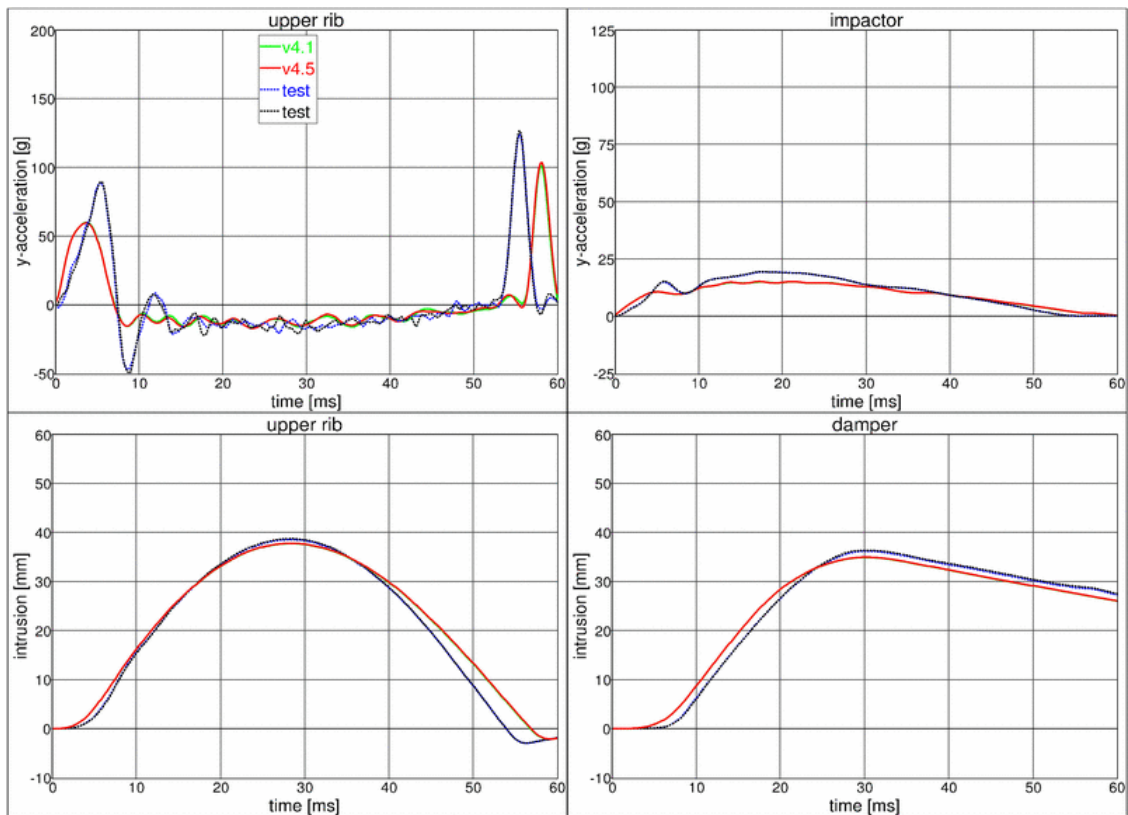

9.2.29 Test setup 4: velocity 5

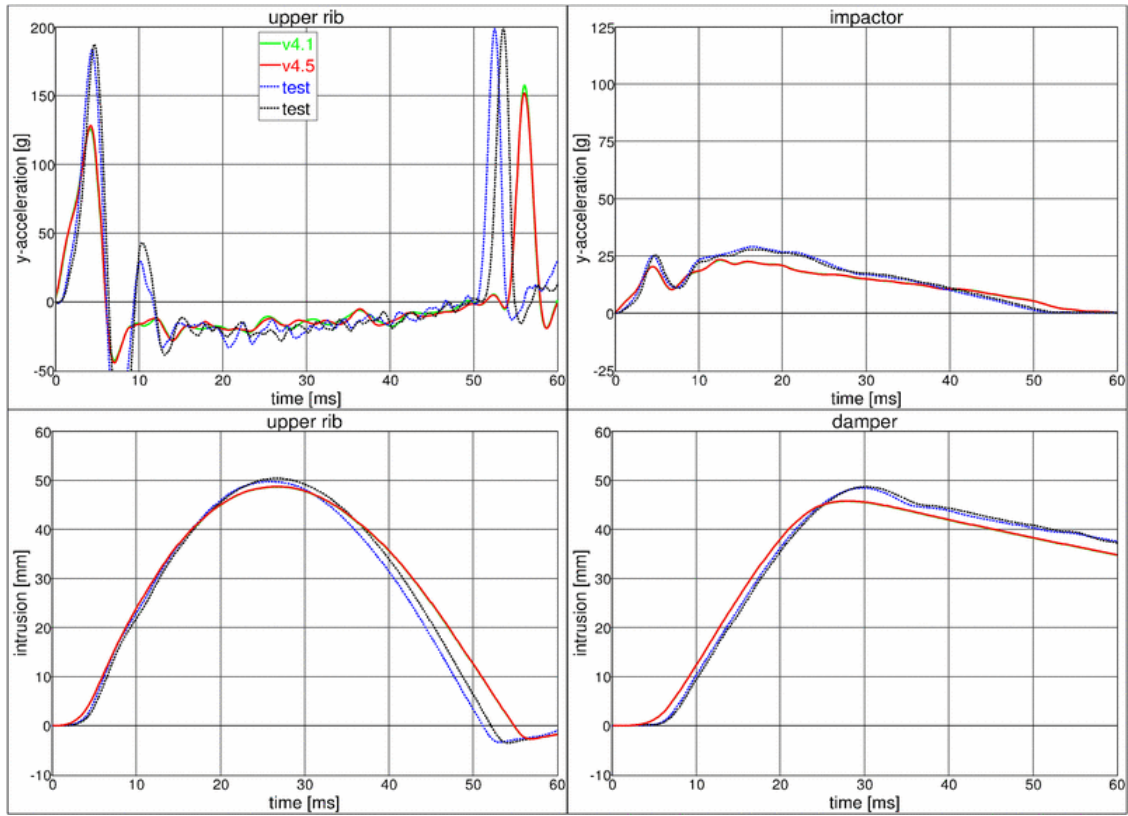

10. Performance

10.1 Configuration D1: Plane Barrier

Boundaries:

- Rigid barrier (Figure 36)
- Impact speed: Low velocity
- Arms in 40 degree position
- Orthogonal impact

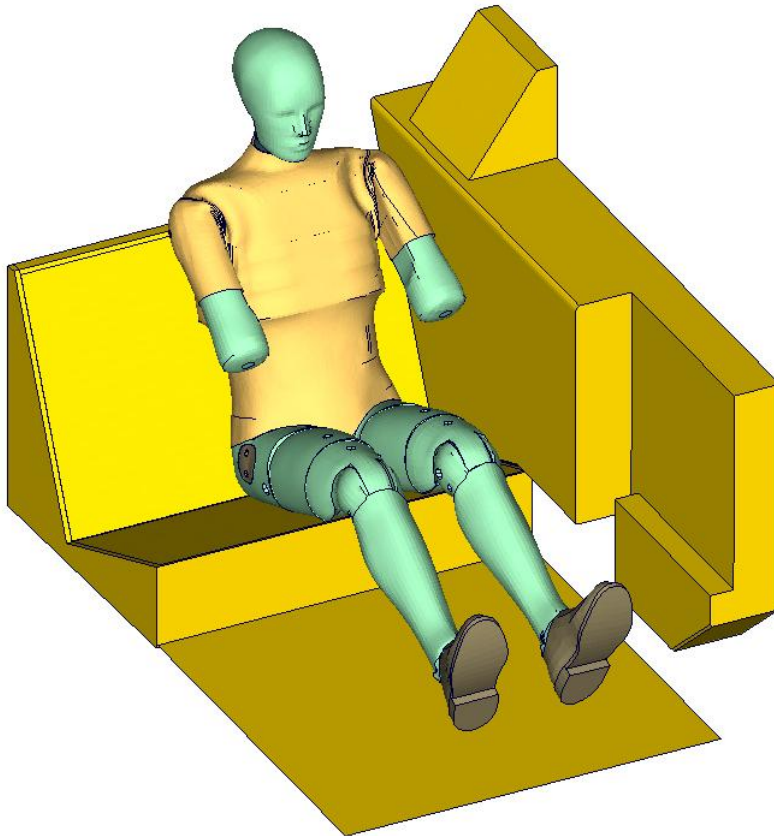
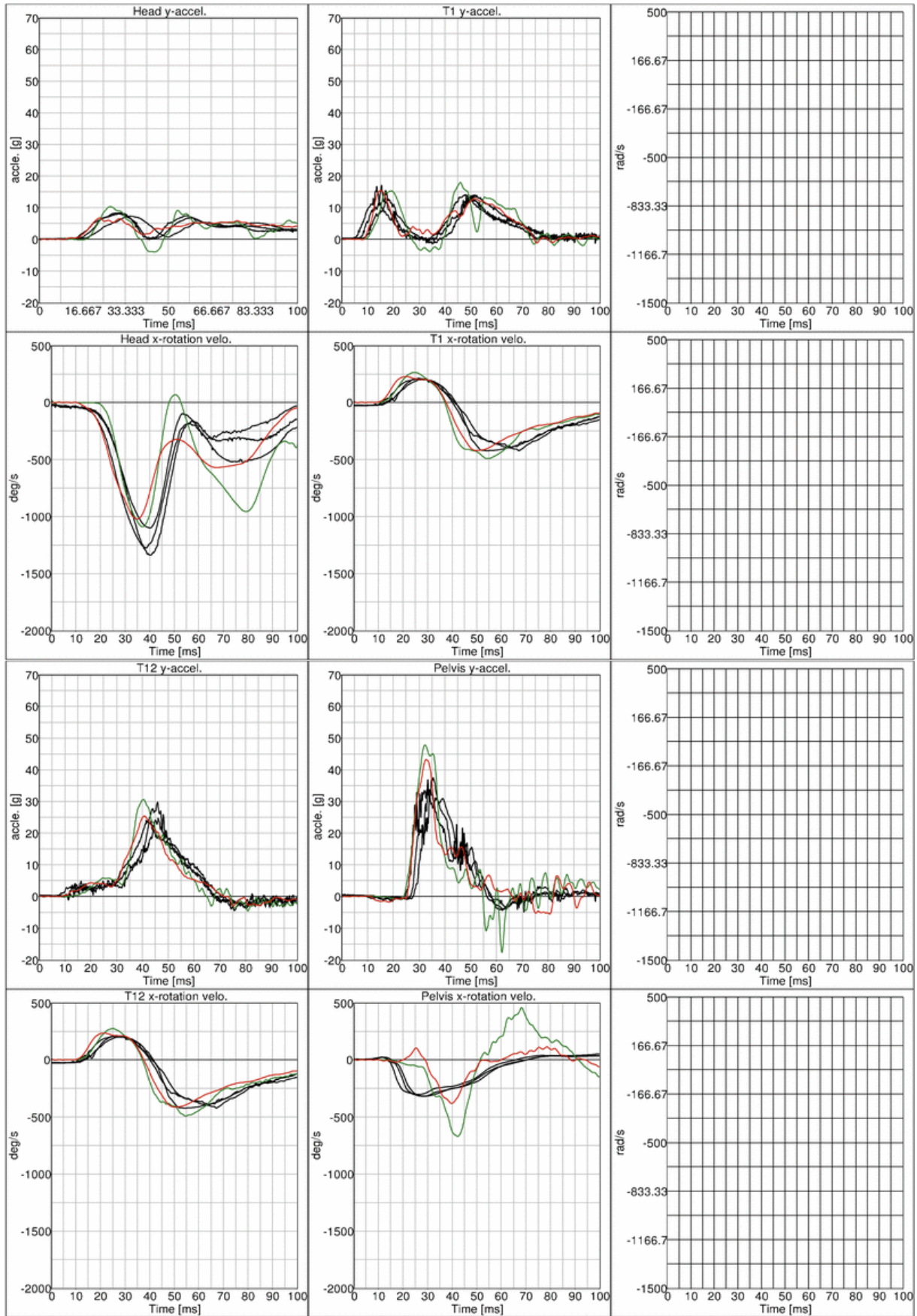
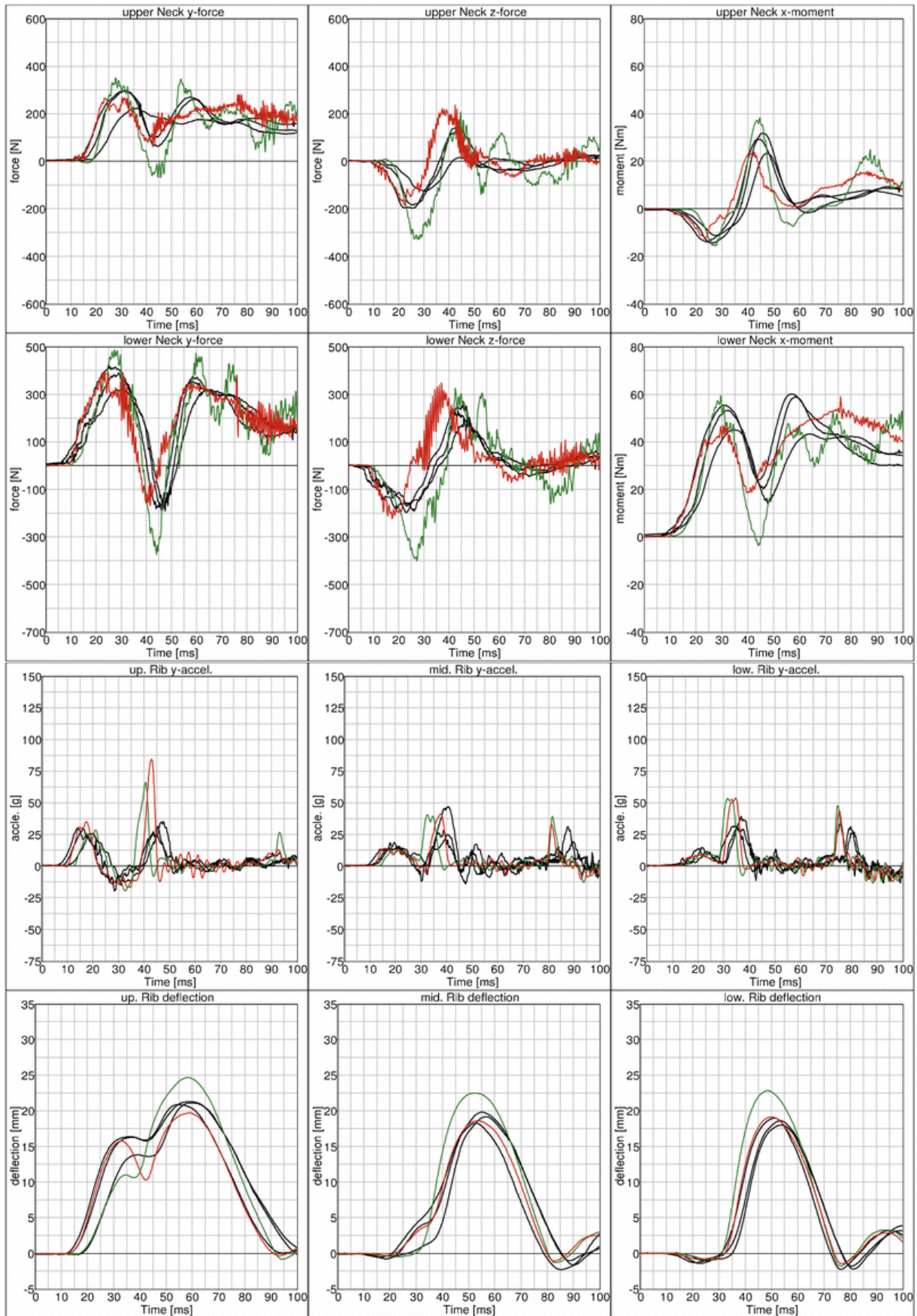
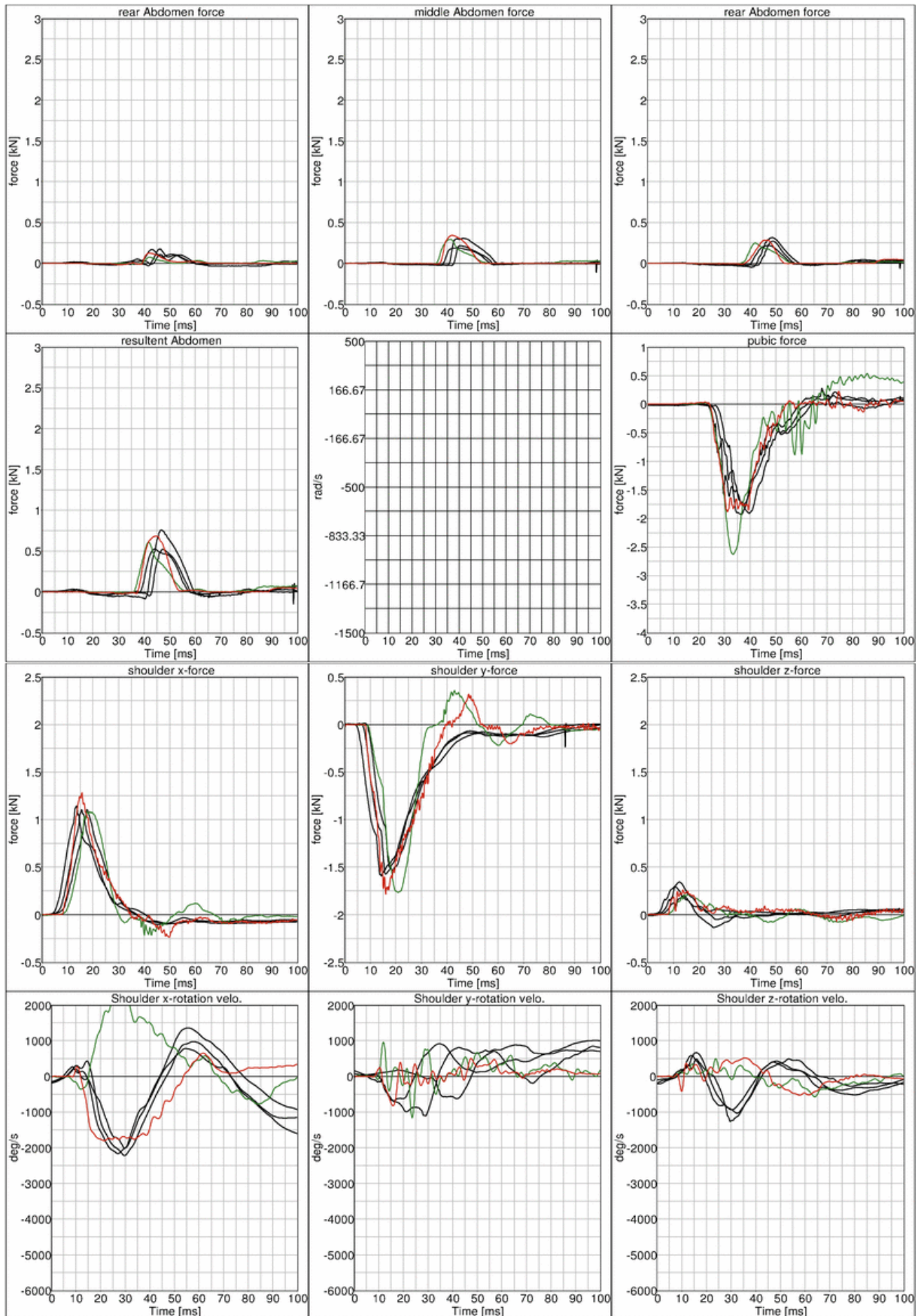

Figure 36: D1 plane barrier test setup

10.1.1 Results at low velocity impact







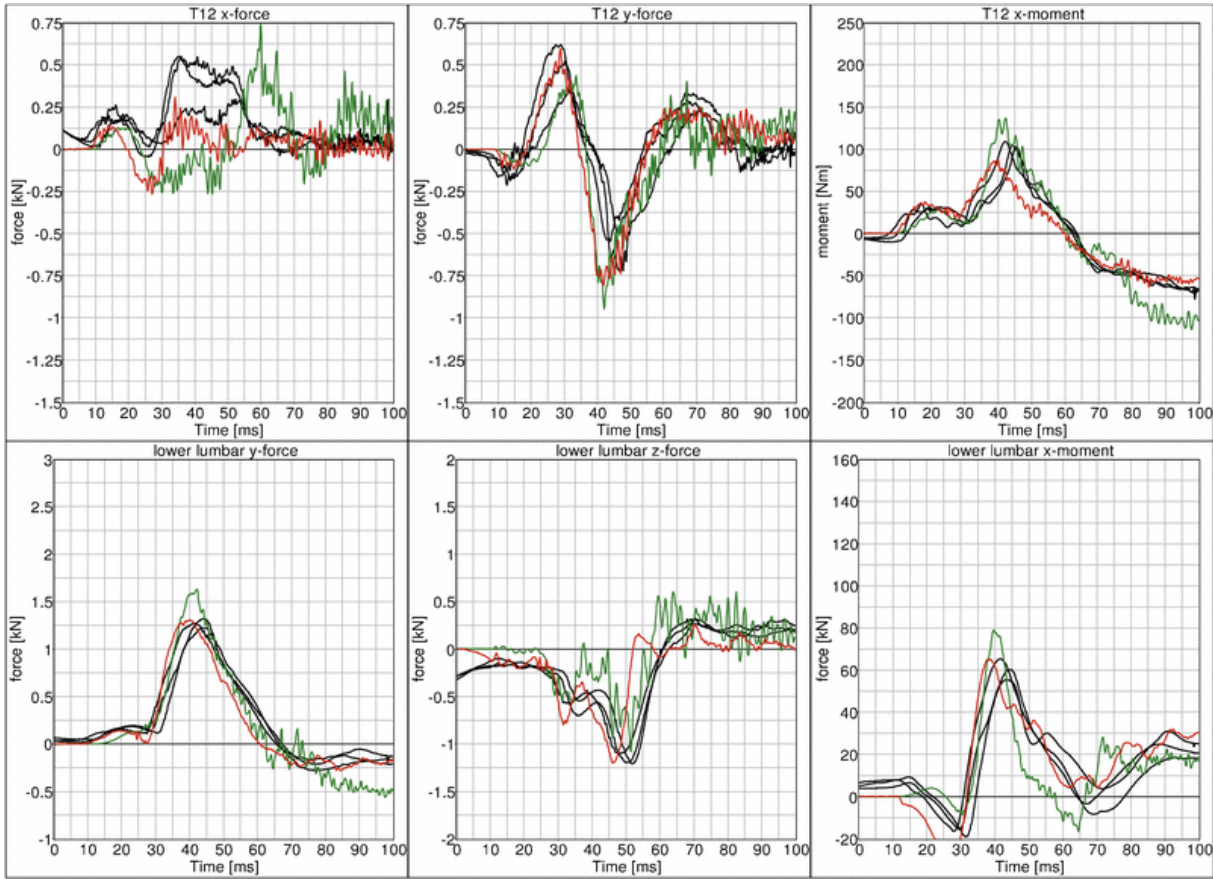

10.2 Configuration D3: Barrier with pelvis bumper

Boundaries:

- Rigid barrier (Figure 37)
- Impact speed: High velocity
- Arms in 40 degree position
- Pelvis pusher
- Oblique impact

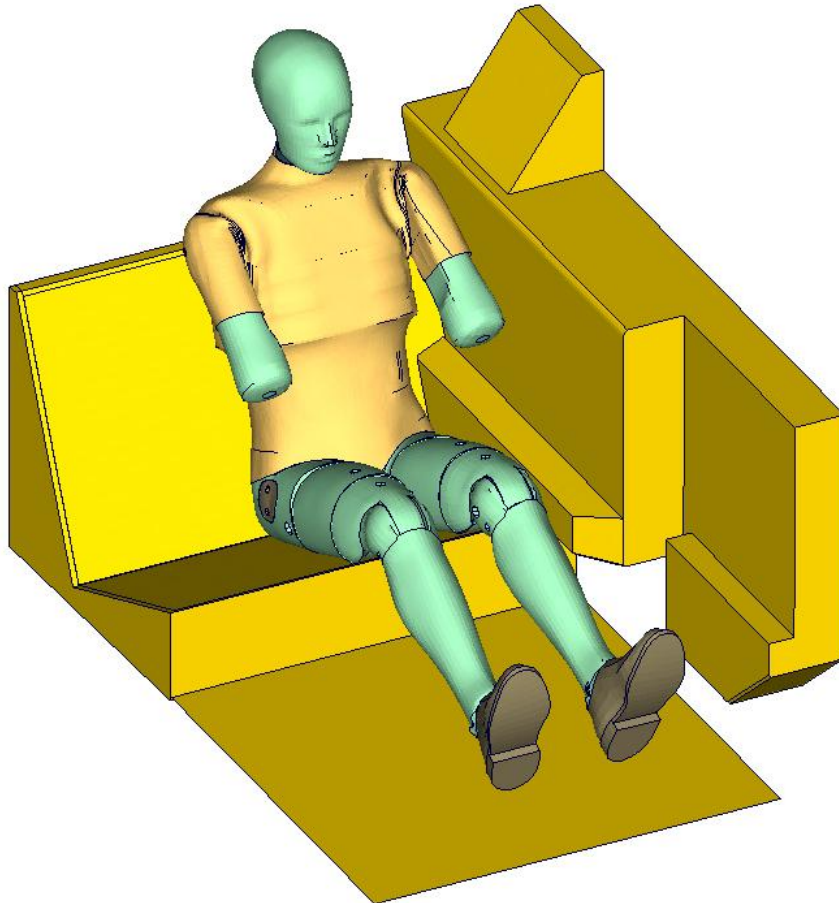
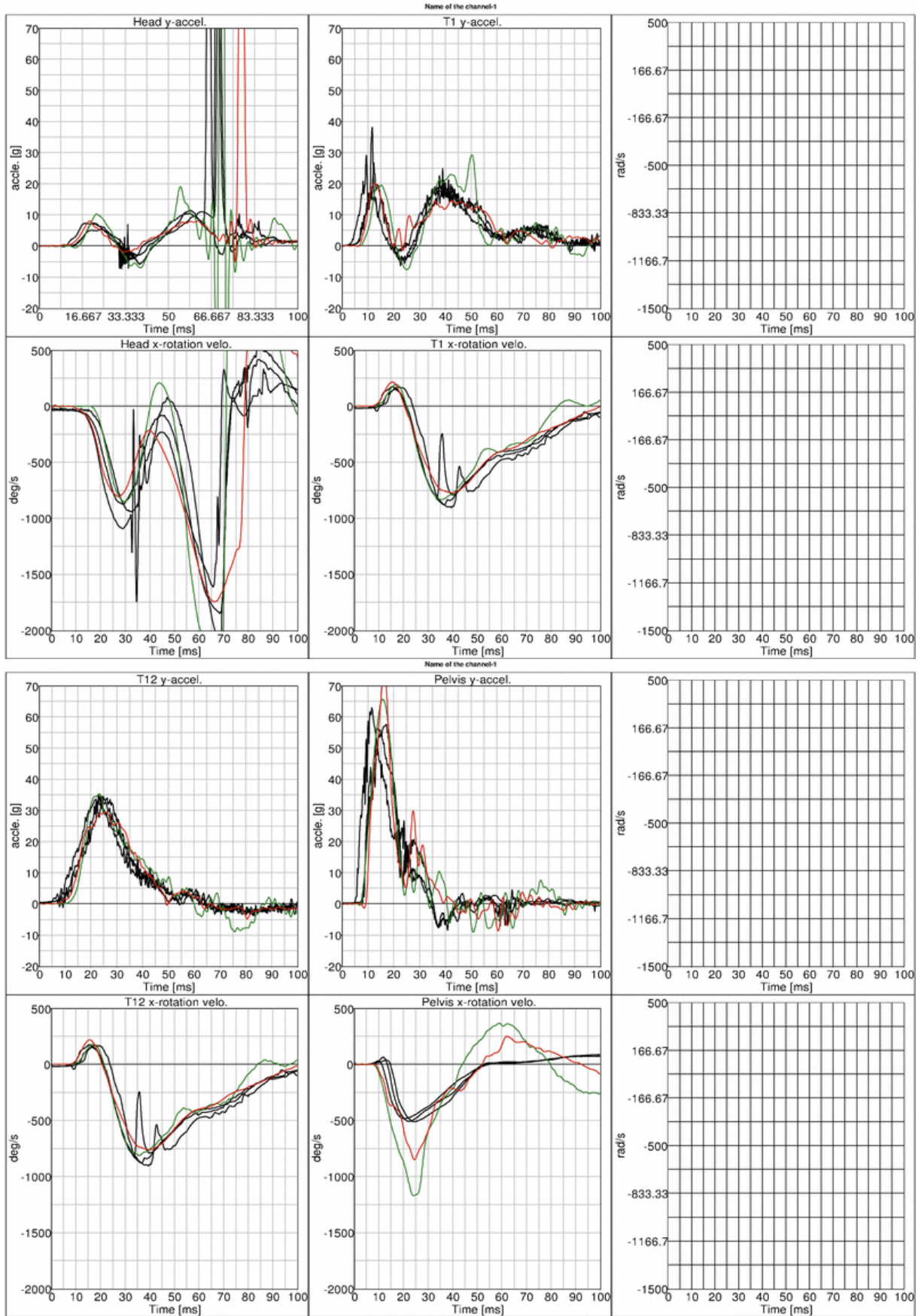
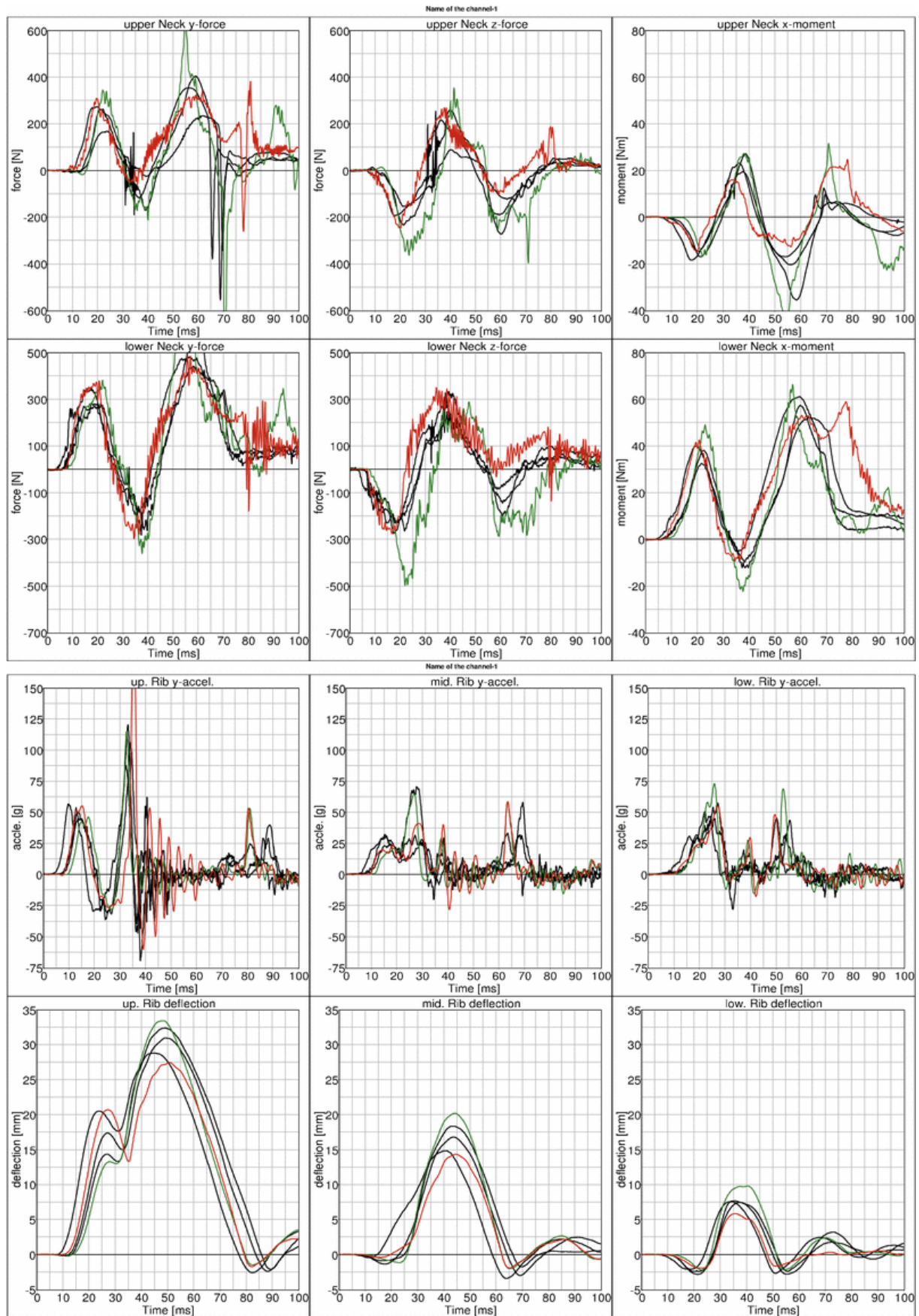

Figure 37: D3 barrier test setup

10.2.1 Results at high velocity impact



Performance



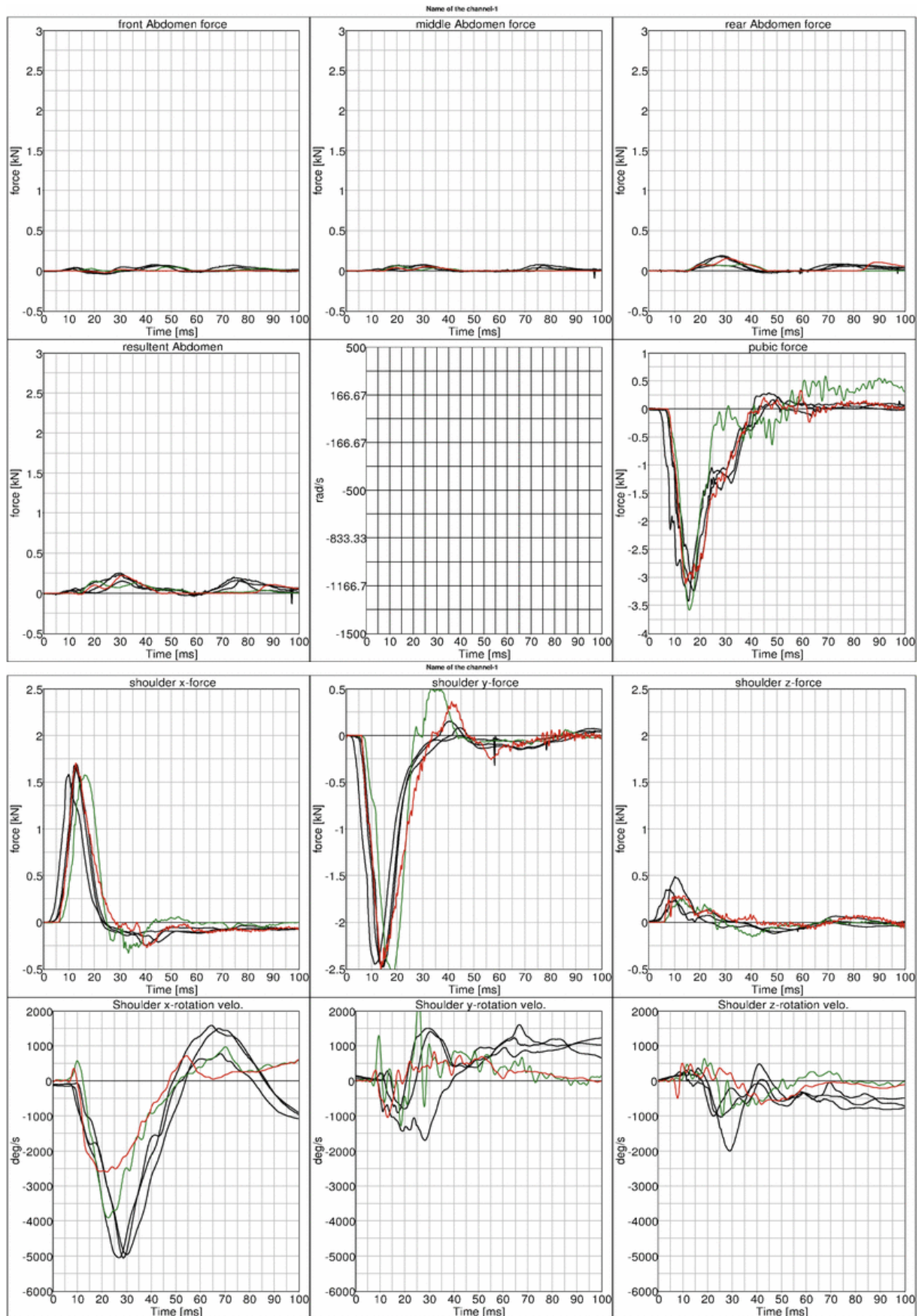

Performance

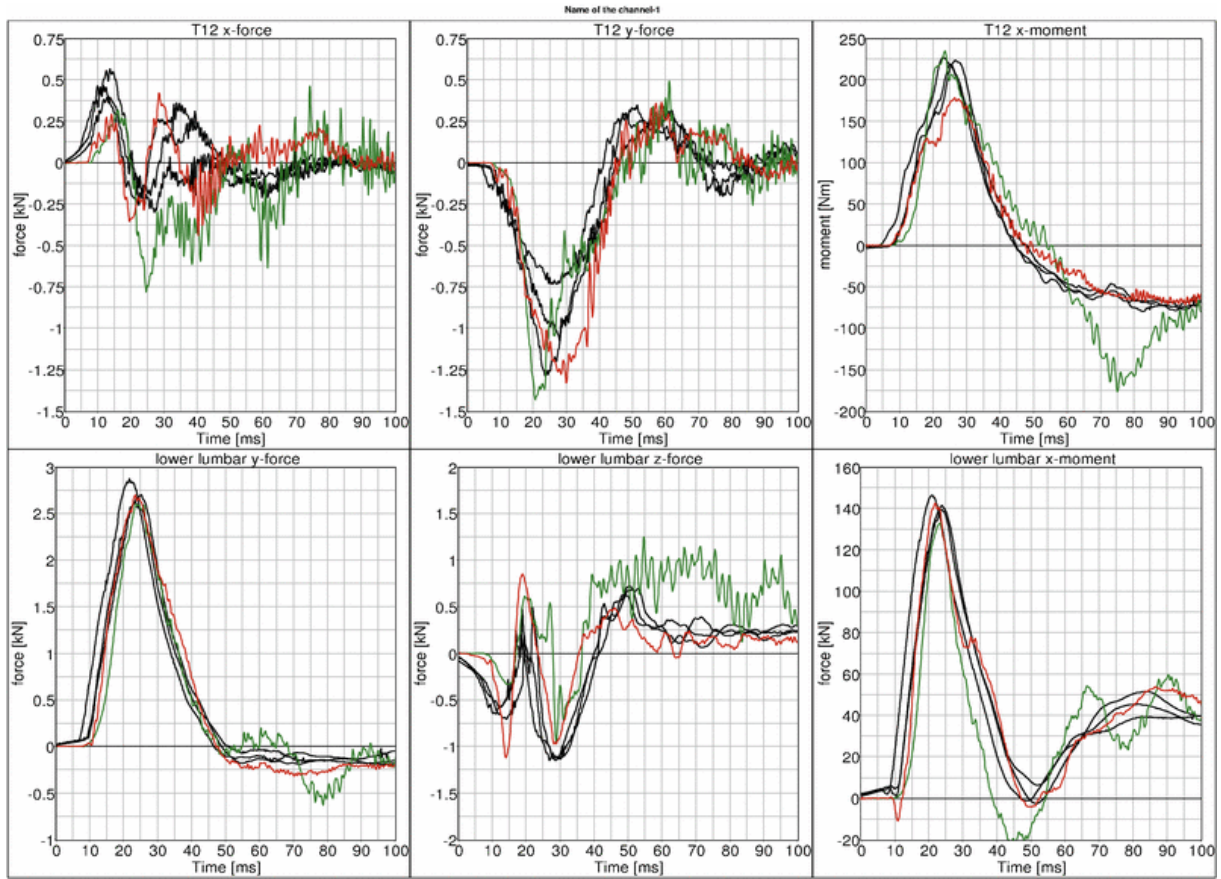

10.3 Configuration D4: Door barrier

Boundaries:

- Rigid barrier (Figure 38)
- Impact speed: High velocity
- Arms in 40 degree position
- Curb edge
- Orthogonal impact

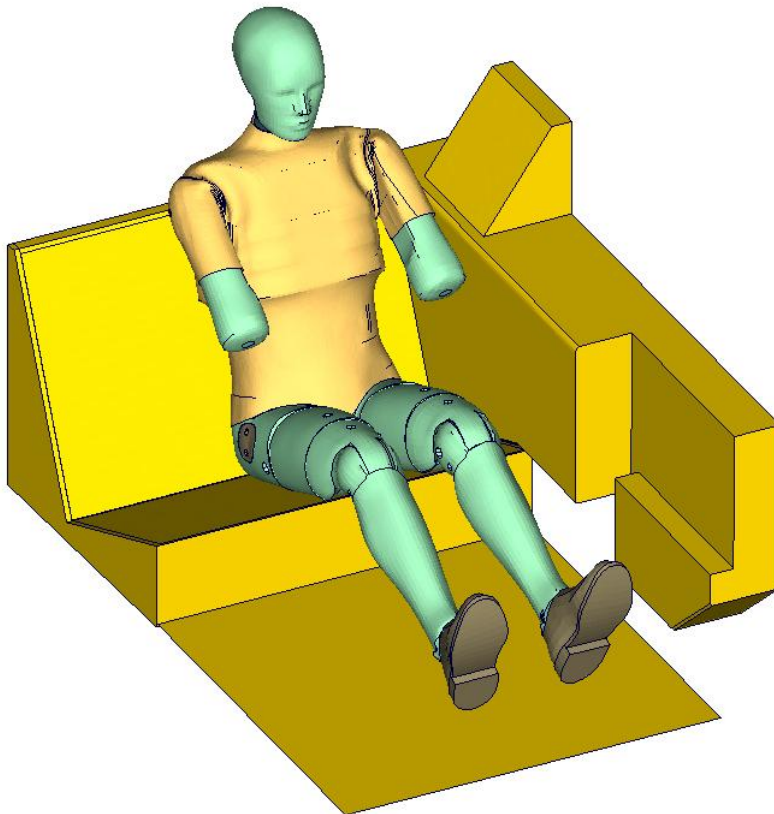
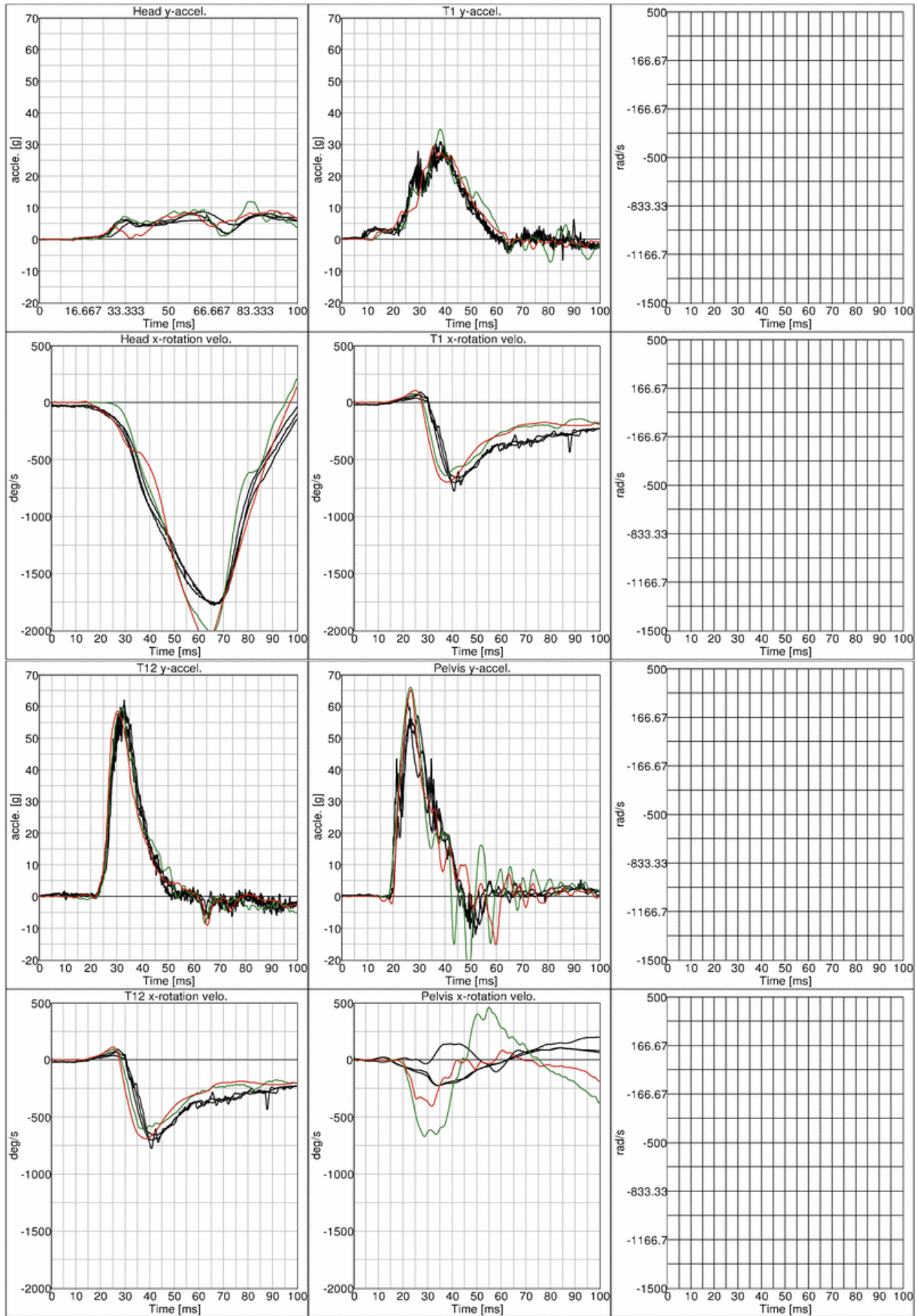
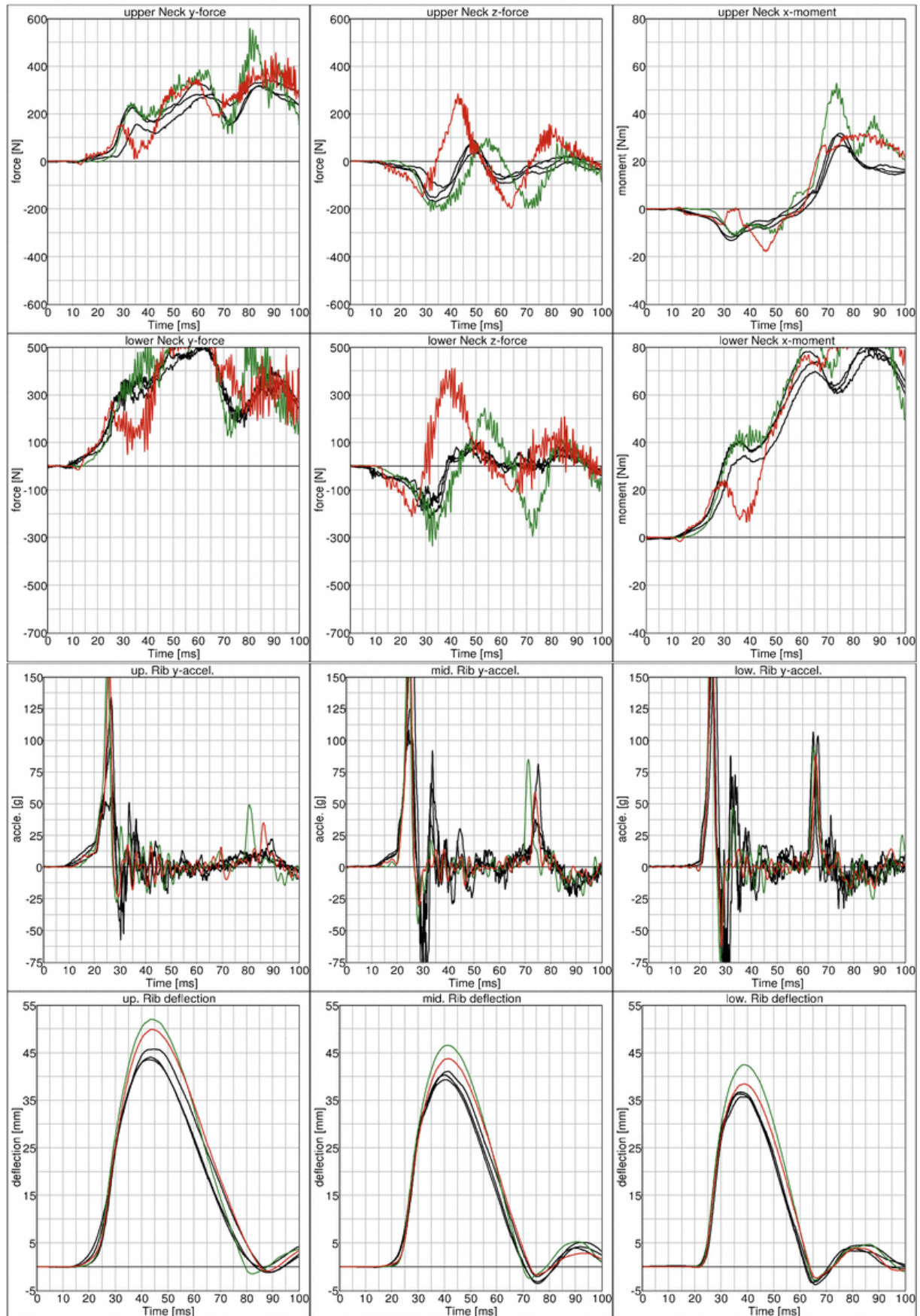
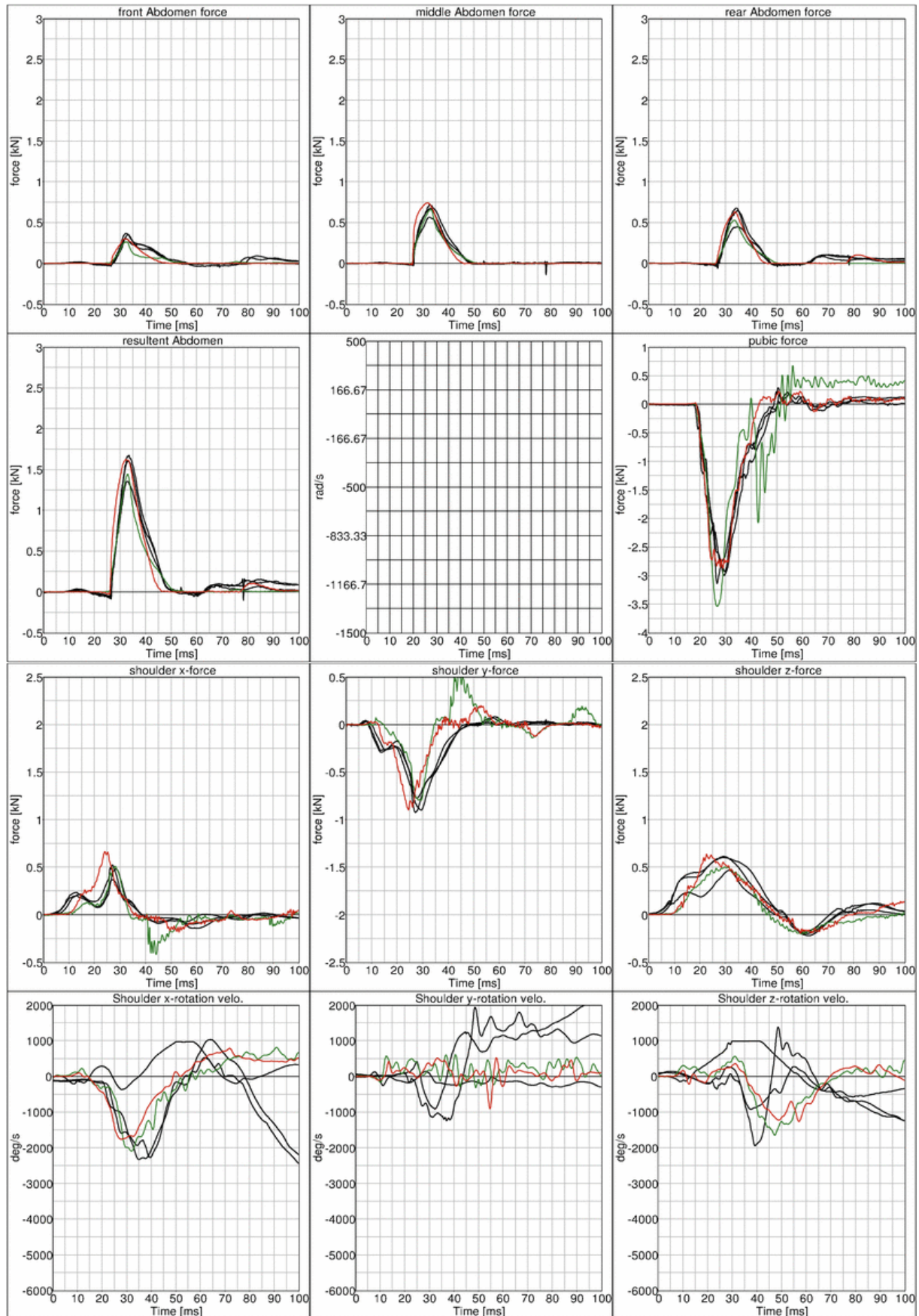

Figure 38: D4 door barrier test setup

10.3.1 Results at high velocity impact







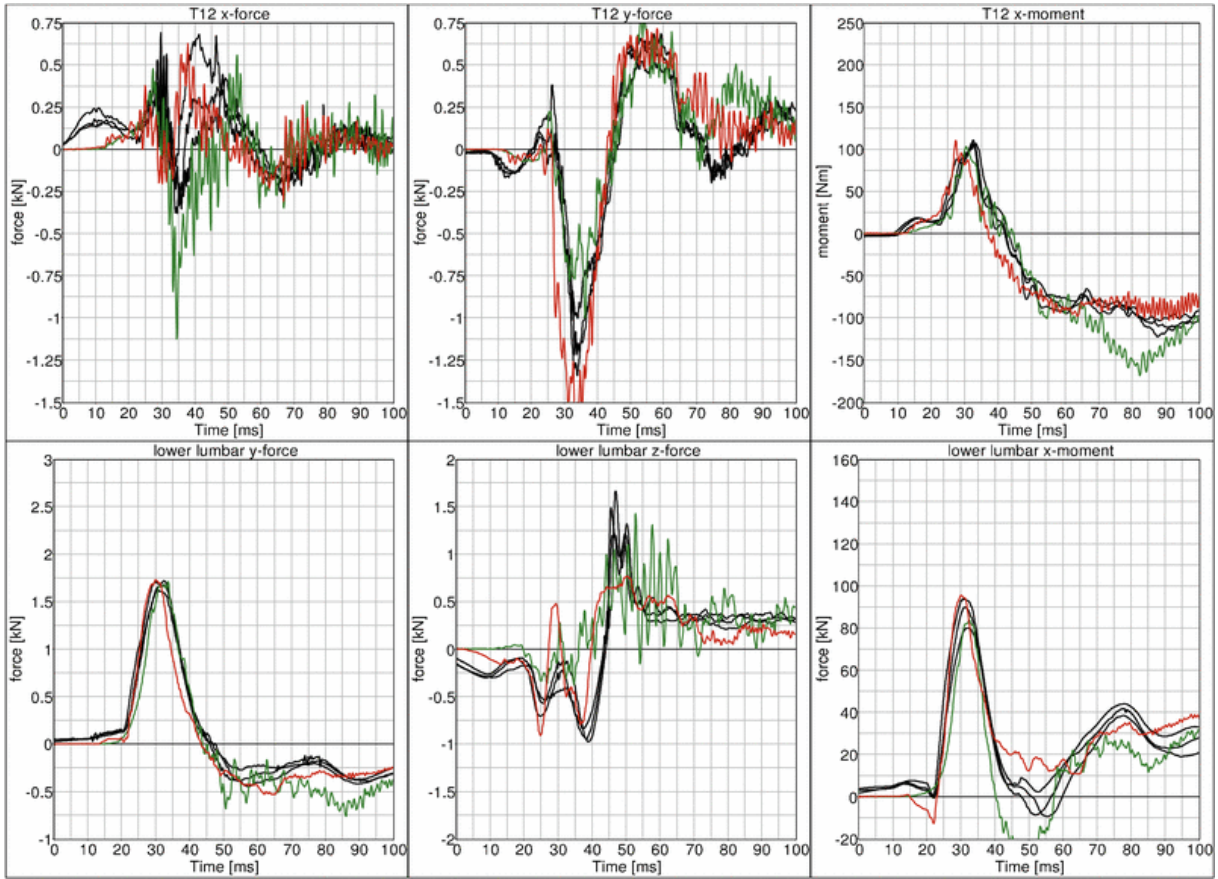

10.4 Shoulder Certification test of ES-2

Boundaries:

- Pendulum impacting the shoulder (Figure 39)
- Impact speed: 4.3 m/s
- Mass: 23.4 kg
- Arms in 40 degree position
- The pendulum hits the shoulder at the center pivot axis of the arm

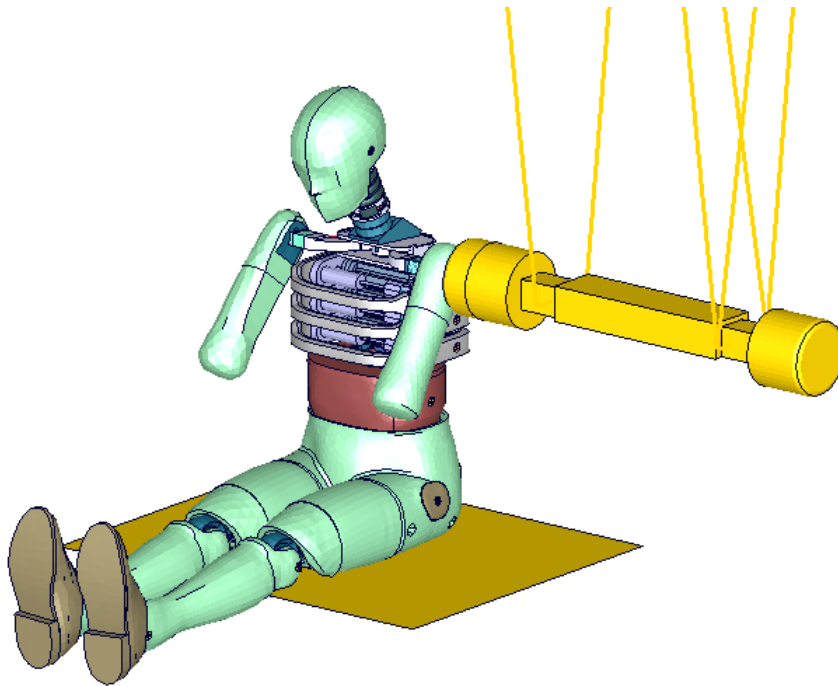
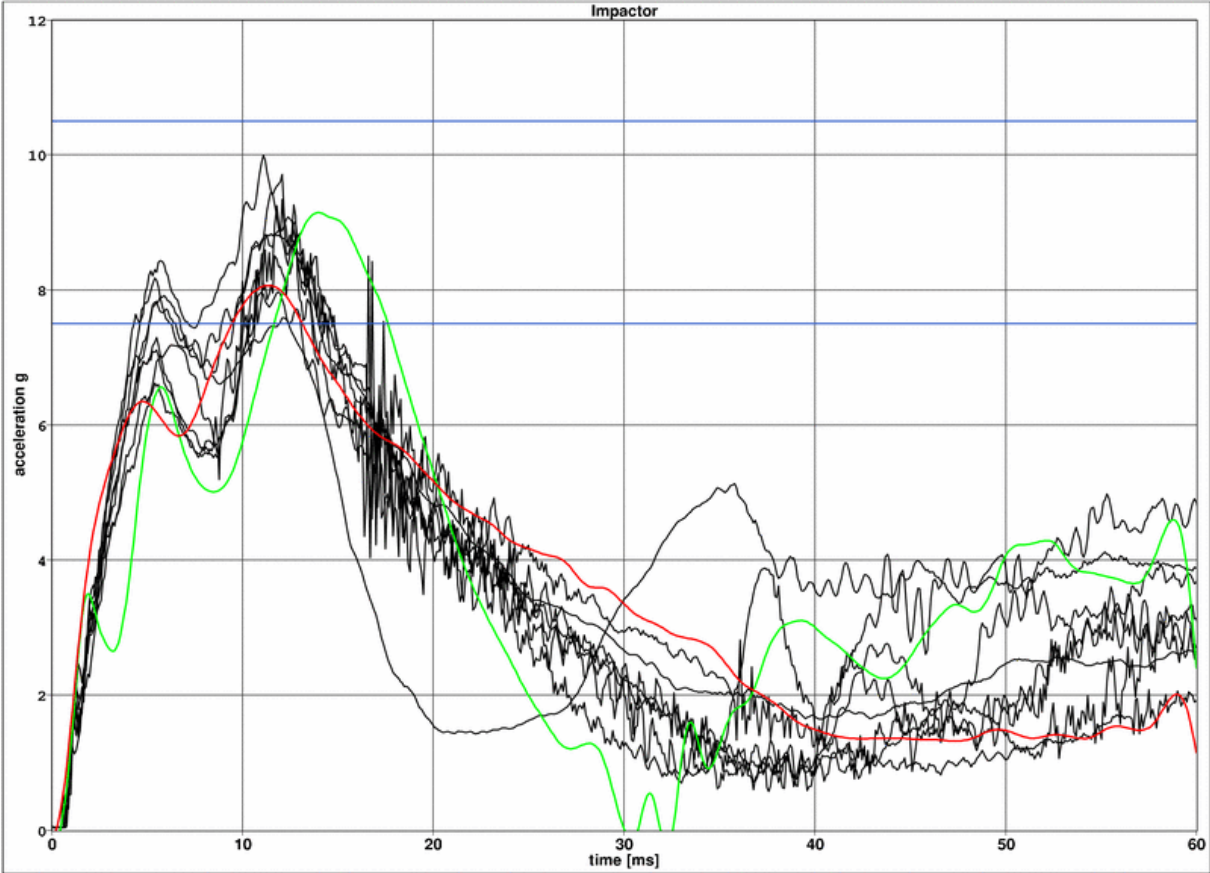

Figure 39: ES-2 shoulder certification test setup

10.4.1 Results



10.5 Abdomen Certification test of ES-2

Boundaries:

- Pendulum impacting the abdomen (Figure 40)
- Impact speed: 4.0 m/s
- Mass: 24.4 kg
- Arms in 90 degree position
- A wooden block is mounted in front of the pendulum

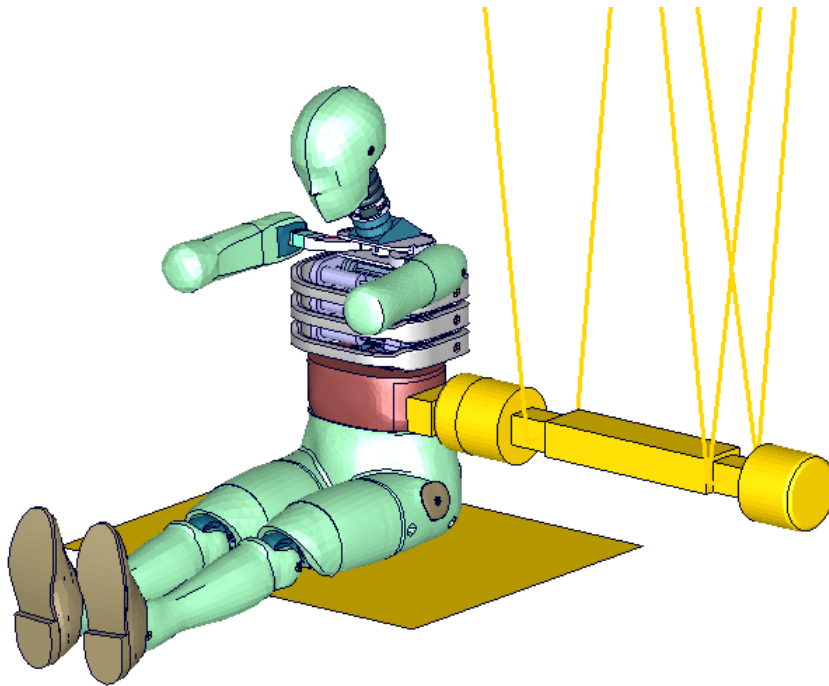
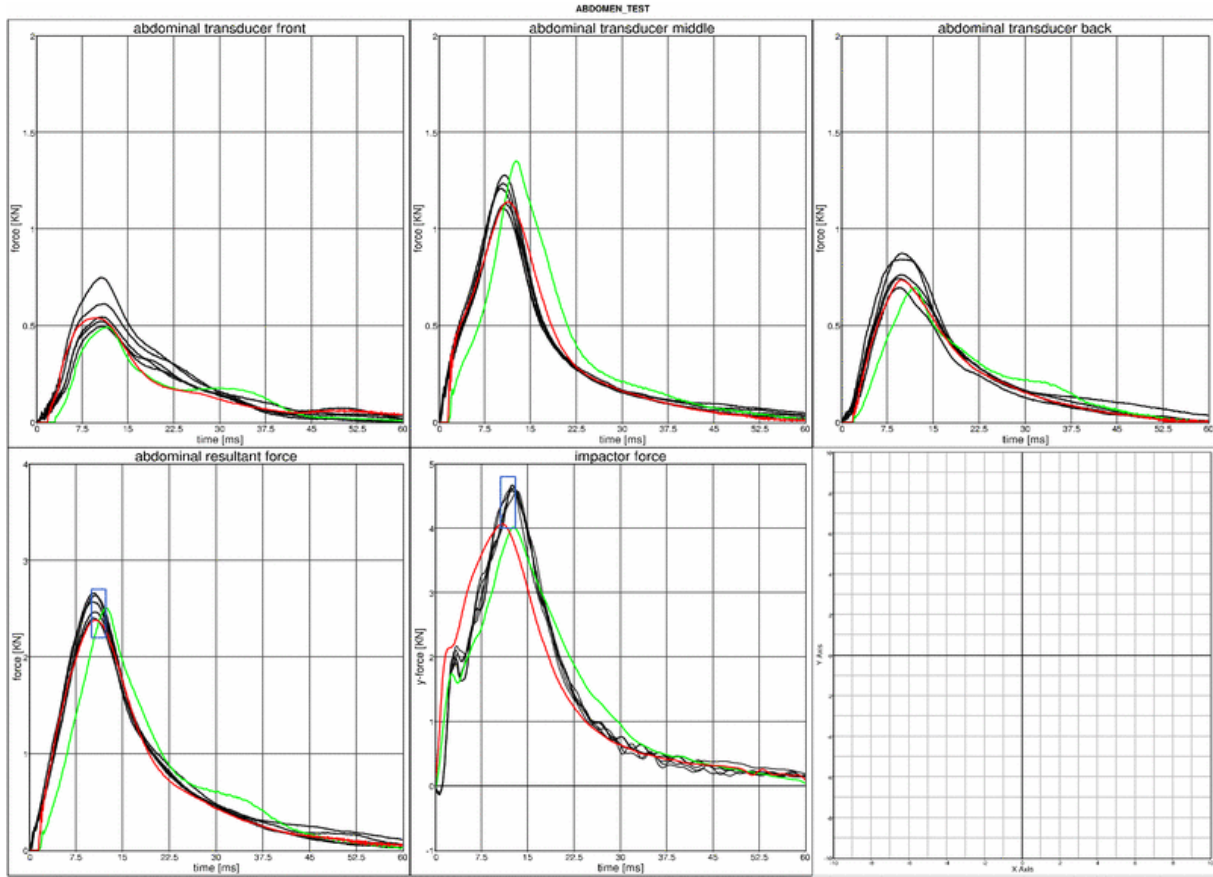

Figure 40: ES-2 abdomen certification test setup

10.5.1 Results



10.6 Pelvis Certification test of ES-2

Boundaries:

- Pendulum impacting the pelvis (Figure 41)
- Impact speed: 4.3 m/s
- Mass: 23.4 kg
- Arms in 90 degree position
- The pendulum impact is aligned to the H-point

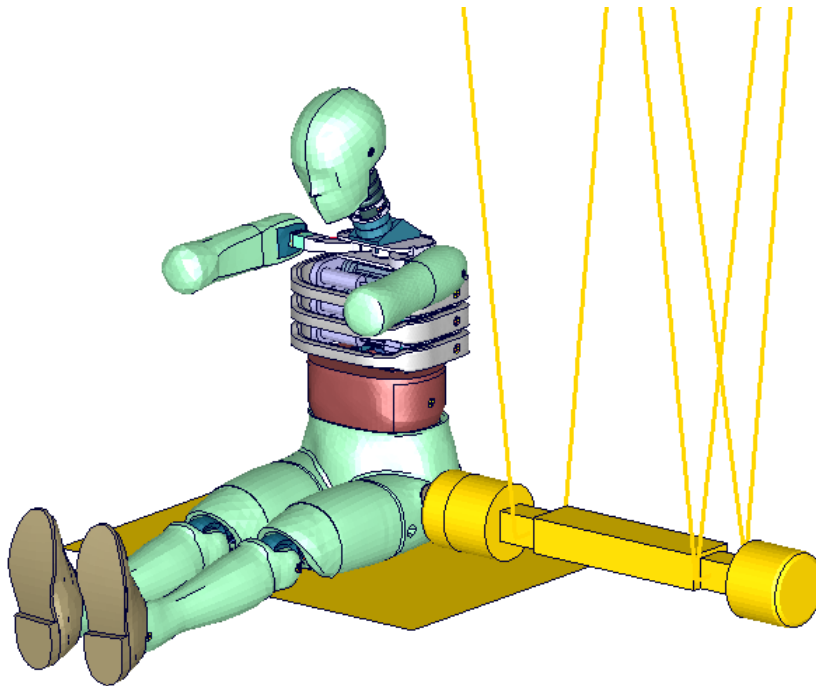
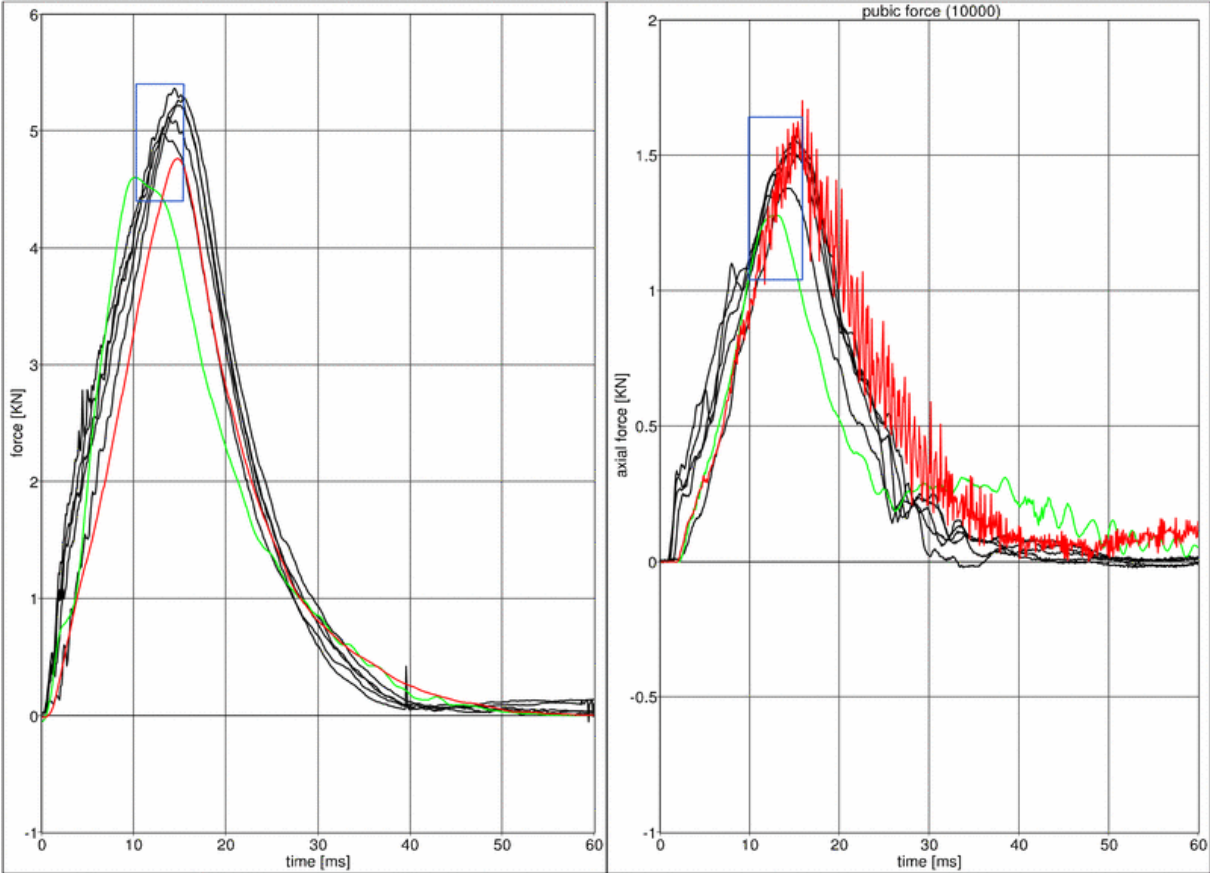

Figure 41: ES-2 pelvis certification test setup

10.6.1 Results



10.7 Performance under SMP & MPP

The results of two different runs on SMP and MPP machines are depicted below.

SMP results obtained on:

- Platform: Intel-Xeon64 Linux Workstation (4 CPUs)
- OS-level: CentOS 5
- Version: ls971 R4.2.1 revision 53450 (product ID 53929) single precision

MPP results obtained on:

- Platform: Linux Cluster Intel-Xeon64 (96 CPUs)
- OS-level: Red Hat 4
- Version: mpp971 R4.2.1 revision 53450 (product ID 64994) single precision

Boundaries:

- Rigid barrier (Figure 36)
- Speed: high and low speed
- Arms in 40 degree position
- Orthogonal impact

10.7.1 Results at low speed

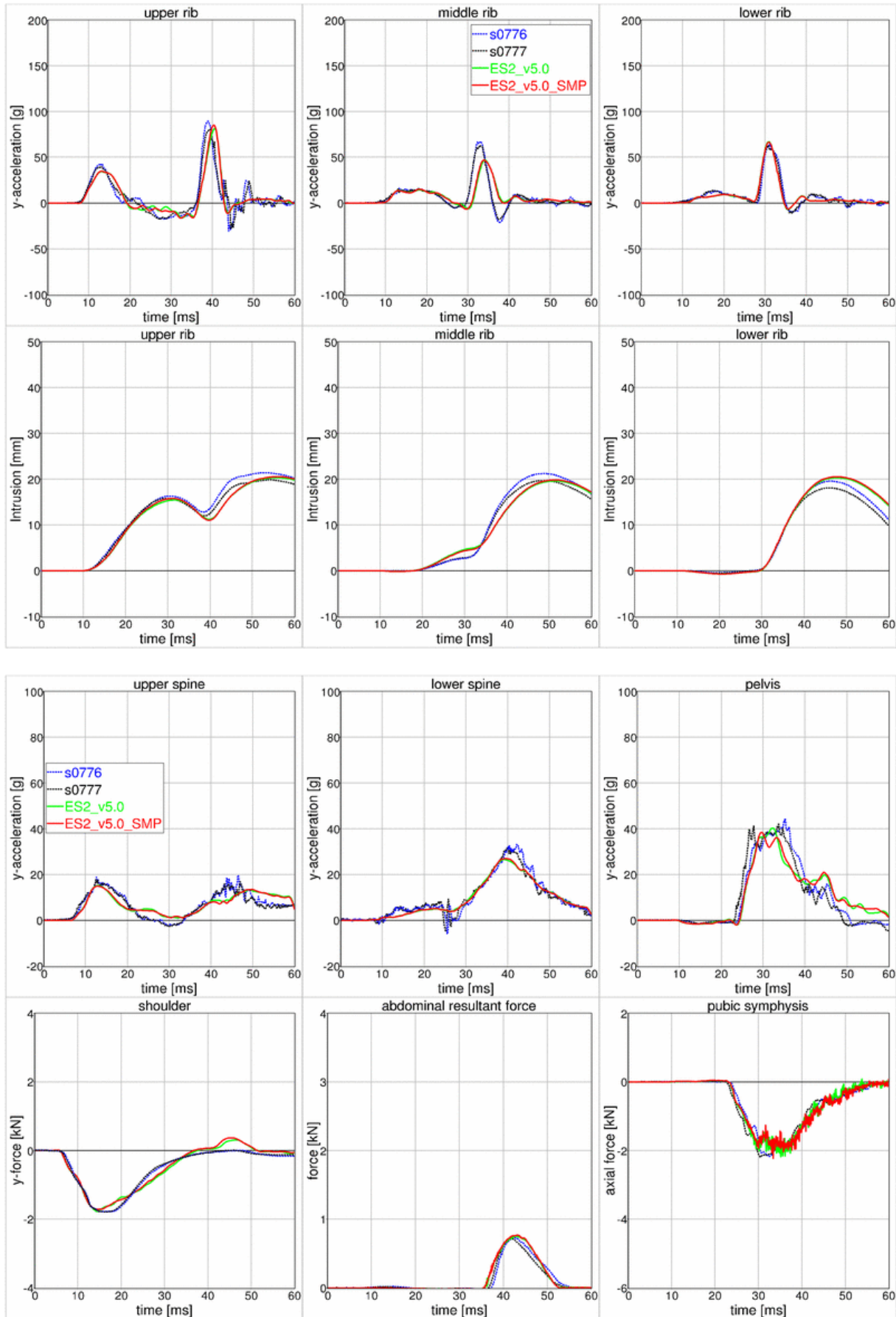

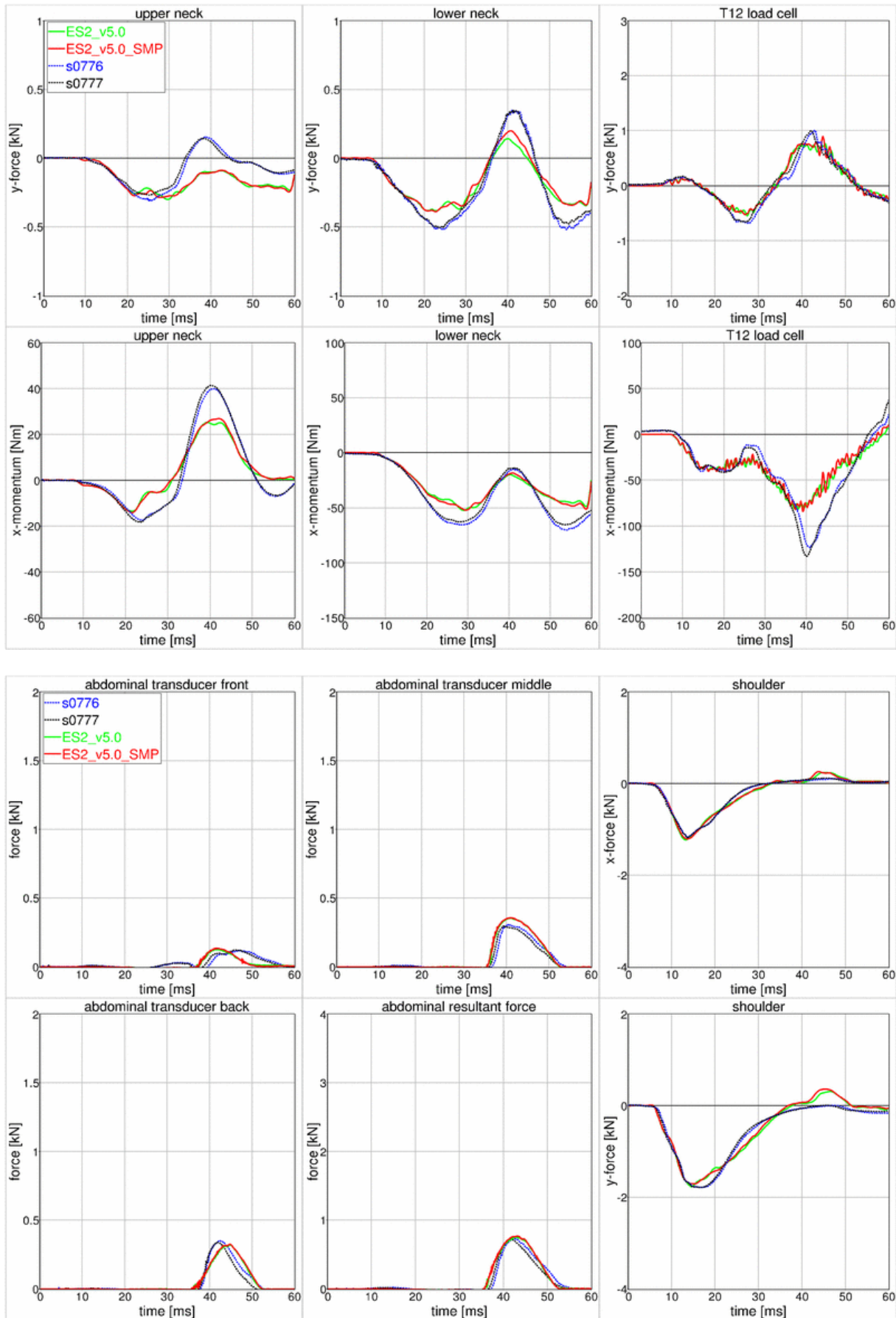

10.7.2 Results at high speed

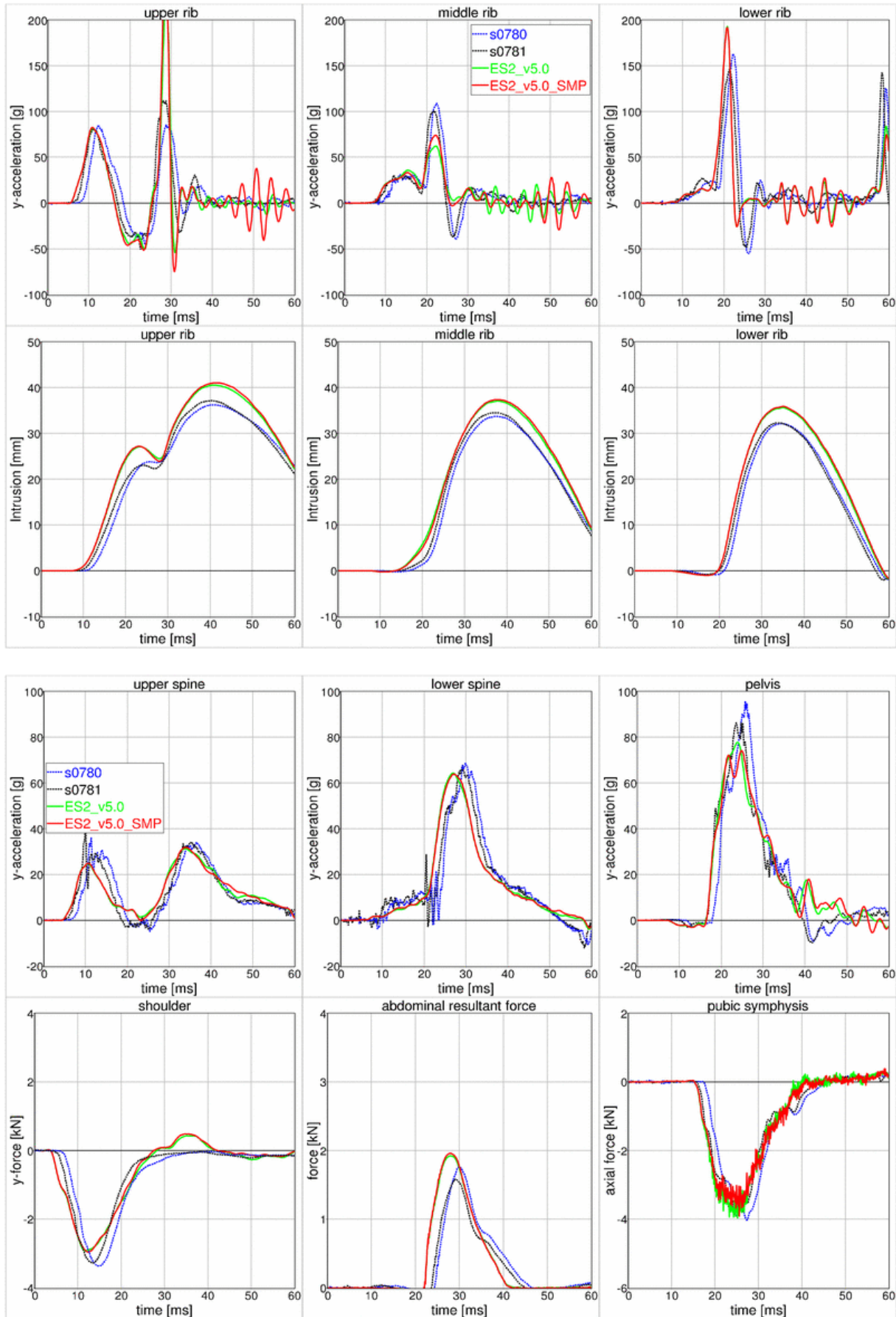

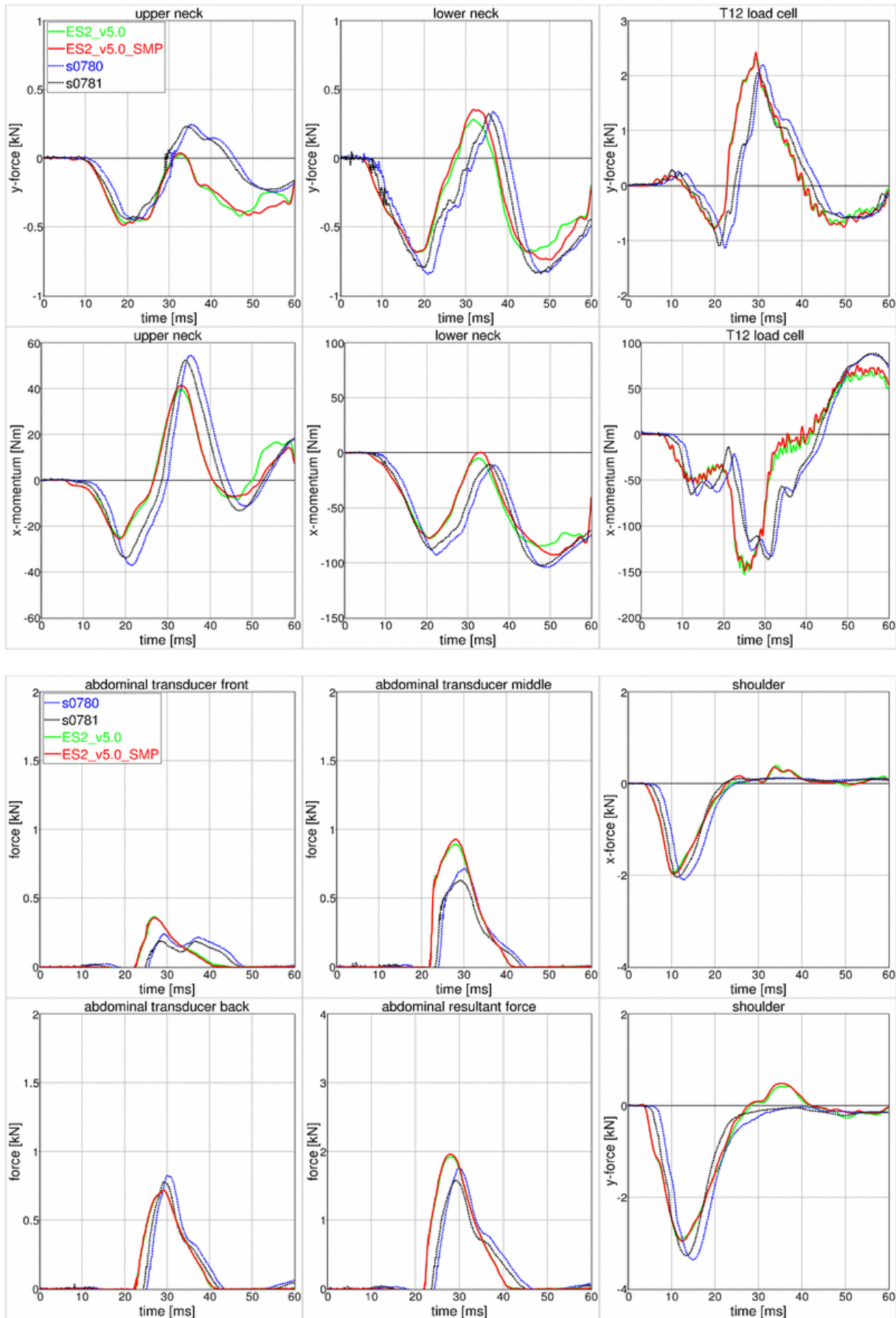

10.8 Additional test of ES-2re – Pendulum at 90 degree without jacket and arm

Boundaries:

- Pendulum at 90 degrees (Figure 42)
- Speed: low and high velocity
- Pendulum mass: 24.1 kg
- No jacket and left arm is not attached

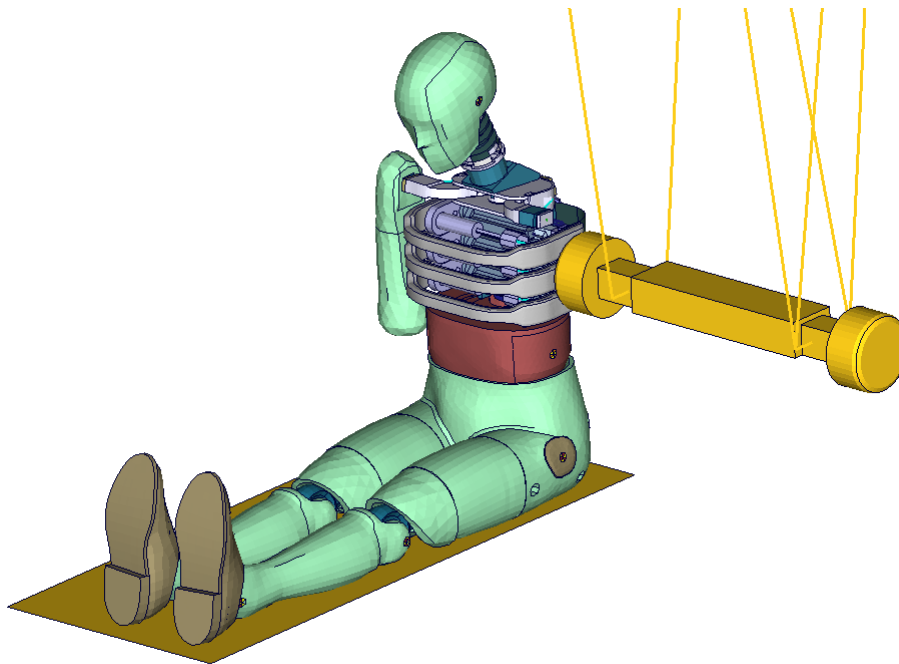
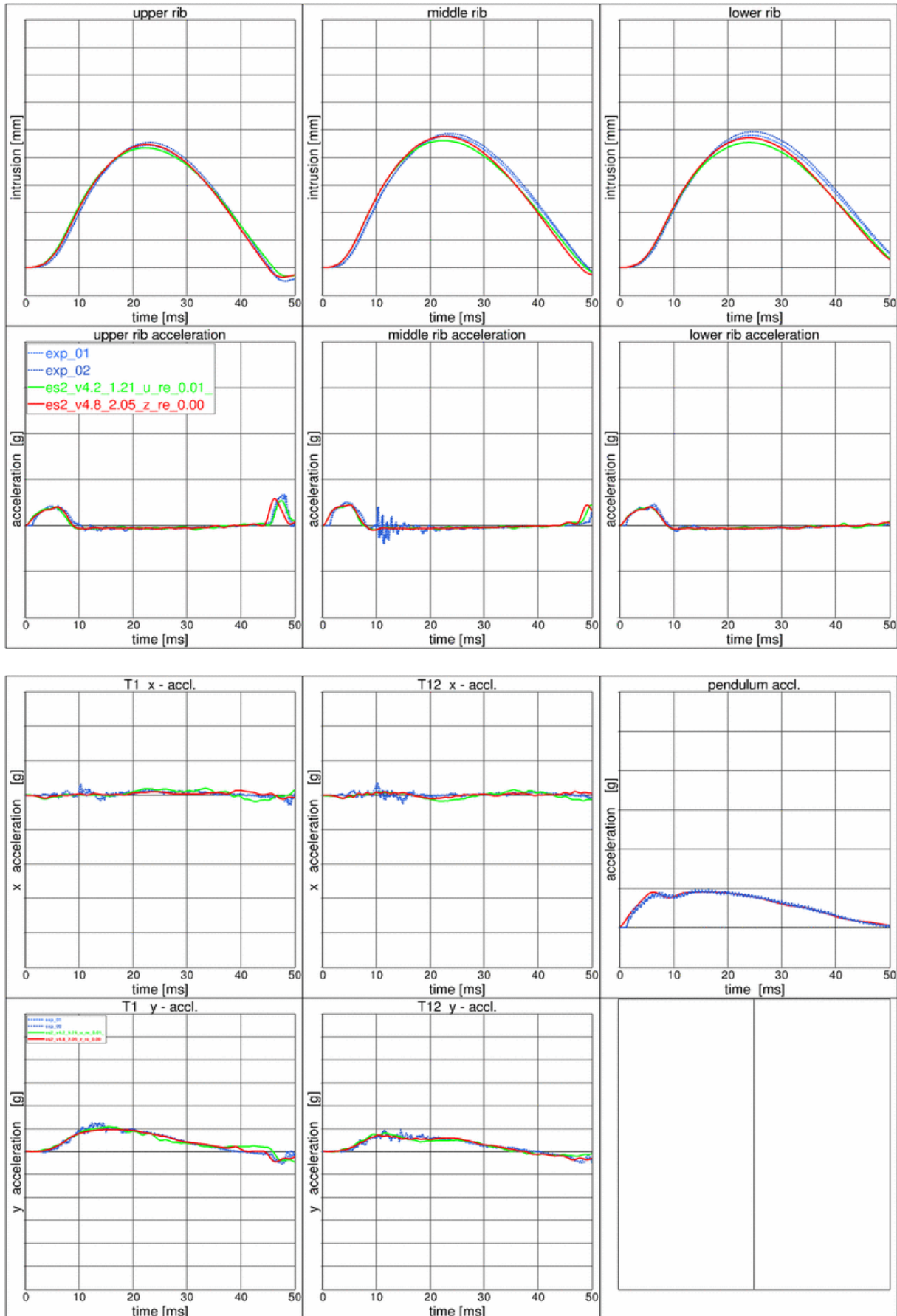
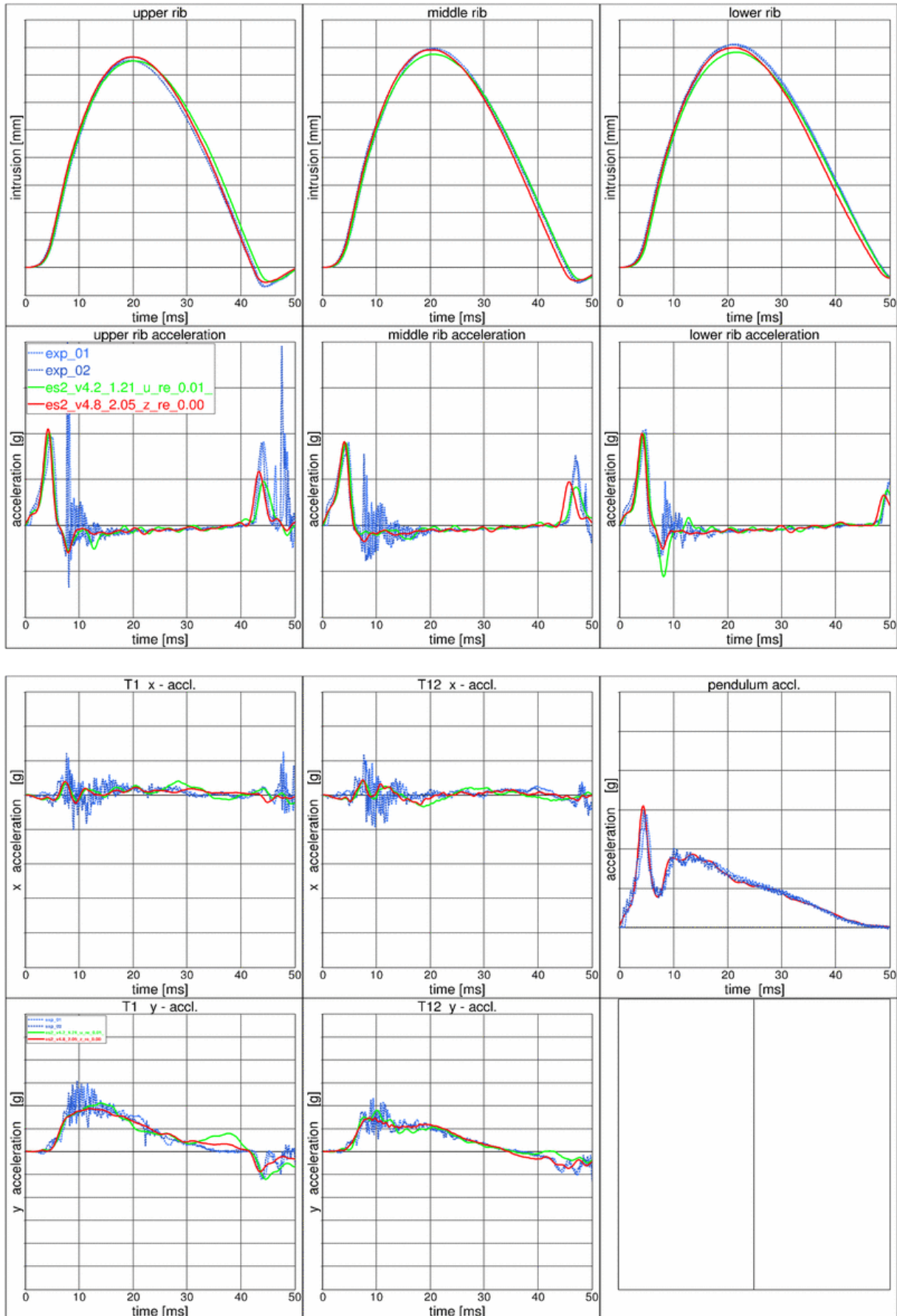

Figure 42: Pendulum impacting the ribs at 90 degrees; without arm and jacket

10.8.1 Results at low velocity



10.8.2 Results at high velocity



10.9 Additional test of ES-2re – Pendulum at 45 degree without jacket and arm

Boundaries:

- Pendulum at 45 degrees (Figure 43)
- Speed: low and high velocity
- Pendulum mass: 24.1 kg
- No jacket and left arm is not attached
- An ensolite foam is mounted in front of the pendulum

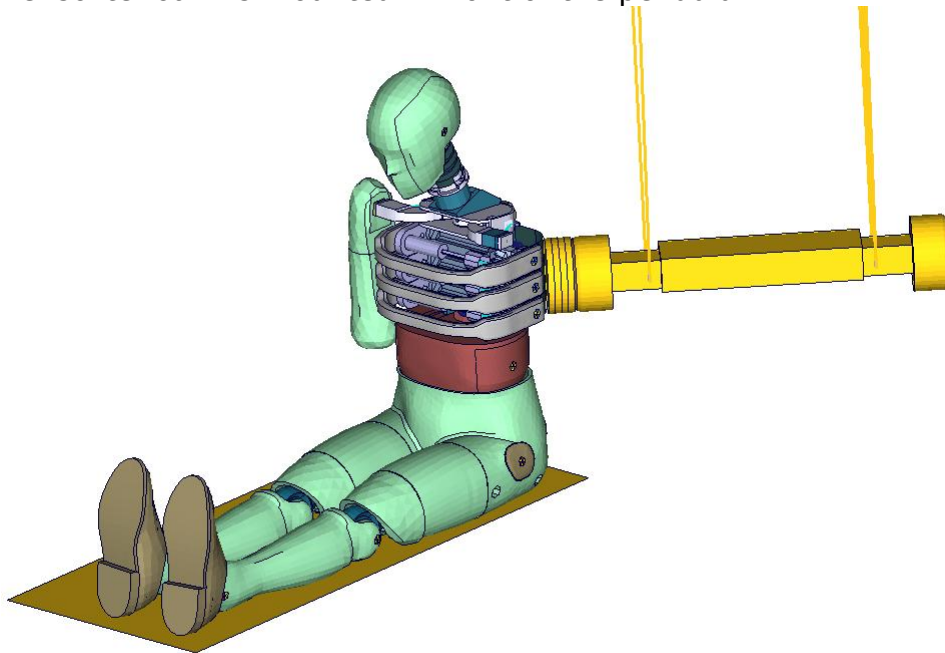
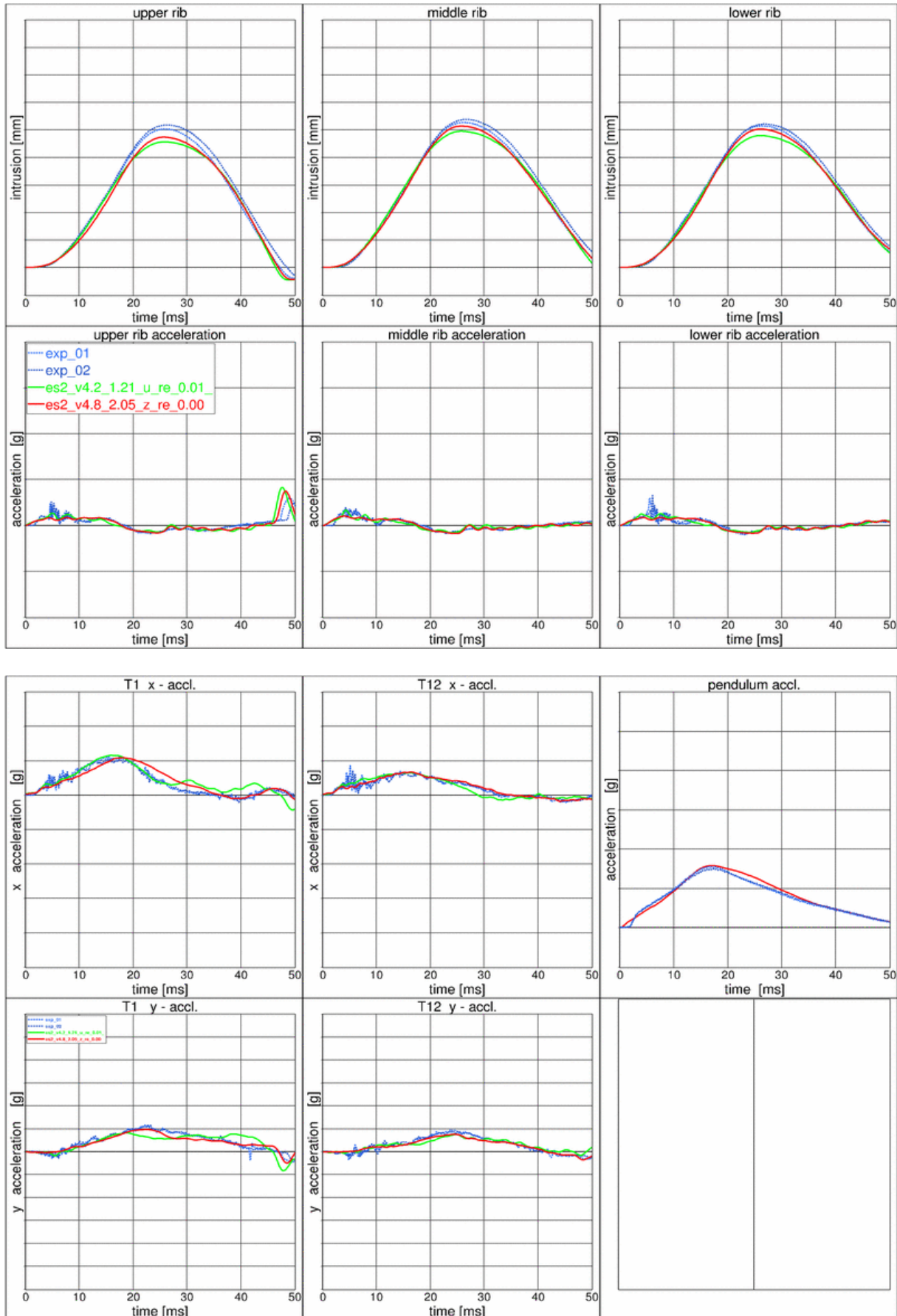
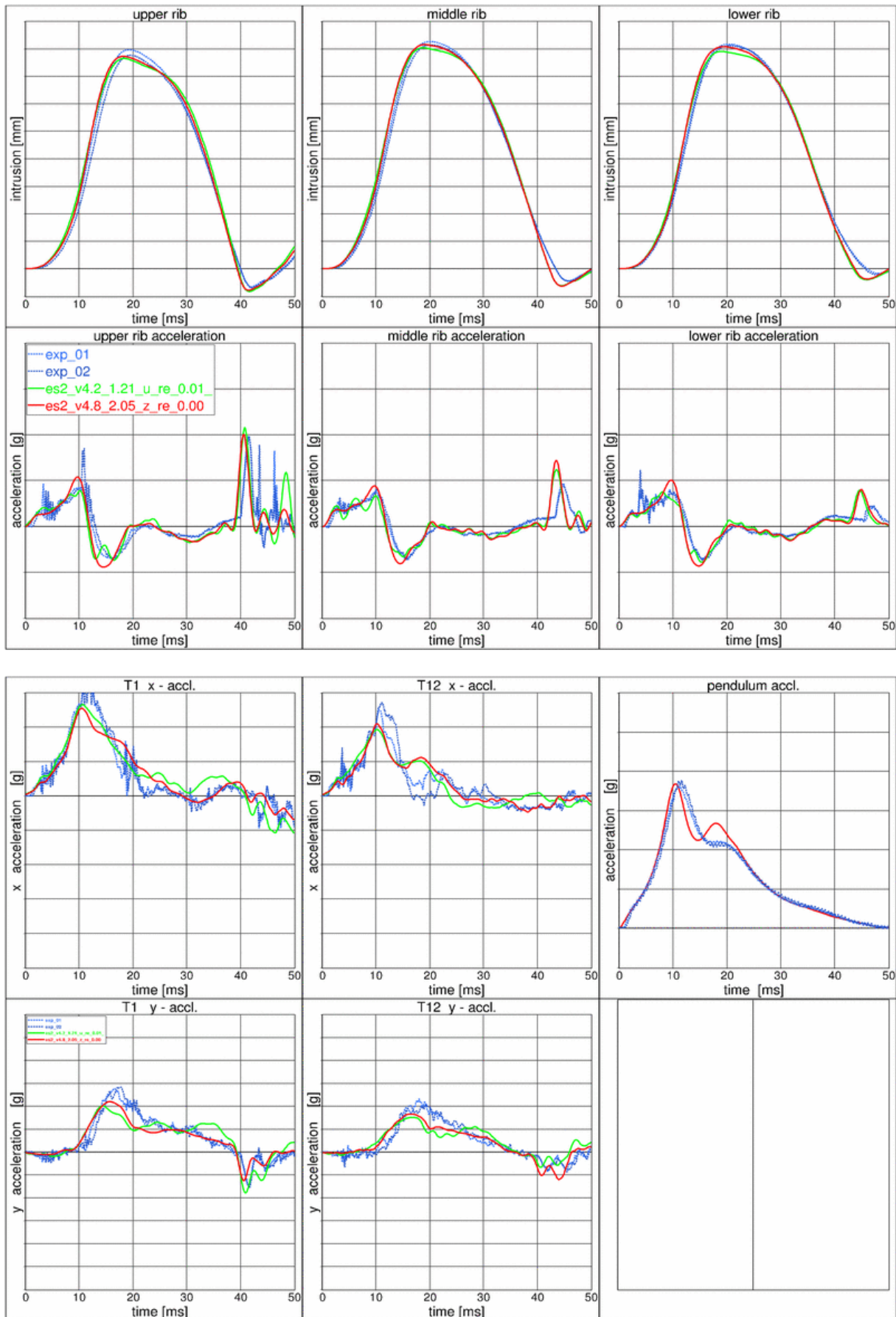

Figure 43: Pendulum impacting the ribs at 45 degrees; without arm and jacket

10.9.1 Results at low velocity



10.10 Results at high velocity



10.11 Additional test of ES-2re – Pendulum at 45 degree without jacket and arm

Boundaries:

- Pendulum at 45 degrees (Figure 44)
- Speed: high velocity
- Pendulum mass: 24.1 kg
- Arms in 90 degree position
- The pendulum hits the rib extension at an angle of 45 degrees
- ES-2 is equipped with arms and jacket

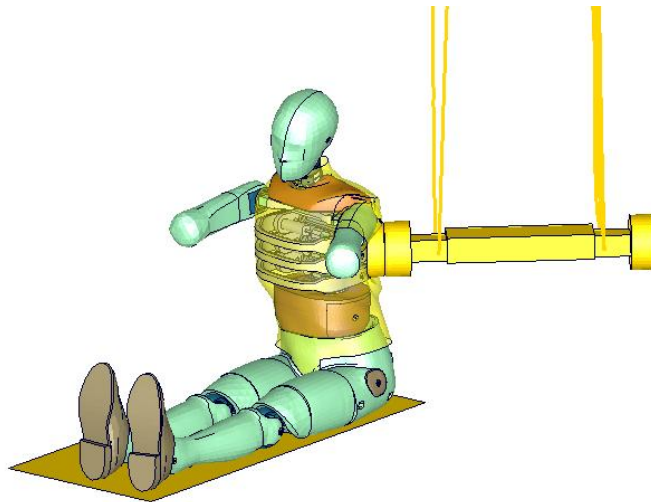

Figure 44: Pendulum impacting the ribs at 45 degrees; with arm and jacket

10.11.1 Results

