

Automating and organizing the optimization process using ANSA - LSOPT- META. A bumper optimization case study

Georgios Korbetis
BETA CAE Systems S.A., Thessaloniki, Greece

Summary:

As the optimization techniques are used more extensively during the product development life cycle, the use of a tool that organizes the definition of an optimization process becomes essential. The set up of combined shape and parameter optimization is possible through ANSA functionality and the use of the Morphing Tool.

Besides the optimization problem set up, ANSA functionality intends to provide an efficient way to check the model validity and element quality before the optimization is run. Since the simulation models become even larger, it is important to apply element quality improving algorithms in a non time consuming way.

The direct coupling of ANSA with LSOPT provides a powerful and user friendly tool for setting up the optimization problem. The use of META as a post processor offers an efficient way to extract the responses, even when complicated actions and calculations are needed.

Keywords:

morphing, shape, parameter, optimization, task management.

1 Introduction

The present work describes the recommended practice for defining an optimization problem using ANSA as a pre-processor. Special functionality of the ANSA Task Manager Tool enables the definition of such problems while minimizes the use of scripting and need for customization. The connection between ANSA and LS-OPT becomes an easy task since the new enhancements in LS-OPT provide a special pre-processing deck for ANSA. As an alternative way of extracting responses for the optimization problem, the use of Meta Post is introduced.

The case study that is used is a crash test simulation of a rear bumper according to the standards of Allianz Zentrum für Technik GmbH. Shape and parameter optimization is applied to the bumper FE-Model, searching for the optimum solution that ensures maximum energy absorption.

The shape of the bumper is modified with the use of ANSA's Morphing Tool. The Morphing is driven by special entities which parameterize the shaping and makes it possible to connect the shaping with the design variables. Re-meshing and quality improvement functions are applied in the optimization sequence to ensure that the model will reach specific quality standards after shaping. Detailed model reports are created for every iteration giving to the user an overview of the whole process. The quality improvement and model report functionalities are controlled from the optimization sequence that is defined through the Task Manager

2 Defining the optimization problem

The case study that is presented here is the optimization of a crash test simulation of a car rear bumper. The specifications of the crash test are prescribed from the Allianz Zentrum für Technik GmbH and more specific the "AZT Crashreparaturtest Heck" standard. The FE-Model of the test is courtesy of Alcan Ltd. (Figure 1.).

A rigid barrier impacts the bumper with a velocity of 16 [Km/h] and an impact angle of 10 degrees. The mass of the barrier is 1000 [kg] as the mass of the vehicle is 1514,53 [Kg].

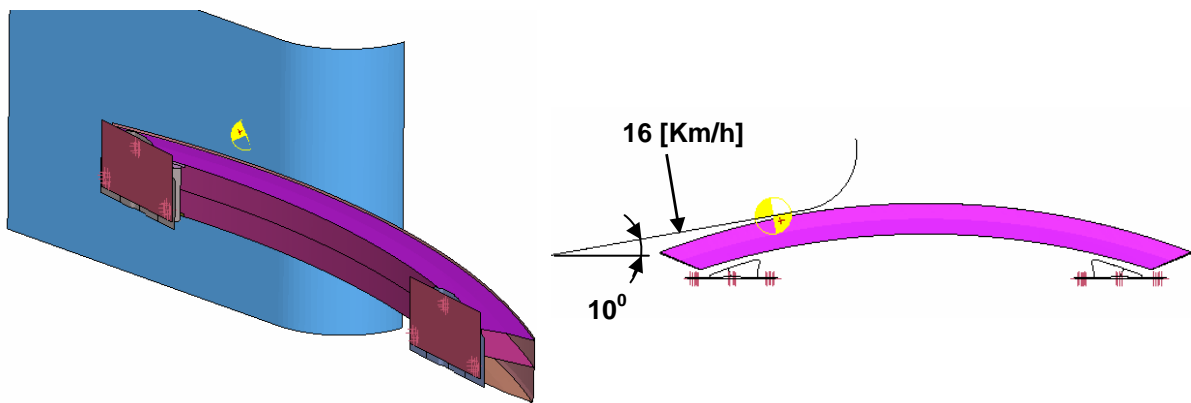

Fig. 1. The bumper initial model (courtesy of Alcan Ltd.)

The impact energy should be absorbed through the plastic deformation of the traverse reinforcement of the bumper. To achieve the maximum energy absorption, the force that the bumper receives should be as even as possible for the whole crash time and close to the maximum allowable level. Therefore, the objective is to minimize the sum of the squared errors between the impact force of the simulation and a prescribed constant impact force (120 [KN]). Four measurements of the simulated force take place along to the crash time which leads to the calculation of the sum of squared errors as follows:

$$MSE_Force = \sqrt{\sum_{i=0}^3 (F(t_i) - 120)^2}$$

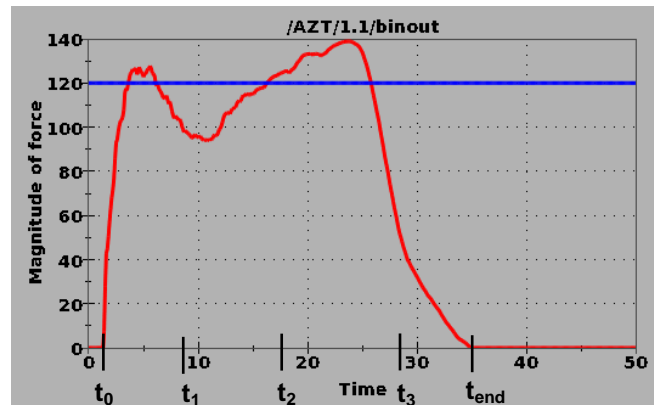

Fig. 2. MSE_Force calculation

A second objective is to minimize the model weight. The objective function consists of the above objective parameters which, after normalization is:

$$\min f = (0.1 * mass + 0,227 * MSE_Force)$$

The constraints that are used for the optimization problem are:

- The maximum force that appears during the simulation which, should not exceed the 125 [kN].
- The height of the bumper's front part, which must be bigger than 60 [mm] (see Figure 3).

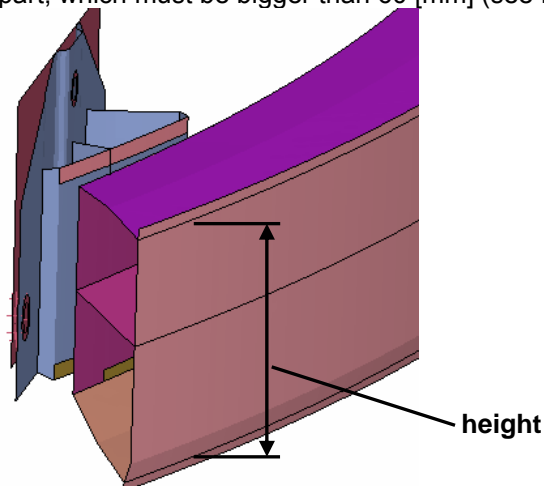

Fig. 3. Bumper's height constraint

Combined shape and parameter optimization will be applied to the model. Four design variables are used to control model's shape. These design variables modify the height of the front and middle parts of the bumper as shown at the Figure 4. The design variables for the shaping are shown in the Table 1.

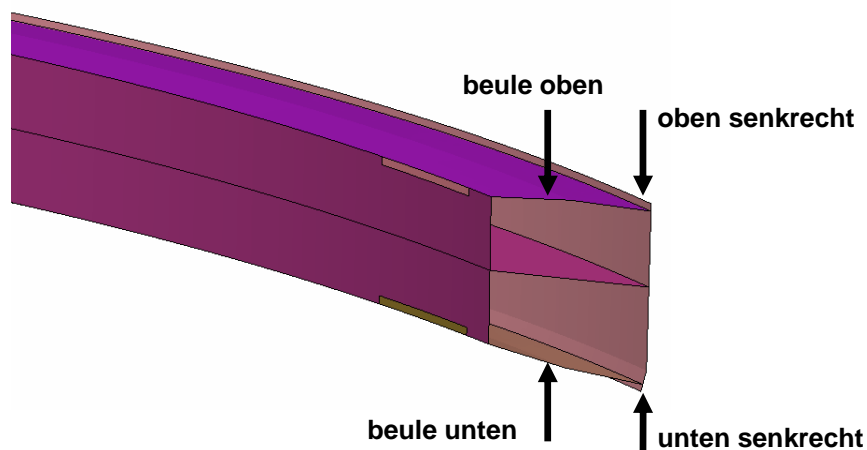

Fig. 4. Design Variables for shaping

Design Variable	Initial Value	Lower Bound	Upper Bound
<i>oben_shenkrecht</i>	0	-50	0
<i>unten_shenkrecht</i>	0	-50	0
<i>beule_oben</i>	0	-50	0
<i>beule_unten</i>	0	-50	0

Table 1.

Five more design variables control the shell thickness of the model parts, as shown at the Figure 5. and Table 2.

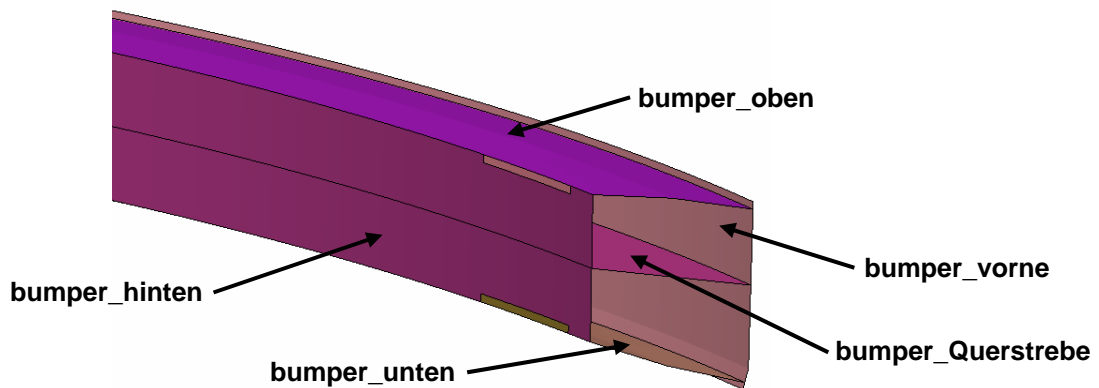

Fig. 5. Design Variables for shell thickness

Design Variable	Initial Value	Lower Bound	Upper Bound
<i>bumper_vorne</i>	2.5	2	10
<i>bumper_oben</i>	2.5	2	10
<i>bumper_hinten</i>	2.5	2	10
<i>bumper_unten</i>	2.5	2	10
<i>bumper_Querstrebe</i>	2.5	2	10

Table 2.

2.1 Morphing Boxes and Parameters

The FE-Model shaping can be achieved with the use of the ANSA Morphing Tool. This tool provides many ways of shaping and ensures smooth and controllable results. Morphing Boxes, special entities of this tool, are created around the model. The shape of the Morphing Boxes can be modified in several ways and handled by Control Points. The model surrounded from the Boxes, follow the modification thus the shaping takes place.

Since the model is symmetrical to the XZ plane, only the half of the Boxes have to be defined on the one side of the model. On the opposite side linked Morphing Boxes are created by mirroring the original ones. In this way, every morphing action on the original Boxes will be duplicated to the symmetry link Boxes ensuring symmetrical morphing (see Figure 6).

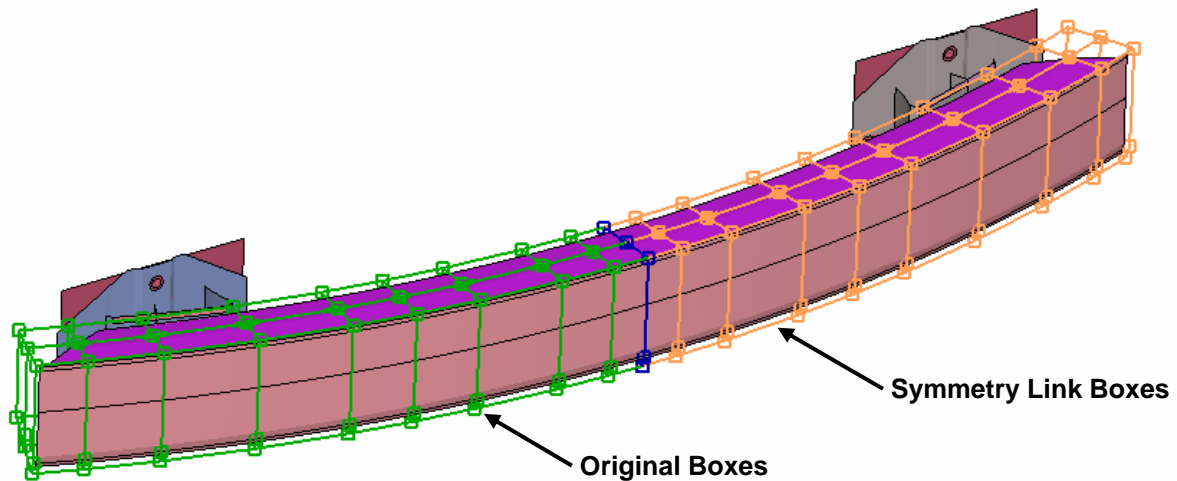

Fig. 6. Symmetry Link Morphing Boxes

Since the morphing process should be connected with LS-OPT, the design variables must drive the process. Therefore the modification of the Boxes shape is controlled parametrically by special entities, the Morphing Parameters which later on will be associated with the design variables.

In Figure 7 the selected Control Points of the Boxes are moved along to the Z axis driven by one Morphing Parameter. Changing the parameter's value leads to the shaping of the model (Figure 8).

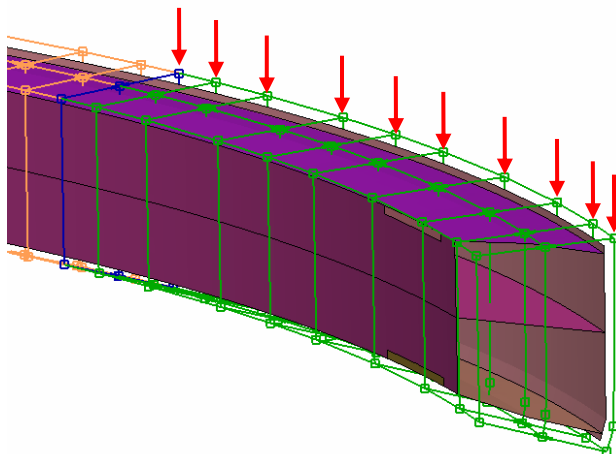

Fig. 7. The initial shape

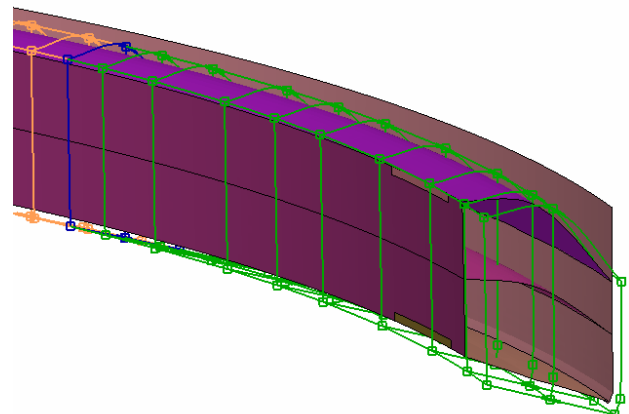

Fig. 8. The modified shape

2.2 ANSA Parameters

The shell thickness of the model parts should be controlled also with design variables so there is the need to drive the shell thickness in a parametric way. Almost any value on an ANSA card is possible to be defined parametrically using the ANSA Parameter entity. ANSA Parameters are entities which can be used to transfer values or make calculations among ANSA cards. One ANSA Parameter should be defined for every model part. The shell thickness (T1) of each SECTION_SHELL card (Figure 10.) is substituted by the relative ANSA Parameter (Figure 9.). Then, the ANSA Parameter will be connected with the proper design variable. As a result the thickness value will be always equal to the current value of the design variable.

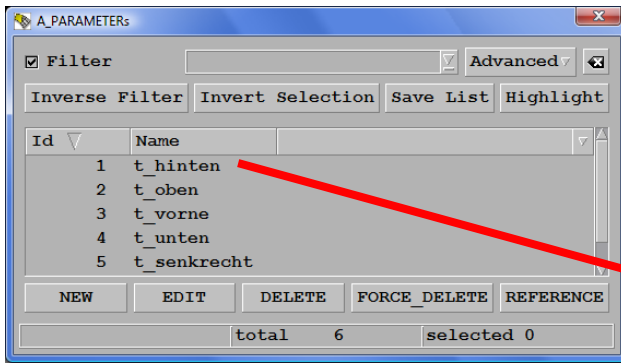

Fig. 9. ANSA Parameters

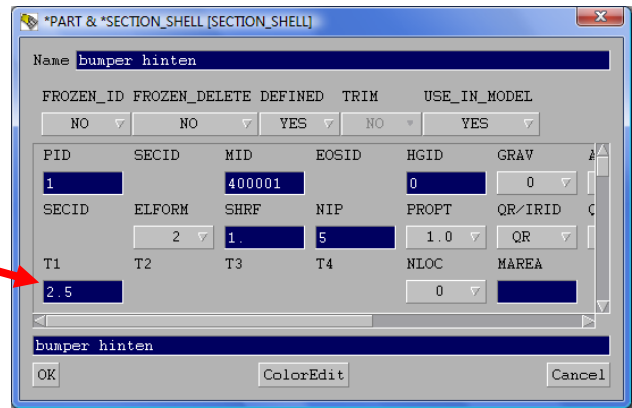

Fig. 10. The SECTION_SHELL card

2.3 Defining the Task Manager sequence

The Task Manager is a powerful tool of ANSA which can organize and automate the set up of specific pre-processing tasks, like frontal or side crash, for a given solver. The Task Manager is also able to set up an optimization problem for parametric optimizers with the use of a special entity, the Optimization Task (Figure 11.).

The Optimization Task can organize the sequence of all the actions that must be executed in an optimization loop. Design variables are defined here and connected with the Morphing Tool, ANSA Parameters or with user's script to perform complicated actions. Once the sequence is defined, the Task Manager is able to check if every entity is properly defined and help the user to complete the case. In addition, the know-how of setting up the problem can be easily transferred in other cases or shared among the users.

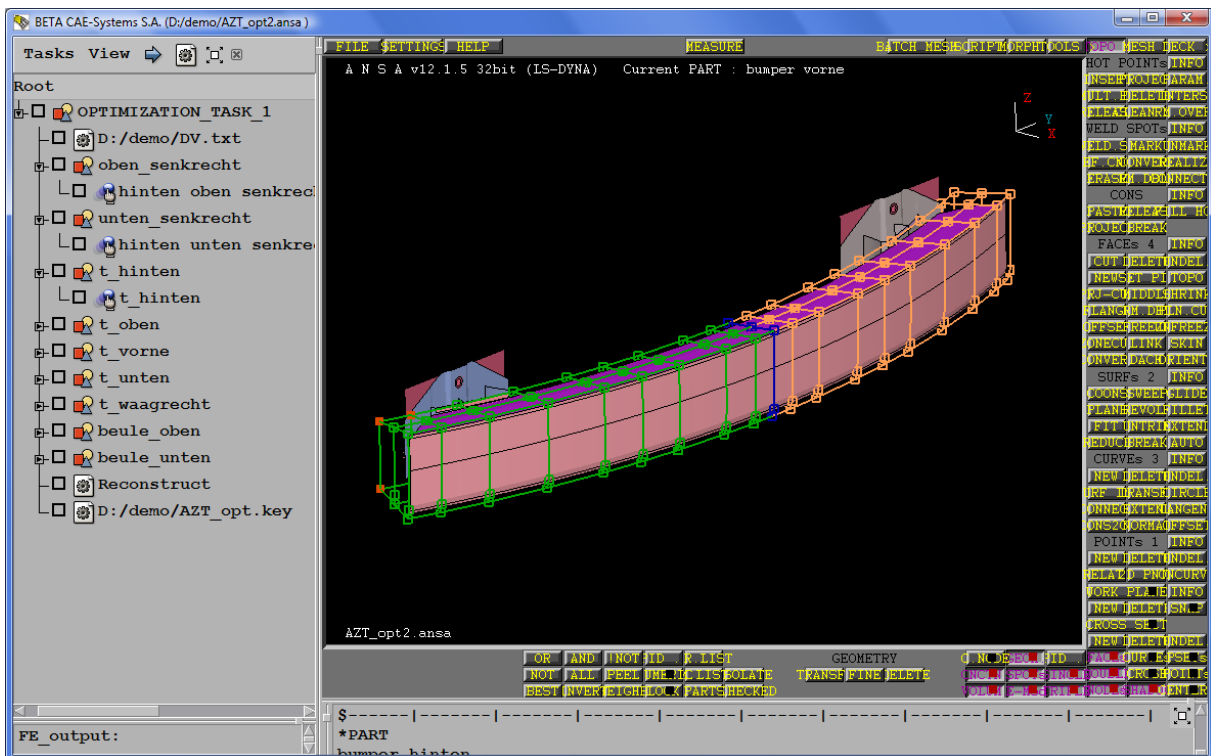

Fig. 11. The Optimization Task

The definition of the optimization problem starts with the set up of the design variables that will control the model. The type of the values and the bounds of the design variables are defined in special cards as shown at the Figure 12. In this example the value type of all design variables is *Real* and the range is defined from an upper and a lower value.



Fig. 12. The Design Variable card

The next step is to connect the design variables with the already defined morphing parameters. Now any change in the current value of the design variables will drive the morphing parameters and hence the morphing action (Figures 13, 14).

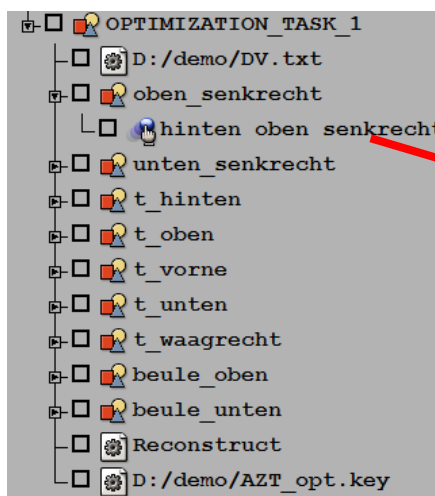

Fig. 13. Design Variables

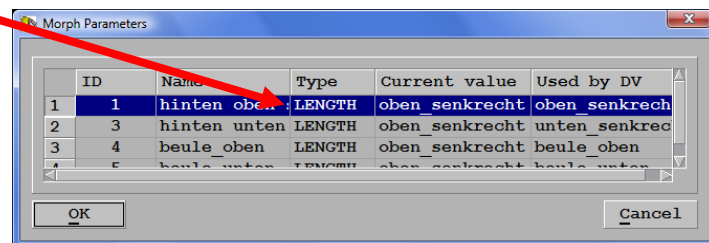

Fig. 14. Morphing Parameters

The design variables that control the shell thickness of the model parts are connected with the defined ANSA Parameters (Figures 15, 16).

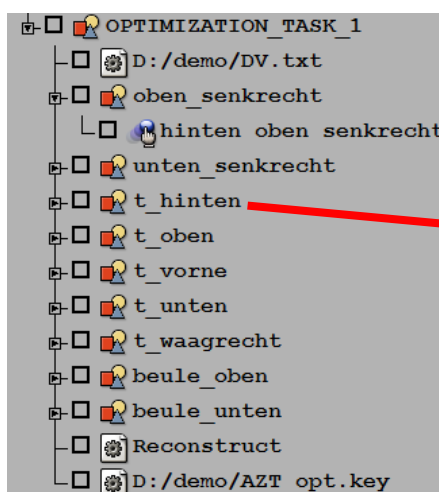

Fig. 15. Design Variables

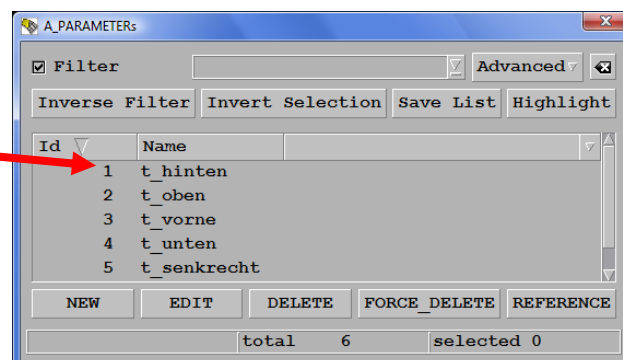

Fig. 16. ANSA Parameters

2.4 Input / Output

The communication among ANSA and LS-OPT is achieved with the use of two ascii files which are defined in the Optimization Task. The first file is the DV File which contains the design variables, their bounds and current values. Using this file the optimizer can easily extract the design variables values (Figure 17). The optimizer will change the current values and the model will be updated in every optimization loop. The second file, the FE Output, contains the FE-Model that will be the input for the solver. The FE-Model is output at the end of the optimization sequence so it contains all the actions that took place in this sequence.

# DESIGN VARIABLES						
#-----#						
# ID	DESIGN VARIABLE NAME	TYPE	RANGE	CURRENT VALUE	MIN VALUE -->	MAX VALUE STEP
#-----#						
1,	oben_senkrecht,	REAL,	BOUNDS,	-50.	-50.,	0.
3,	unten_senkrecht,	REAL,	BOUNDS,	-50.,	-50.,	0.
5,	t_hinten,	REAL,	BOUNDS,	2.5,	2.,	10.
6,	t_oben,	REAL,	BOUNDS,	2.5,	2.,	10.
7,	t_vorne,	REAL,	BOUNDS,	2.5,	2.,	10.
8,	t_unten,	REAL,	BOUNDS,	2.5,	2.,	10.
10,	t_waagrecht,	REAL,	BOUNDS,	2.5,	2.,	10.
11,	beule_oben,	REAL,	BOUNDS,	-20.,	-20.,	0.
12,	beule_unten,	REAL,	BOUNDS,	-20.,	-20.,	0.

Fig. 17. The Design Variables File

2.5 Checking model validity

Before connecting the Optimization Task to LS-OPT and running the problem, it is very important to check for any failure of the model which may occur for different combinations of the design variable values. This check will guide the user to apply realistic bounds for the design variables. Also the user can decide to apply specific functionality in the optimization loop which will check the model and improve its quality. In this example, extreme values to the design variables lead to failed elements due to minimum element length and crash time step (Figure 18).

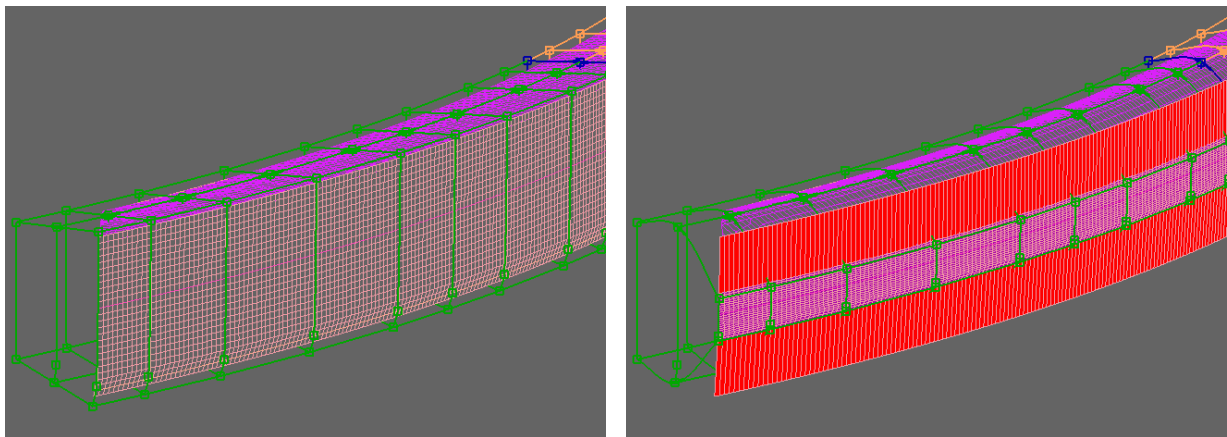

Fig. 18. Failed elements due to morphing in extreme values

A special functionality of the Optimization Task makes possible the simulation of the model through the values of the design variables. Also animation and video recording capability can easily give an overview of the model behavior. After connecting the Optimization Task with the optimizer, a detailed report can be created, in every iteration, to locate any model failure during the optimization run (Figure 19). Any information about the elements quality is reported here according to the defined quality criteria. So by running even a simple DOE the user can check the model for any combination of the design variables. This report can be easily defined as a Task Item in the Optimization sequence.

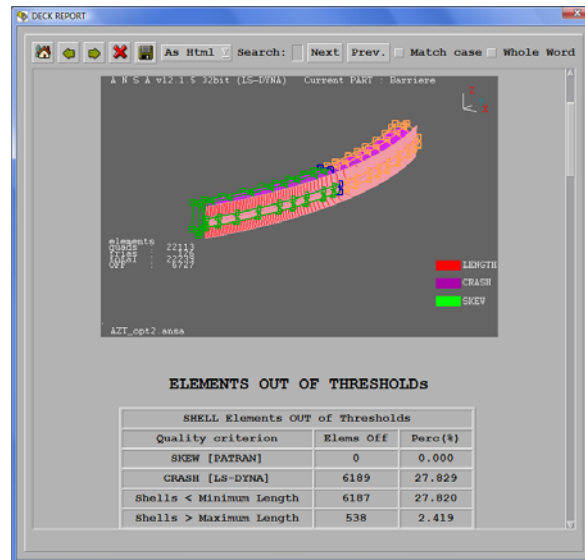

Fig. 19. The Model Report

2.6 Improve model quality

After the morphing process, it is possible that some element areas become distorted and the element quality poor. To improve the model quality the *Reconstruction* functionality is applied on the model. This function re-meshes the FE-Model to fulfill pre-defined quality criteria and it can be defined as a Task Item in the optimization sequence.

In a simple case the *Reconstruction* function can be applied to the whole model. However, this could be time consuming for a relatively large model. Additionally, there are cases that the reconstruction on particular parts it's not desirable since this action can cause renumbering of nodes and elements. To overcome this problem, the *Reconstruction* function is possible to be applied on specific element sets, parts or properties. The *Reconstruction* can be also applied only on failed elements and save even more time for every iteration. In this case the reconstruction algorithm is applied on the failed elements and a number of element zones around them. This ensures the smooth transition between the failed and non-failed elements (Figure 20).

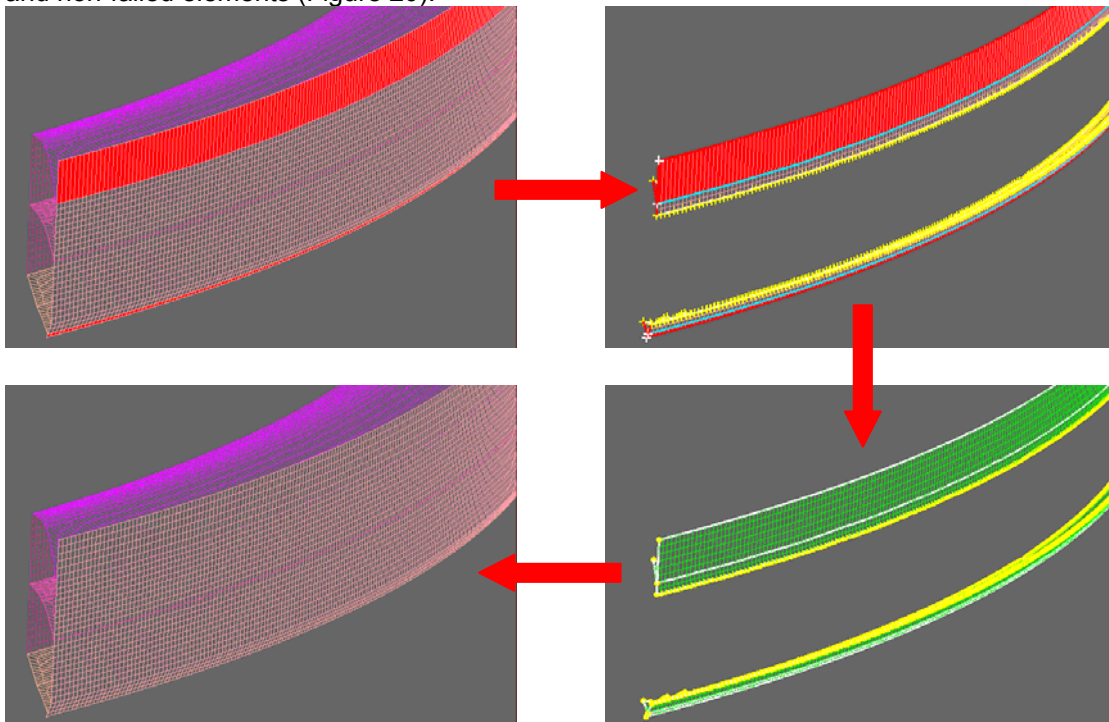

Fig. 20. Reconstruction on failed elements

2.7 Extracting responses from the FE-Model

During the set-up of the optimization sequence in ANSA, it's also possible to define some responses for the optimization problem. This is possible when no solver is needed for the responses extraction. Information of the model like mass, center of gravity, volume and area can be easily extracted through the Model Report. The Model Report is defined as a Task Item in the optimization sequence and creates a text file with the needed information (Figure 21.). Then, the optimizer can extract and use the response data.

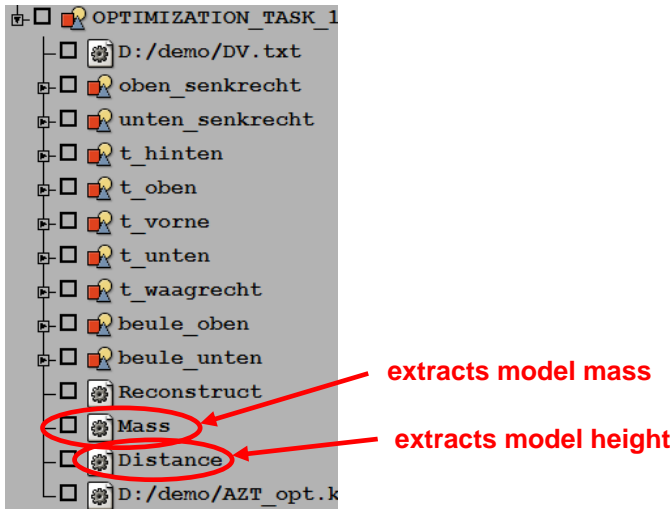

Fig. 21. Extracting responses from the Optimization Task

Moreover, measurements of the model like length, distance and angle can be used as responses. In this example the height of the bumper should be bigger than 60 [mm]. A *Measurement* entity is defined for this reason (Figure 22.). A Task Item in the optimization sequence can export the measurement value to an ascii file so the optimizer can extract the response.

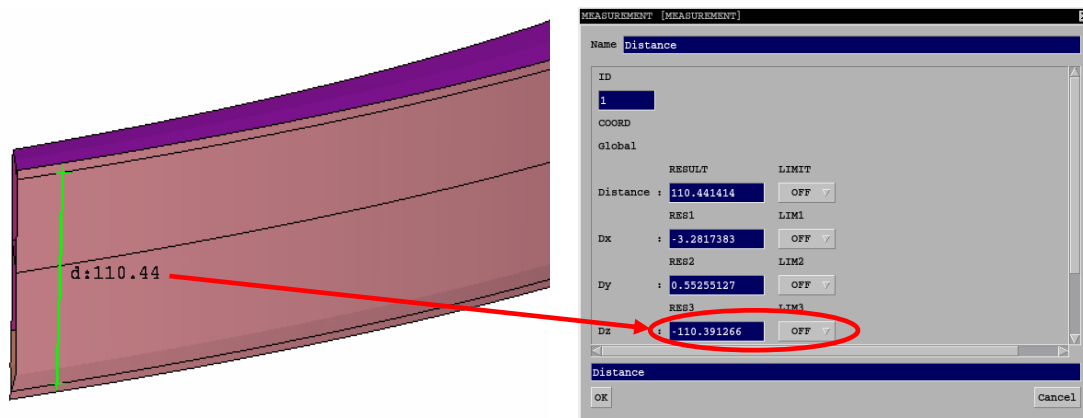

Fig. 22. The Measurement entity

3 Connect ANSA with LS-OPT

The optimization sequence that is defined in ANSA can be easily connected to LS-OPT since the latter provides special functionality for this connection. The coupling of the two programs does not require any scripting or customization which makes the coupling fast and versatile.

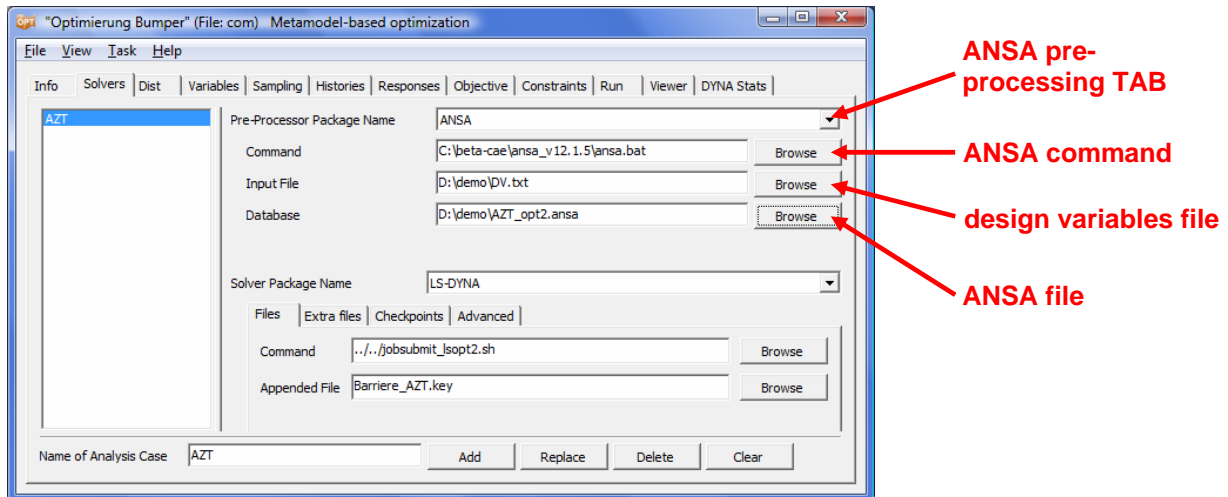

Fig. 23. The ANSA TAB in LS-OPT

In the special pre-processing Tab of LS-OPT for ANSA the user can define the ANSA command, the ANSA file and the design variables file (Figure 23.). All the information contained in the design variables file is recognized from LS-OPT so the design variables with the correct name, type, bounds and initial values are defined automatically as shown at the Figure 24.

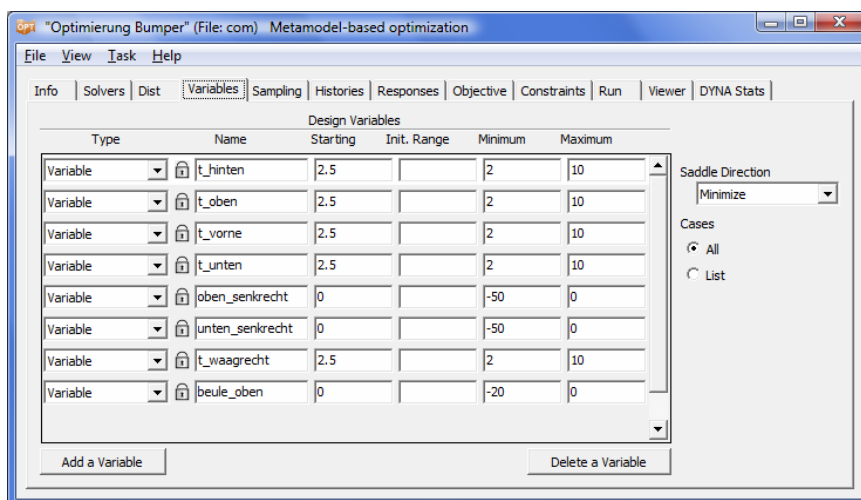

Fig. 24. The design variables in LS-OPT

4 Using Meta Post to extract responses

Meta Post is capable of reading ascii or binary results of many solvers. It can also create sophisticated reports and statistics. In the optimization problem Meta Post can be connected to an optimizer and work in batch mode to extract responses. The responses can be saved in specific ascii files where can be easily accessed from the optimizer. Multiple result files can be read in and complicated calculations are available to extract the desired responses. Taking advantage of the graphics interface of Meta Post makes the calculation of responses an easy process as every action that the user makes is recorded in a session file. The created session file is connected to the optimizer and repeats automatically the recorded actions in every optimization loop.

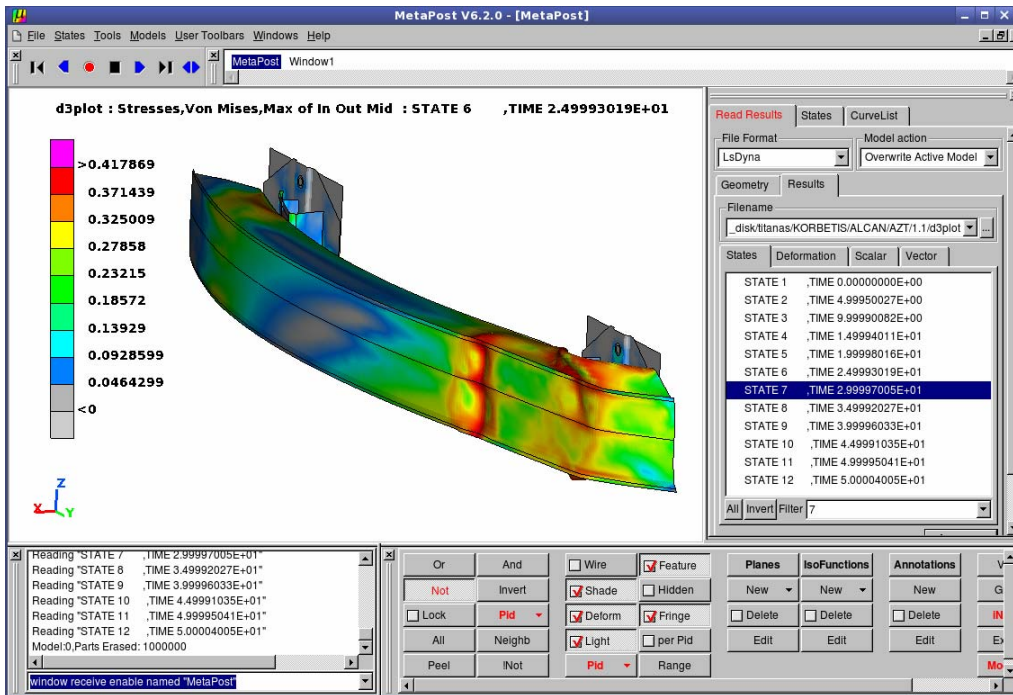

Fig. 25. The Meta Post graphics interface

In this example the MSE_Force which will be used as objective parameter will be calculated through Meta Post. The steps for this process are:

- Read in the rforc Slave Contact curve from the binout file
- Create a second curve which represents the predefined contact force with constant value 120 [KN]
- Calculate the MSE_Force using the Annotation Tool and a user defined script
- Export the MSE_Force value to a text file where LS-OPT can extract it.

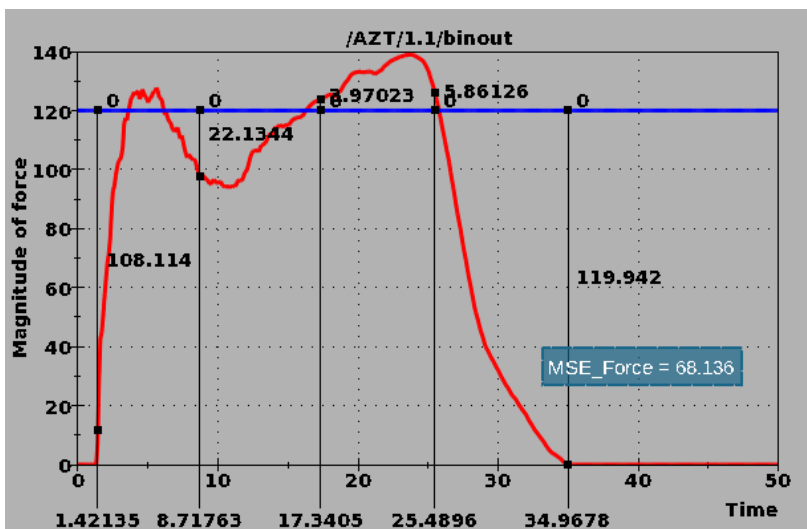

Fig. 26. The calculation of MSE_Force

By using a simple script Meta Post can be connected to the Responses Tab of LS-OPT. In every optimization loop Meta Post will run and it will calculate the MSE_Force.

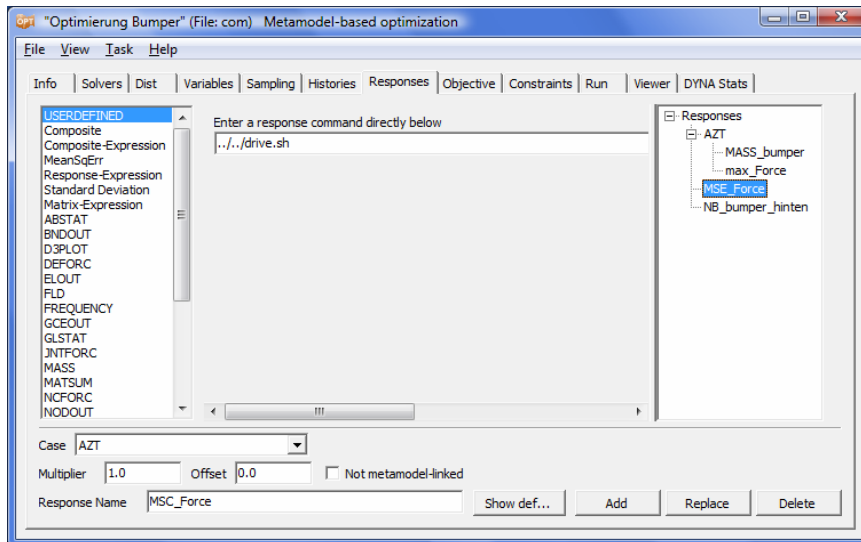

Fig. 27. Connecting Meta Post to LS-OPT

5 Summary

The close coupling of ANSA pre-processor and LS-OPT provides a powerful tool for design optimization.

The pre-processing of the optimization problem can be organized and automated by the Task Manager functionality of ANSA. The connection of the Morphing Tool with the Task Manager offers a powerful interface for the shape optimization set up. Re-meshing and quality improvement functions can be applied in local areas of the FE-Model to repair element quality after morphing. Additionally, detailed reports inform the user for the model validity at any stage of the optimization process.

Meta Post post-processor can be coupled to LS-OPT and extract responses in an efficient and user friendly way.

6 Literature

- [1] LS-DYNA KEYWORD USER'S MANUAL VOLUME I, "LSTC", 2007, 2206
- [2] LS-OPT User's Manual, A Design Optimization and Probabilistic Analysis Tool for the Engineering Analyst, "LSTC", 2007, 449
- [3] ANSA v12.1.5 User's Guide, "BETA CAE Systems S.A.", 2008, 1314
- [4] ANSA v12.1.5 Optimization with ANSA, "BETA CAE Systems S.A.", 2008, 49
- [5] μ ETA Post Processor version 6.2.0, "BETA CAE Systems S.A.", 2008, 546
- [6] M. Feuerstein, K. Witowski, H. Müllerschön "Optimization of a Crash Management System Considering Multiple Load Cases Using ANSA and LS-OPT" "DYNAmore" 2008
- [7] G. Korbetis "Shape and parameter optimization with ANSA and LS-OPT using a new flexible interface" "DYNAmore", 2007, 12

