

Multi-Scale Modeling of Crash & Failure of Reinforced Plastics Parts with DIGIMAT to LS-DYNA interface

L. Adam, A. Depouhon & R. Assaker

e-Xstream engineering S.A.. 7, Rue du Bosquet. B-1348 Louvain-la-Neuve. Belgium.

Correspondence:

Phone : +32 (0)10 866425

Fax : +32 (0)10 840767

Email : Roger.Assaker@e-xstream.com

Web site : www.e-Xstream.com

Summary:

This paper deals with the prediction of the overall behavior of polymer matrix composites and structures, based on mean-field homogenization. We present the basis of the mean-field homogenization incremental formulation and illustrate the method through the analysis of the impact properties of fiber reinforced structures. The present formulation is part of the DIGIMAT [1] software, and its interface to LS-DYNA, enabling multi-scale FE analysis of these composite structures.

Impact tests on glass fiber reinforced plastic structures using DIGIMAT coupled to LS-DYNA allow to analyze the sensitivity of the impact properties to the polymer properties, fibers' concentration, orientation, length ... For such impact applications the material models used for the polymer matrix are usually based on nonlinear elasto-viscoplastic laws. Failure criterion can also be defined in DIGIMAT at macroscopic and/or microscopic levels and can be used to predict the stiffness reduction prior to failure (i.e. by using the First Pseudo Grain Failure model). These failure criterion can be expressed in terms of stresses or strains and use strain rate dependent strengths.

Finally, the interface to LS-DYNA, available for the MPP version, will be used to run such multi-scale FE simulations on Linux DMP clusters. The application will thus involve:

- LS-DYNA MPP to solve the structural problem.
- DIGIMAT-MF as the material modeler.
- DIGIMAT to LS-DYNA MPP strongly coupled interface to perform nonlinear multi-scale FEA
- DIGIMAT-MF composite material models based on :
 - An elasto-viscoplastic material model for the matrix,
 - An elastic material model for the fibers as well as the fiber volume content, fiber length and fiber orientation coming from an injection code,
 - Failure indicators computed at the microscopic level.

Keywords:

Multi-scale nonlinear material modeling, micro-macro material modeling, composite materials, fiber reinforced materials, crash, failure, viscoplasticity.

1 Introduction

The accurate linear and nonlinear modeling of complex composite structures pushes the limits of finite element analysis software with respect to element formulation, solver performance and phenomenological material models. The finite element analysis of injection molded structures made of nonlinear and/or time-dependent anisotropic reinforced polymer is increasingly complex. In this case, the material behavior can significantly vary from one part to another throughout the structure and even from one integration point to the next in the plane and across the thickness of the structure due to the fiber orientation induced by the polymer flow. The accurate modeling of such structures and materials is possible with LS-DYNA using LS-DYNA's Usermat subroutine to call the DIGMAT micromechanical modeling software [1]. In addition to enabling accurate and predictive modeling of such materials and structures, this multi-scale approach provides the FEA analyst and part designer with an explicit link between the parameters describing the microstructure (e.g. fiber orientation predicted by injection molding software and the final part performance predicted by LS-DYNA).

2 Theoretical background of homogenization

In a multi-scale approach, at each macroscopic point \bar{x} (which is viewed at the microscopic level as the center of a representative volume element (RVE) of the multi-phase material under consideration), we know the macroscopic strain $\bar{\varepsilon}$ and we need to compute the macroscopic stress $\bar{\sigma}$ or vice-versa. At the microscopic level, we have an RVE of domain ω and boundary $\partial\omega$. It can be shown that if linear boundary conditions are applied on the RVE, relating macroscopic stresses and strains is equivalent to relating average stresses $\langle\sigma\rangle$ to average strains $\langle\varepsilon\rangle$ over the RVE. The homogenization procedure is divided in three steps (see Figure 1). In the first step, called the localization step, the given macroscopic strain tensor is localized in each phase of the composite material. In the second step, constitutive laws are applied for each phase and a per phase stress tensor is computed. The phases' stress tensors are averaged in the last step to give the macroscopic stress tensor. The composite behavior will depend explicitly on the phase behavior, the current inclusion shape and the current inclusion orientation.

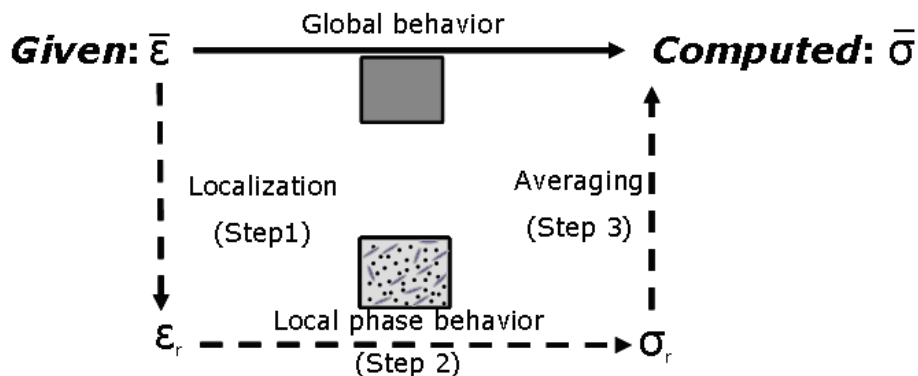

Figure 1 : Homogenization - General scheme

2.1 Homogenization of a two-phase composite

Let's consider a two-phase composite where inclusions (denoted by subscript 1) are dispersed in a matrix (subscript 0). The matrix, which extends on domain ω_0 , has a volume V_0 and volume fraction given by :

$$v_0 = \frac{V_0}{V} \quad (1)$$

where V is the volume of the RVE. The inclusion phase, which extends on domain ω_1 , has a total volume V_1 and a volume fraction given by:

$$v_1 = \frac{V_1}{V} = 1 - v_0 \quad (2)$$

We then define the following volume averages, respectively over the RVE and both phases:

$$\langle f \rangle \equiv \frac{1}{V} \int_{\omega} f(\mathbf{x}, \bar{\mathbf{x}}) dV, \quad \langle f \rangle_{\omega_r} \equiv \frac{1}{V_r} \int_{\omega_r} f(\mathbf{x}, \bar{\mathbf{x}}) dV_r, \quad r = 0,1 \quad (3)$$

where the integration is carried out with respect to the micro coordinate \mathbf{x} . In the following, dependence on macroscopic coordinates $\bar{\mathbf{x}}$ will be omitted for simplicity. It is easy to check that these averages are related by:

$$\langle f \rangle = v_1 \langle f \rangle_{\omega_1} + v_0 \langle f \rangle_{\omega_0} \quad (4)$$

The per phase strain averages are related by a strain concentration tensor B^ε as follows:

$$\langle \varepsilon \rangle_{\omega_1} = B^\varepsilon \langle \varepsilon \rangle_{\omega_0} \quad (5)$$

Various homogenization models were proposed in the literature and differ in the expression of B^ε .

The per phase strain averages are related to the macroscopic strain $\bar{\varepsilon} = \langle \varepsilon \rangle$ by:

$$\langle \varepsilon \rangle_{\omega_0} = [v_1 B^\varepsilon + (1 - v_1) I]^{-1} : \langle \varepsilon \rangle \quad (6)$$

and

$$\langle \varepsilon \rangle_{\omega_1} = B^\varepsilon : [v_1 B^\varepsilon + (1 - v_1) I]^{-1} : \langle \varepsilon \rangle \quad (7)$$

Except for the simplest models (e.g. Voigt model, which assumes uniform strains over the RVE and Reuss model, which assumes uniform stress), homogenization models are based on the fundamental solution of Eshelby [3,2]. That solution allows solving the problem of a single ellipsoidal inclusion (I) of uniform moduli c_1 which is embedded in an infinite matrix of uniform modulus c_0 . Under a remote uniform strain $\bar{\varepsilon}$, it is found that the strain field in the inclusion is uniform and related to the remote macroscopic strain by:

$$\varepsilon(\mathbf{x}) = H^\varepsilon(I, c_1, c_0) : \bar{\varepsilon} \quad \forall \mathbf{x} \in (I) \quad (8)$$

where the single strain concentration tensor H^ε has the following expression:

$$H^\varepsilon(I, c_1, c_0) = [I + P(c_0, c_1) : (c_1 - c_0)]^{-1} \quad (9)$$

and where

$$P(c_0, c_1) = \xi(I, c_0) : (c_0)^{-1} \quad (10)$$

denotes the polarization tensor which is evaluated from Eshelby's tensor $\xi(I, c_0)$, which can be computed analytically in the simplest case and numerically in more general cases. Let's also note that for any homogenization model defined by an expression of B^ε , the macroscopic stiffness \bar{c} is given by:

$$\bar{c} = [v_1 c_1 : B^\varepsilon + (1 - v_1) c_0] : [v_1 B^\varepsilon + (1 - v_1) I]^{-1} \quad (11)$$

The Mori-Tanaka model (M-T) was proposed by Mori and Tanaka [4] and is such that the strain concentration tensor B^ε is equal to $H^\varepsilon(I, c_1, c_0)$. Thus the M-T model has the following physical interpretation: each inclusion behaves like an isolated inclusion in the matrix seeing $\langle \varepsilon \rangle_{\omega_0}$ as a far strain field.

From the strain fields in the phases, the stresses can be computed using the material laws assigned to the phases. The material behavior of the phases can be nonlinear and can, amongst other, involved strain-rate or thermal dependencies. These stresses are then averaged in order to compute the macroscopic stresses which thus, if any, reflect the non-linearity and the anisotropy of the composite microstructure at micro-level, as well as the strain-rate or thermal dependencies defined for the phases.

This theory can be extended to composites containing a matrix and inclusions of different shapes, orientations or material properties. In that case, the inclusions are classified into N phases (i) of volume fraction v_i

$$v_0 + \sum_{i=1}^N v_i = 1. \quad (12)$$

2.2 Definition of failure criteria in DIGIMAT

As DIGIMAT gives access to stresses, strains, as well as material history variables at the micro level, one can define failure criteria based on these fields. In order to be complete here are the different levels at which the user can define failure criteria:

- *Macroscopic level*: Based on composite stress or strain fields.
- *Microscopic level*: Based on phases' stress, strain or history variable fields.
- *Pseudo-grain level*: Based on pseudo-grain stress, strain or history variable fields.

This last option which involved pseudo-grains allows to work at a level at which all fibers are supposed to be perfectly aligned in a given direction. This intermediate homogenization step comes from the discretization of the fiber orientation distribution function which characterizes the orientation of the fibers. This concept of pseudo grain is schematically illustrated in figure 2. This intermediate homogenization level allows defining failure criteria and their strength parameters for a generic and simple microstructure (i.e. for which the fibers are fully aligned) and within a local axis system attached to the fibers. In other words, the user can characterized the strengths of a two-phases composite (for example by giving two strengths corresponding to the fiber and cross fiber directions) and then the failure computation and homogenization over the pseudo-grains will, at the end, give access to a failure information at the macroscopic level at which the fiber orientation follows a given distribution.

This last option involving pseudo-grains also allow, within the *First Pseudo Grain Failure* (FPGF) model, to progressively reduce the composite stiffness following the evolution of the failure within the pseudo-grains. This concept is illustrated in figure 3. It basically consists in computing the failure indicators which where defined in the pseudo-grains and to reduce the stiffness contribution to the composite stiffness of the pseudo-grains that reach their failure limit. The final failure of the composite is finally reached when a critical fraction of pseudo-grains has failed.

In terms of failure indicators, DIGIMAT allows to define most well known failure indicators starting from simple maximum stress or strain criteria to more evolved criteria like Tsai-Hill, Tsai-Wu or Hashin criteria. All the strength involved in these failure criteria can either be constant or dependent over the total or plastic strain rate.

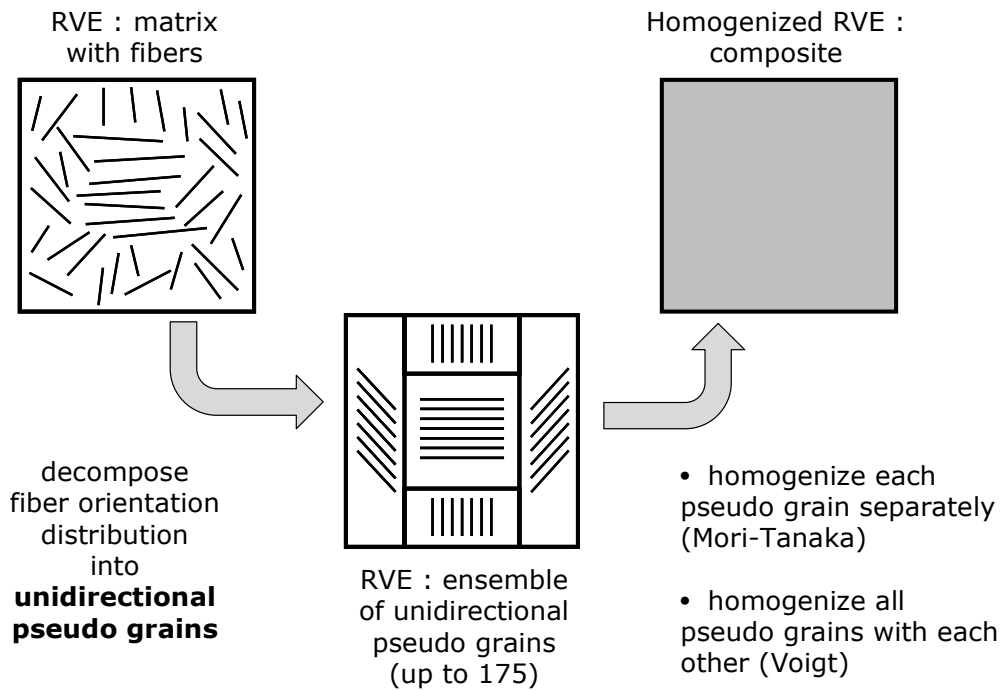

Figure 2: Schematic illustration of the discretization of the orientation distribution function and of the concept of pseudo-grain

Failure criteria computed by DIGMAT are finally used to trigger element deletion when used in a coupled DIGMAT to LS-DYNA analysis. Thus failure criteria defined within such a multi-scale FEA allows to have macroscopic failure propagations due to microscopic failure indicators.

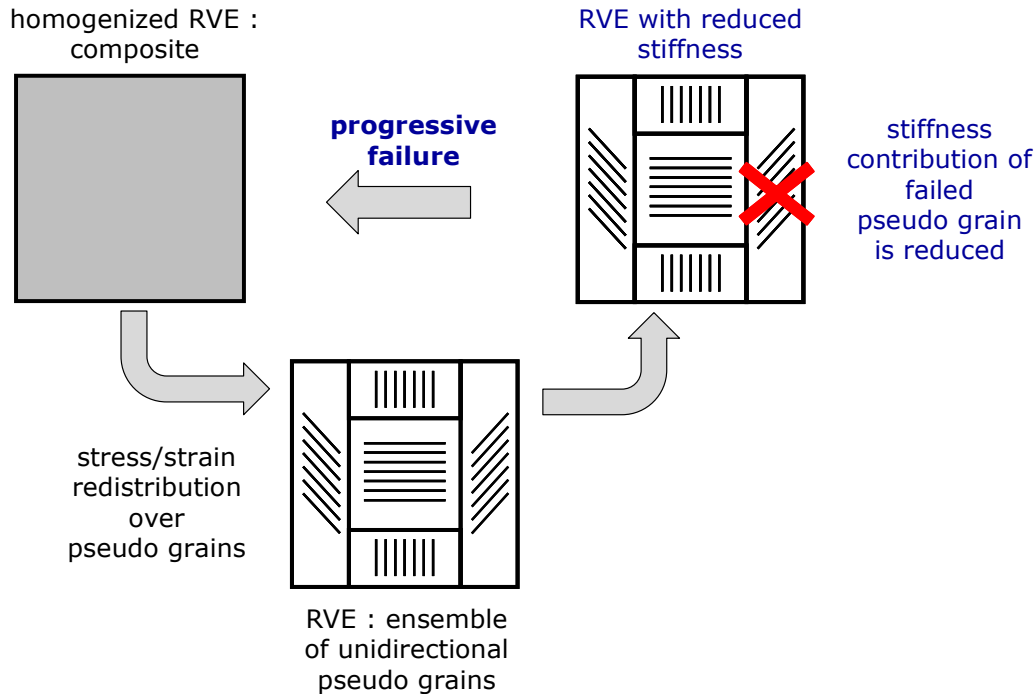

Figure 3: Composite stiffness reduction due to pseudo-grain failure (First Pseudo Grain Failure model)

3 Procedure

DIGIMAT can be linked to LS-DYNA through its user-defined material interface enabling the following two-scale approach: A classical finite element analysis is carried out at macro scale, and for each time/load interval $[t_n, t_{n+1}]$ and at each element integration point, DIGIMAT is called to perform an homogenization of the composite material under consideration (Figure 4).

Based on the macroscopic strain tensor $\bar{\varepsilon}$ given by LS-DYNA, DIGIMAT computes and returns, amongst other, the macroscopic stress tensor at the end of the time increment. The microstructure is not seen by LS-DYNA but only by DIGIMAT, which considers each integration point as the center of a representative volume element of the composite material.

The material response computed by DIGIMAT will strongly depend on the phases' behavior and the inclusion shape but also on the inclusion orientation.

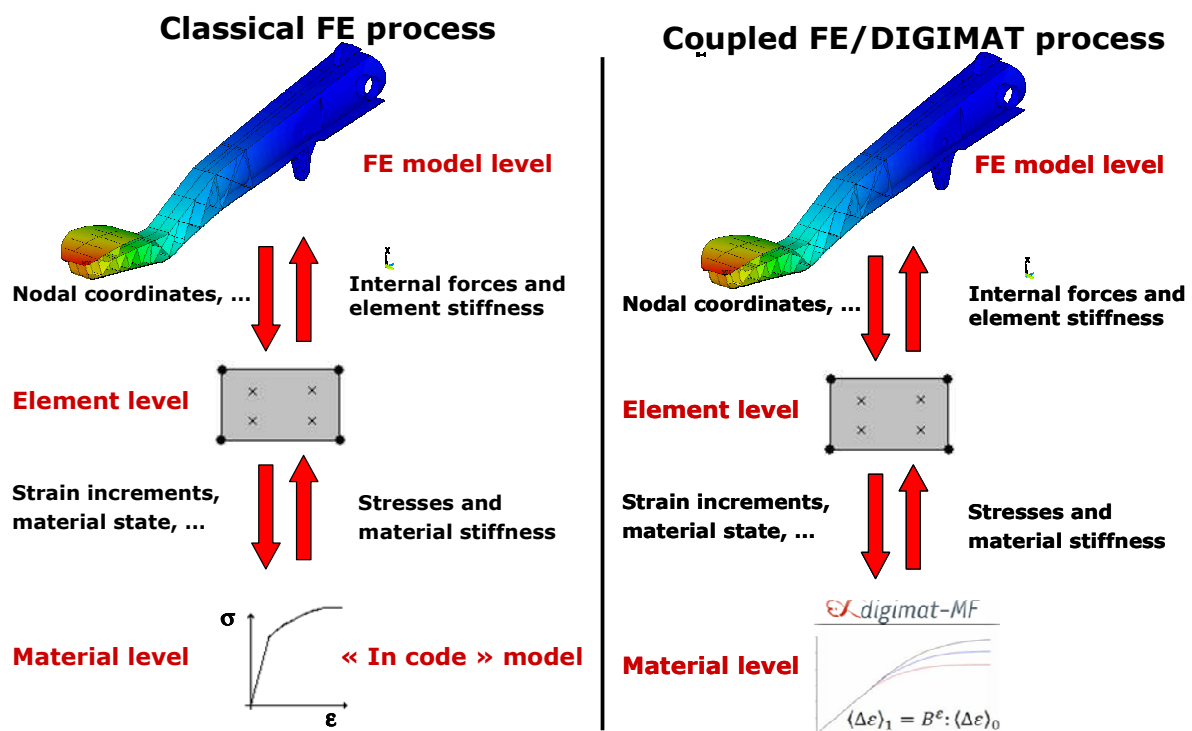

Figure 4 : Interaction between DIGIMAT and LS-DYNA. Left : Classical FE procedure – Right : Multi-scale procedure using DIGIMAT as the material modeler (FE model : courtesy of Trelleborg)

When a part is injected with a polymer reinforced by glass fibers, the fibers' orientation will differ from one point to another. The microstructure of the composite will thus be different for each integration point of the FE model. Interfaces between injection molding software (like Moldflow, Sigmasoft or Moldex3D) and DIGIMAT can also be used jointly with the DIGIMAT – LS-DYNA interface. The predicted microstructure at the end of the molding process (e.g. the orientation of the fibers) can thus be used as an input to DIGIMAT.

As the optimal injection and structural meshes are different, one needs to transfer information (e.g. fibers' orientation, temperature, initial stresses, ...) from the first to the second in order to proceed with the FEA. This mapping operation is performed by Map which is part of DIGIMAT. The complete process, involving an injection code, LS-DYNA & DIGIMAT, is schematically represented in the flow diagram in Figure 5.

Another advantage of using DIGIMAT to simulate composite materials within FE analyses is that, in addition to the macro stress, DIGIMAT will compute stresses and strains in the phases and store it in LS-DYNA history variables. As described before, this is very useful, amongst other, in order to apply failure criteria at the microscopic level instead of the macroscopic level and to post-process these fields as any other macroscopic stress or strain fields.

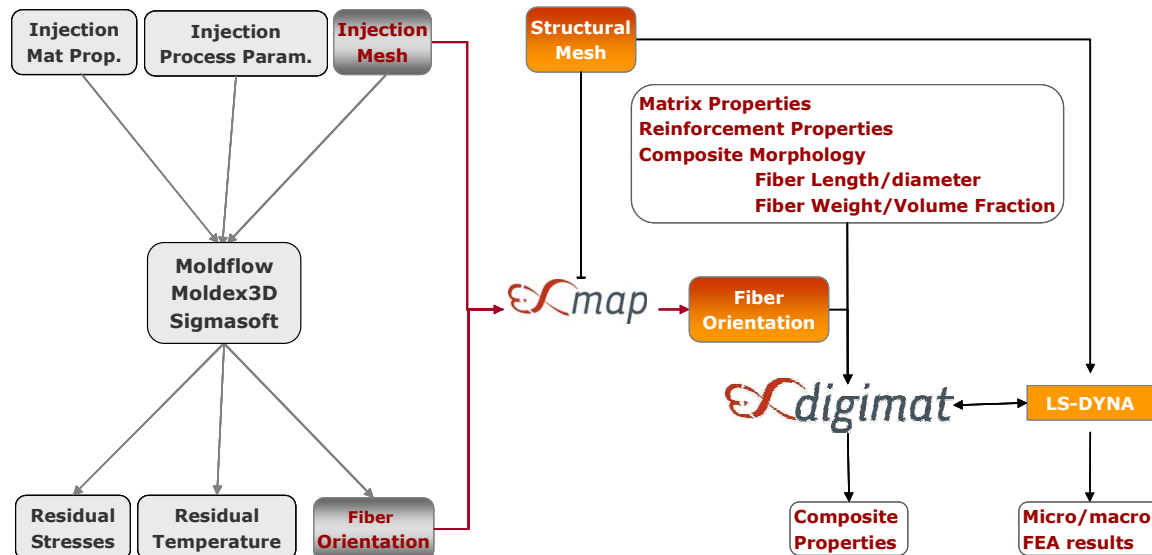

Figure 5 : Flow diagram of a typical multi-scale FEA analysis on a short fiber reinforced composite involving DIGIMAT

4 Applications

Impact tests on glass fiber reinforced polymer plates were performed using DIGIMAT coupled to LS-DYNA and can be used, for example, to analyze the sensitivity of the impact properties to the fiber's concentration, orientation and length. Figure 6 shows the initial configuration illustrating the impact tests setup. In this case the plate, which is 60x60x3 mm, is clamped on its borders and is impacted by a rigid body falling from 1m height. The plate is made of 900 elements which are composite shell elements consisting of 20 layers. The injection model of the plate gives access to fiber orientation for all the 20 layers on the injection mesh made of triangular elements. The mapping operation between the injection and structural meshes allows to set up the FEA model and to visualize the fiber orientation on the structural model (see Figure 7). The mapping operation also allows to choose the number of composite shell layers to use in the FEA model (in this case a very fine description, e.g. 20 layers, was used).

In addition to the fiber orientation coming from the injection process, the DIGIMAT composite material model involves the material properties of the matrix which, in this case, follows an elasto-viscoplastic material model, the material properties of the elastic glass fibers, the fiber mass content as well as their aspect ratio (i.e. ratio between the fiber length and diameter).

In this impact analysis, element deletion was based on failure criteria computed at the pseudo-grain level. Two strain based failure indicators were defined monitoring respectively the failure in the fiber and cross fiber direction of the pseudo-grains.

Figure 8 shows typical results coming from such analysis including the failure pattern, fraction of failed pseudo-grains and accumulated plastic strain in the polymer matrix.

This model was run on a 64 bit Linux cluster using the MPP version of the DIGIMAT to LS-DYNA interface.

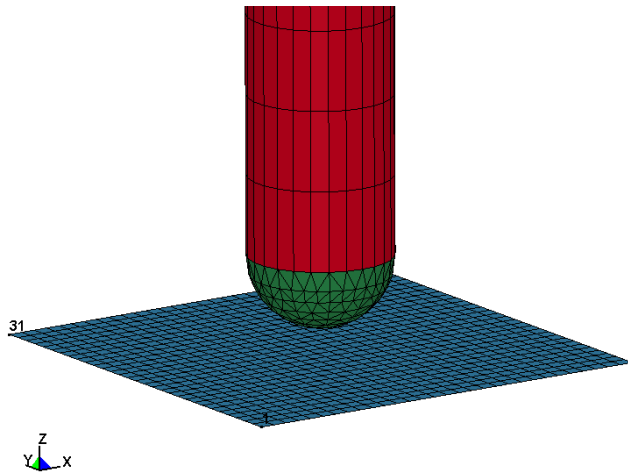

Figure 6: Impact of glass reinforced polymer plate with a falling weight (1m height drop)

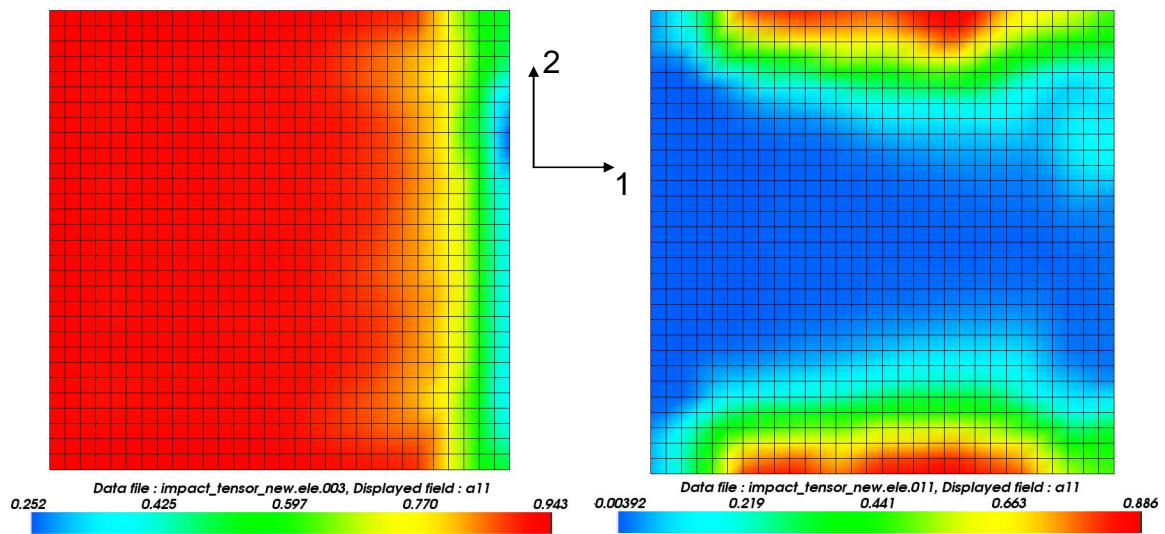

Figure 7: Fiber orientation (second order orientation tensor a_{ij}) on the structural mesh. Left: Orientation at skin (most fibers are aligned in direction 1 except at the right end). Right: Orientation at core (most fibers are aligned along direction 2 except at top & bottom ends).

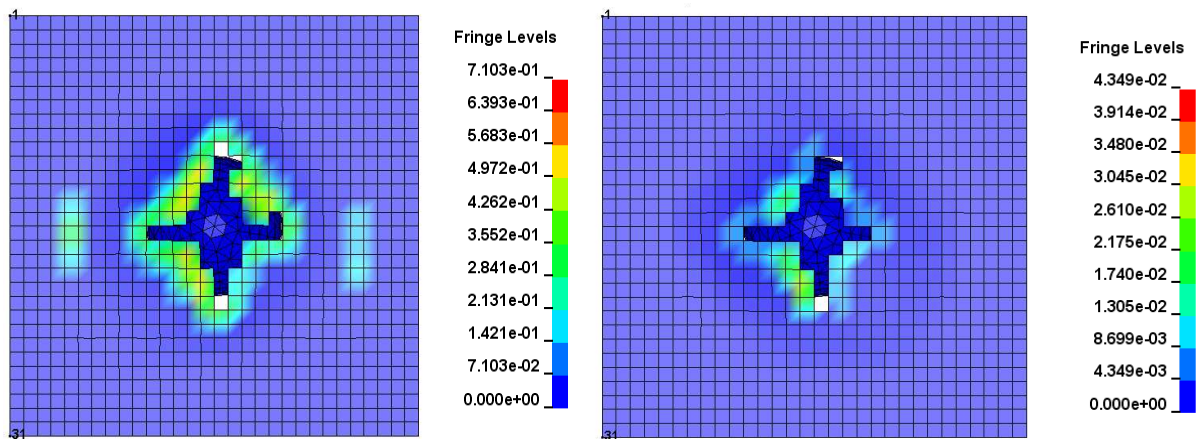

Figure 8: Left: Failure pattern and distribution of fraction of failed pseudo-grains. Right: Distribution of accumulated plastic strain in the polymer matrix

5 Summary and conclusions

Our homogenization code DIGIMAT was coupled to LS-DYNA through the user-defined material subroutine in order to perform explicit analysis. A two-scale method was used to model the behavior of nonlinear composite structures: a FE model at macro-scale, and at each integration point of the macro FE mesh, the DIGIMAT homogenization module is called. The procedure allows to compute real-world structures made of composite materials within reasonable CPU time and memory usage.

DIGIMAT thus give access to the non-linear material modeling, including failure, of composite based on multi-scale homogenization methods which allow to take into account microscopic material properties as well as the microstructure induced by the material processing.

Application to the impact of glass fiber reinforced polymers, using the predicted fiber orientation coming from the injection molding software, the nonlinear rate dependent material properties of the composite's constituents, as well as microscopically based failure indicators, was presented. The application demonstrates how it's possible to use:

- LS-DYNA MPP to solve the structural problem.
- DIGIMAT-MF as the material modeler.
- DIGIMAT to LS-DYNA MPP strongly coupled interface to perform nonlinear multi-scale FEA.
- DIGIMAT-MF composite material models based on:
 - An elasto-viscoplastic material model for the matrix,
 - An elastic material model for the fibers as well as the fiber volume content, fiber length and fiber orientation coming from an injection code,
 - Failure indicators computed at the microscopic (pseudo-grain) level.

6 Literature

- [1] DIGIMAT Software, e-Xstream engineering, Louvain-la-Neuve, Belgium.
- [2] Doghri I., "Mechanics of deformable solids. Linear, nonlinear, analytical and computational aspects". Springer, Berlin, 2000.
- [3] Eshelby J.D., "The determination of the elastic field of an ellipsoidal inclusion and related problems", Proc. Roy. Soc. London, Ser. A, 241, 1957, pp 376-396.
- [4] Mori, T. & K. Tanaka, "Average stress in matrix and average elastic energy of materials with misfitting inclusions", Acta Metall., 21, 1973, pp 571-574.



Multi-Scale Material & Structure Modeling with DIGIMAT to LS-DYNA

Thierry Malo, Thibault Villette

e-Xstream engineering S.A.

LS-Dyna User Meeting, May 14-15th, 2009

Salzburg

www.e-Xstream.com



Outline

∞ Introduction

- ✓ E-Xstream engineering
- ✓ DIGIMAT

∞ Case Study: beam impact

- ✓ Dynamic behavior of a PA-30%GF beam
 - Strain rate dependent anisotropic material
 - Failure criteria
- ✓ Mapping of fiber orientations
- ✓ Results

∞ General remarks and conclusions

- Digimat-MF: Material law modeling using a multi-layer structure
- Digimat-MF & 2CAE: Failure modeling using the FPGF mechanism
- Digimat to LS-DYAN parallelization



e-Xstream: Company Profile

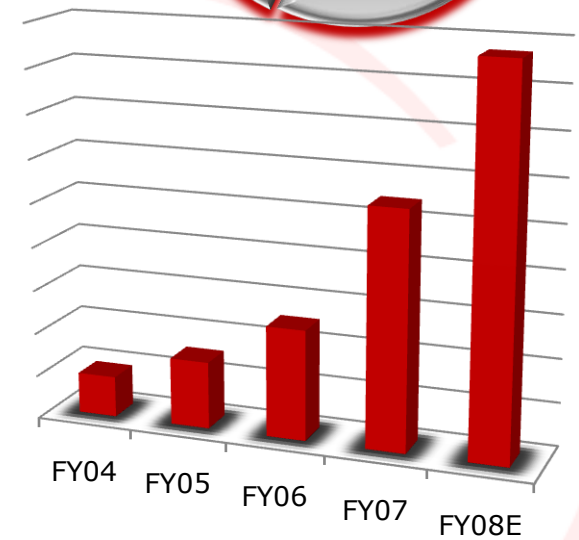
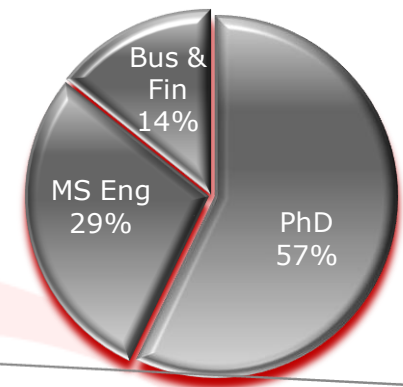

e-Xstream

- ✓ Founded in 2003
- ✓ Strong & highly motivated team
- ✓ Unique Product Line

The Business:

- ✓ Simulation Software & Services
- ✓ 100% focused on material modeling

Value Proposition

For *material suppliers & transformers* who suffer from long and costly development cycles of sub-optimal products, e-Xstream offers the *material modeling software and the expertise* needed to use in the *development of optimal materials and products faster & cheaper*.

DIGIMAT, The nonlinear multi-scale material & structure modeling platform.

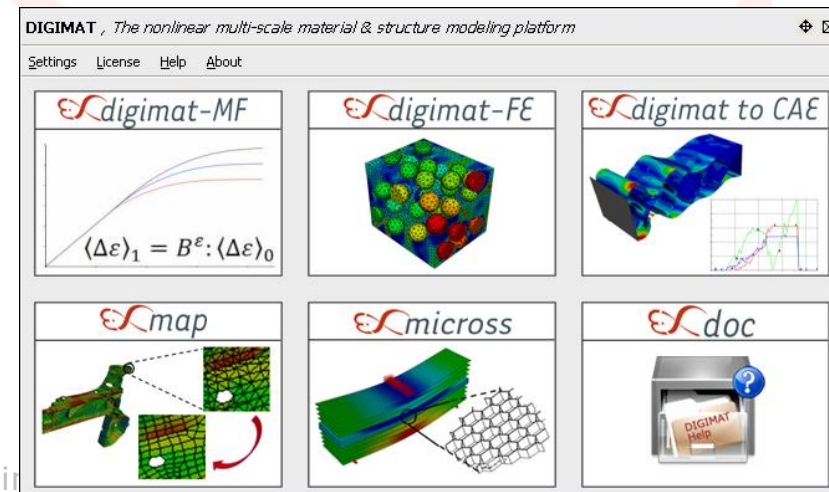



Multi-Scale Modeling: Motivation

- ∞ How can we design the optimal material ?
 - ✓ What is the relation between the material microstructure (e.g. Fiber content, length, orientation) and its final properties (e.g. Mechanical, Thermal, ...) ?

- ∞ How can we select the optimal material and optimally use its anisotropic properties in the design of composite parts ?
 - ✓ What is the link between the material and structure performance ?

- ∞ How can we optimally process the material and structure ?
 - ✓ What is the relation between the process parameters and product performance ?

- ∞ How can we achieve these objectives efficiently ?
 - ✓ Predict the composite properties (i.e. Anisotropic, nonlinear, time-dependent, ...) as a function of its microstructure.
 - ✓ Predict the product properties as a function the local material microstructure, as induced by the processing conditions (e.g. injection molding, draping,...)



DIGIMAT, *The nonlinear multi-scale material & structure modeling platform*

DIGIMAT , *The nonlinear multi-scale material & structure modeling platform*



Settings License Help About

 digimat-MF

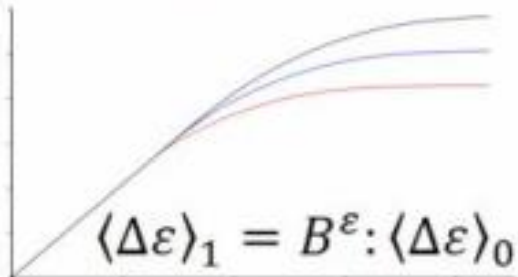

 digimat-FE

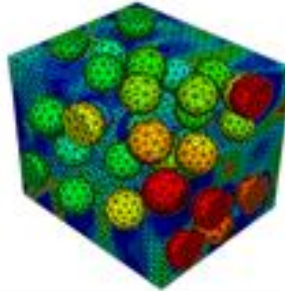

 digimat to CAE

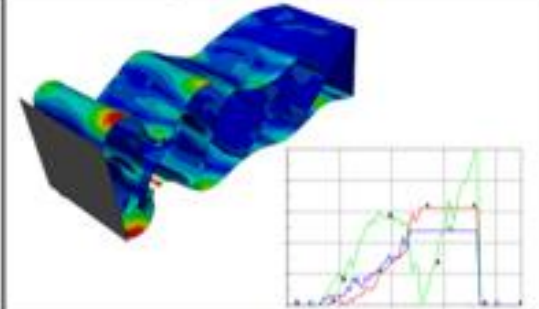

 map

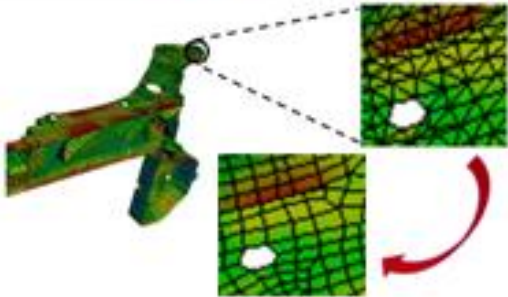

 micross

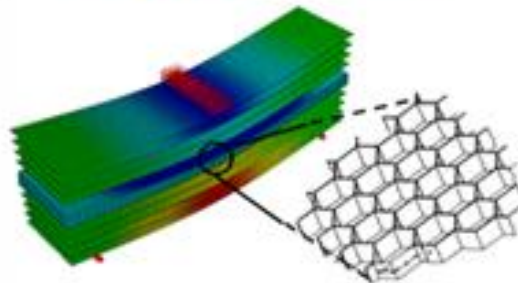

 doc





Digmat-MF: Semi-Analytical Mean Field Homogenization

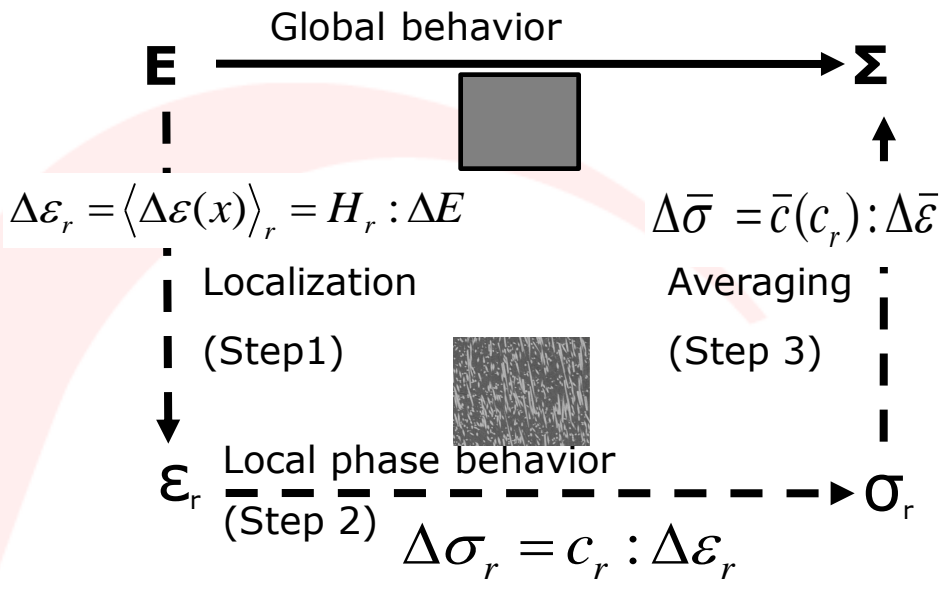
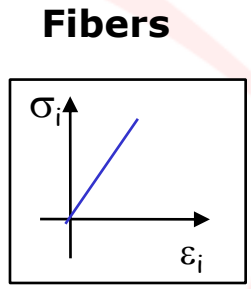
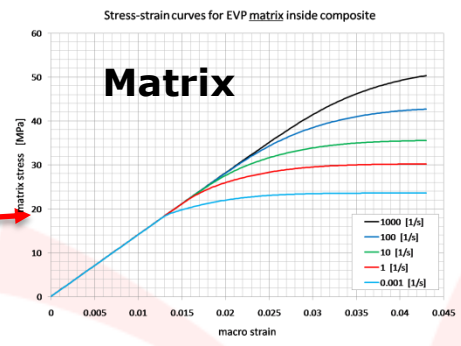
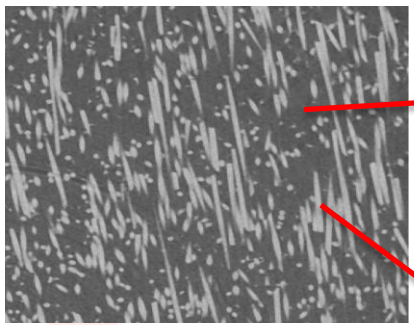

Composite behavior depends explicitly on the:

- Behavior of each phase
- Fiber shape (Aspect Ratio)
- Fiber orientation
- Fiber evolution (finite strain)

Pros

- Fast model preparation/solution
- Accurate predictions
- Enables fully coupled nonlinear multi-scale Analyses

Cons

- Ellipsoidal inclusions
- Uniformly distributed inclusions
- Average per phase (micro) results



DIGIMAT-MF: Major Capabilities

Materials: Per Phase (of a composite):

- ✓ Thermo-Elastic: Anisotropic, Temperature dependent.
- ✓ Elasto-Plastic: Small deformations/Large rotations
 - Pressure dependent (Drucker-Prager)
 - Continuous Damage (4 parameters model)
- ✓ Visco-elastic: Linear, small deformations/Large rotations
- ✓ HyperElastic-Viscoplastic: Large deformations.
- ✓ Hyperelastic (5 models): Large deformations

Micro-structure:

- ✓ N-Phase (e.g. fillers+ fibers)
- ✓ General Orientation (e.g. Orientation Tensor)
- ✓ Inclusion Coating (i.e. Fiber/Matrix Interface)
- ✓ Voids

Loading:

- ✓ Thermo-Mechanical
- ✓ Thermal
- ✓ Electric.
- ✓ Quasi-Static, Dynamic (Impact)

Micro & Macro Failure Indicators

1st & 2nd Order Incremental Homogenization Methods:

- ✓ Mori-Tanaka
- ✓ Interpolative Double Inclusion (High Concentrations/Contrast)

Nonlinear, strongly coupled to CAE Interfaces

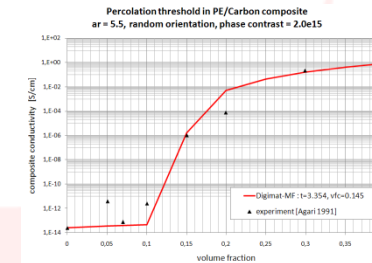
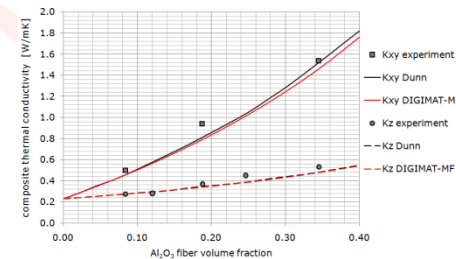
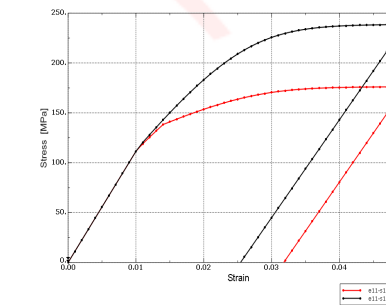
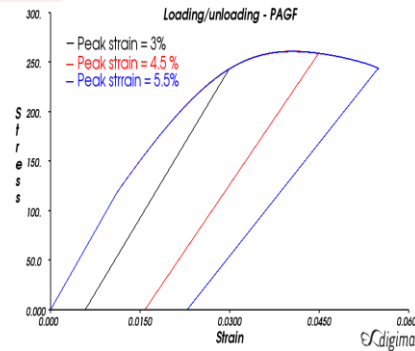
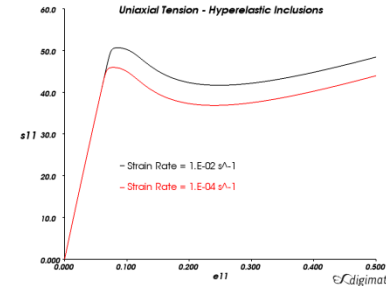
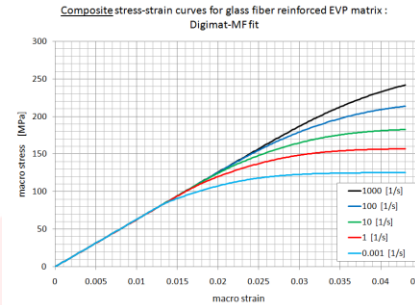



Digmat to CAE:

Interaction between DIGIMAT and FEA

Classical FE process

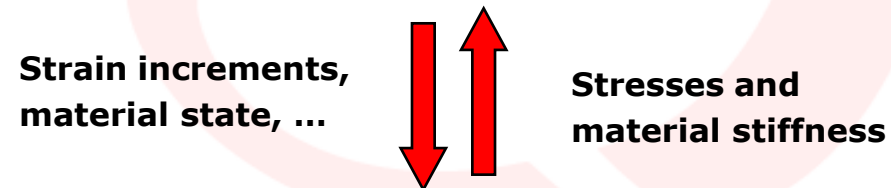
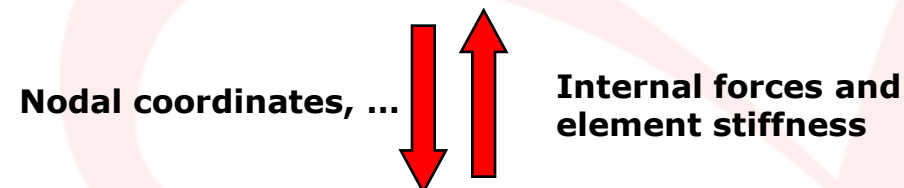
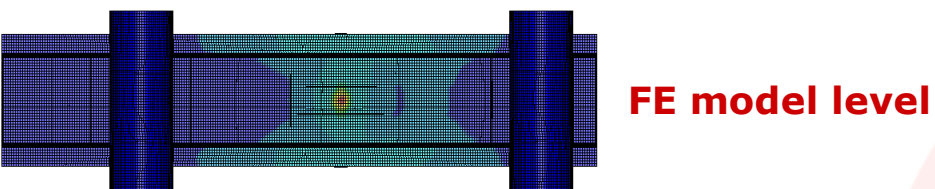

« In code » model

Coupled FE/DIGIMAT process

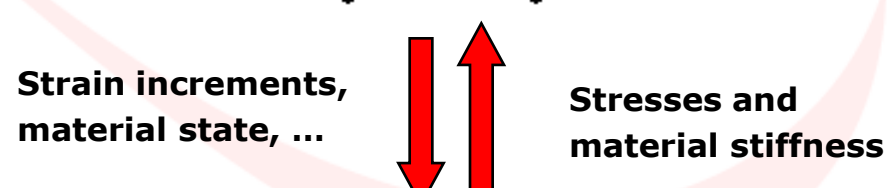
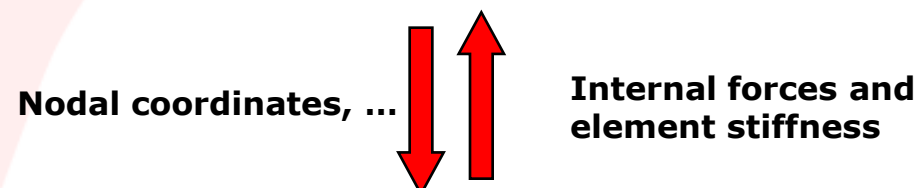
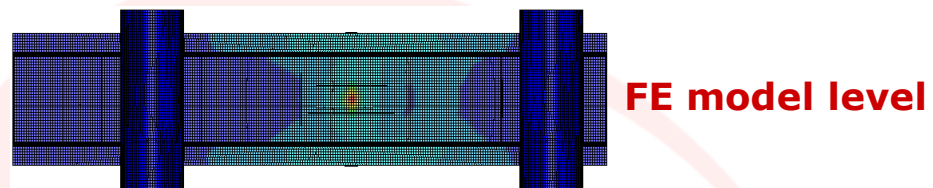

Material level

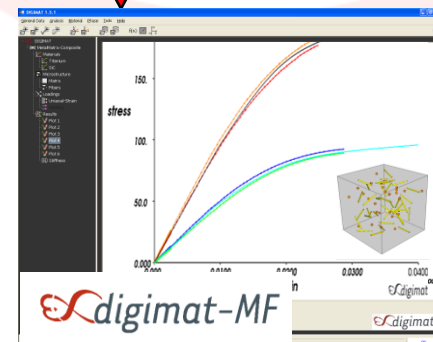



The Multi-Scale Modeling Approach for Fiber Reinforced Engineering Thermoplastic

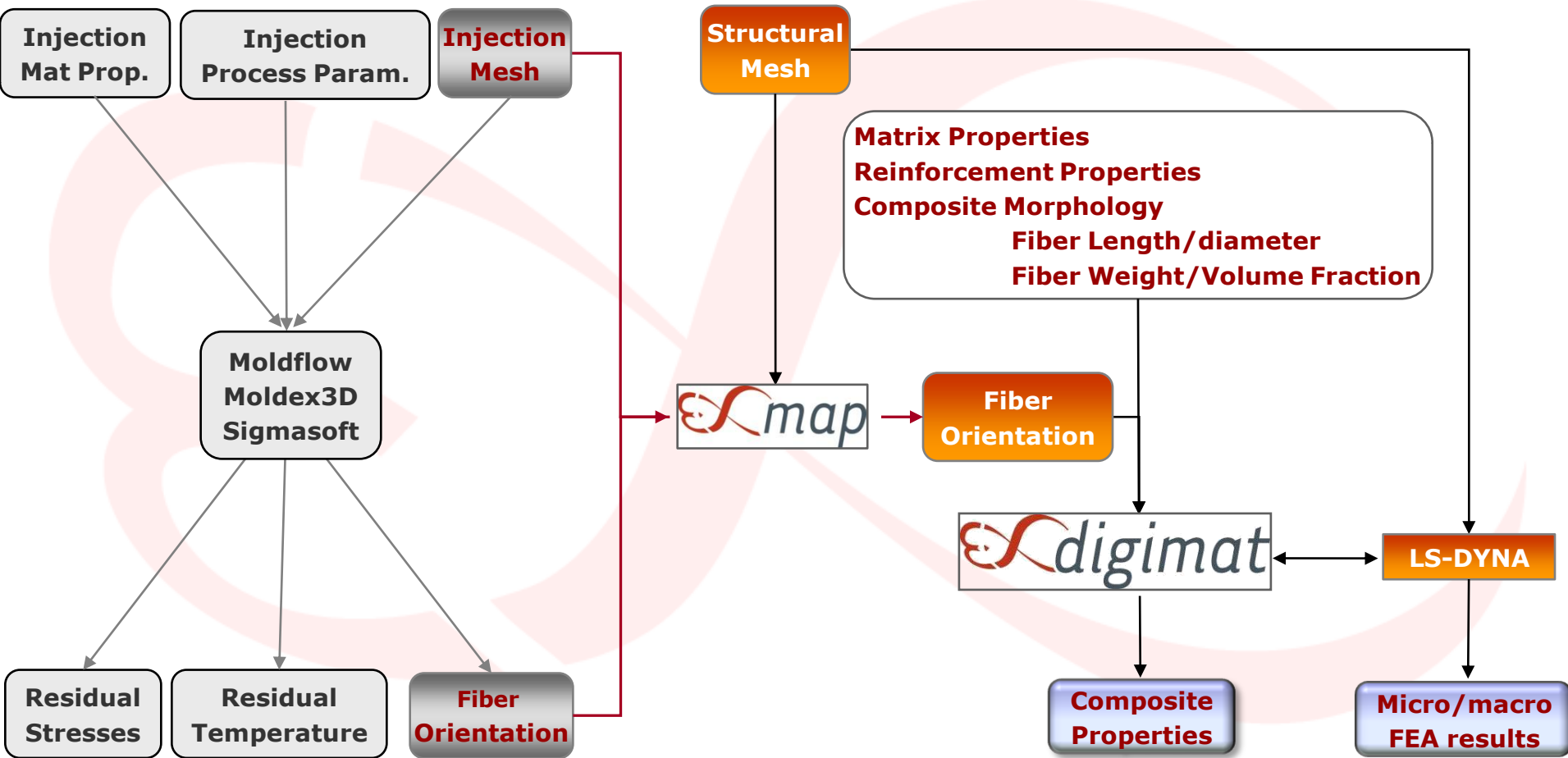

**Case Study :
Beam Impact Analysis
using LS-DYNA**

Courtesy of: **Rhodia**



Case study : reinforced thermoplastic beam

Objective

- ❑ Predict the impact behavior of a beam, made of Technyl A218 V30 21N (30% glass fiber filled Polyamide)

Analysis procedure

- ❑ MOLDFLOW injection molding simulation of the beam
 - Export fiber orientation tensors
- ❑ DIGIMAT micromechanical modeling of Technyl A218 V30 21N
 - Model the composite with reverse engineering on composite test data and use multi-layer modeling new DIGIMAT capabilities
- ❑ LS-DYNA multi-scale analysis of the beam
 - Impact loading: 5 m/s impact until failure
 - Use DIGIMAT as a micromechanical model to take account of fiber orientations predicted by Moldflow.



LS-Dyna Analysis

Boundary Conditions:

$$\begin{aligned} U_x &= U_y = 0 \\ UR_1 &= UR_2 = UR_3 = 0 \\ V_z &= -5 \text{ m/s} \end{aligned}$$

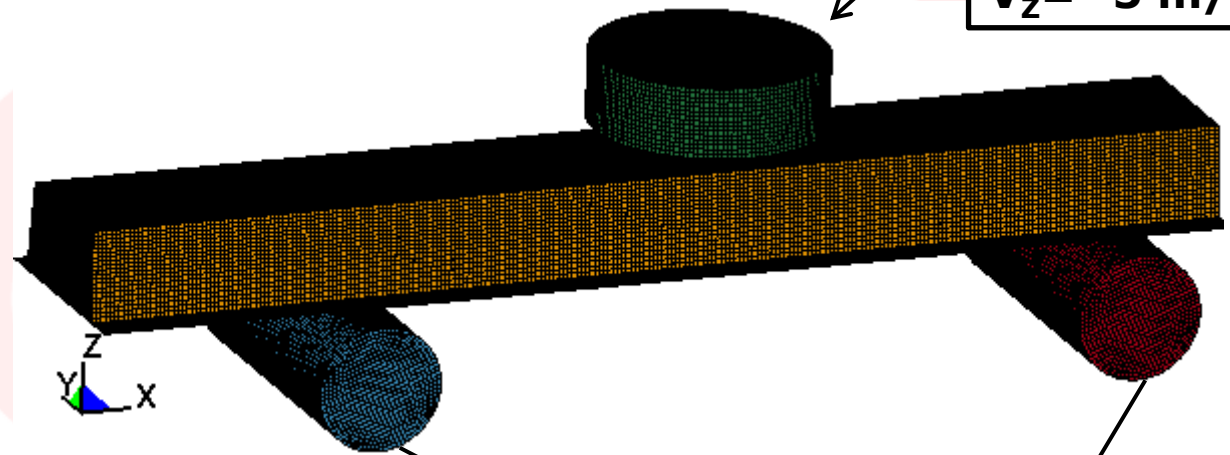

$$\begin{aligned} U_1 &= U_2 = U_3 = 0 \\ UR_1 &= UR_2 = UR_3 = 0 \end{aligned}$$

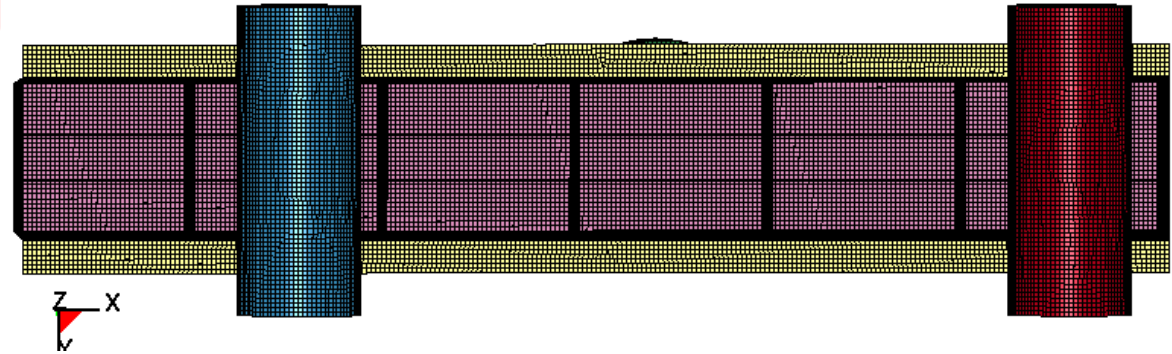
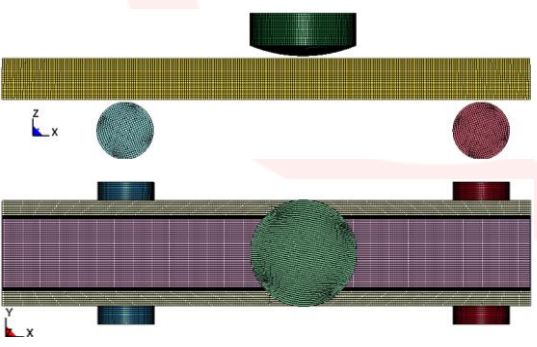

Courtesy of Rhodia



Injection molding analysis



∞ Longitudinal injection – along the beam axis

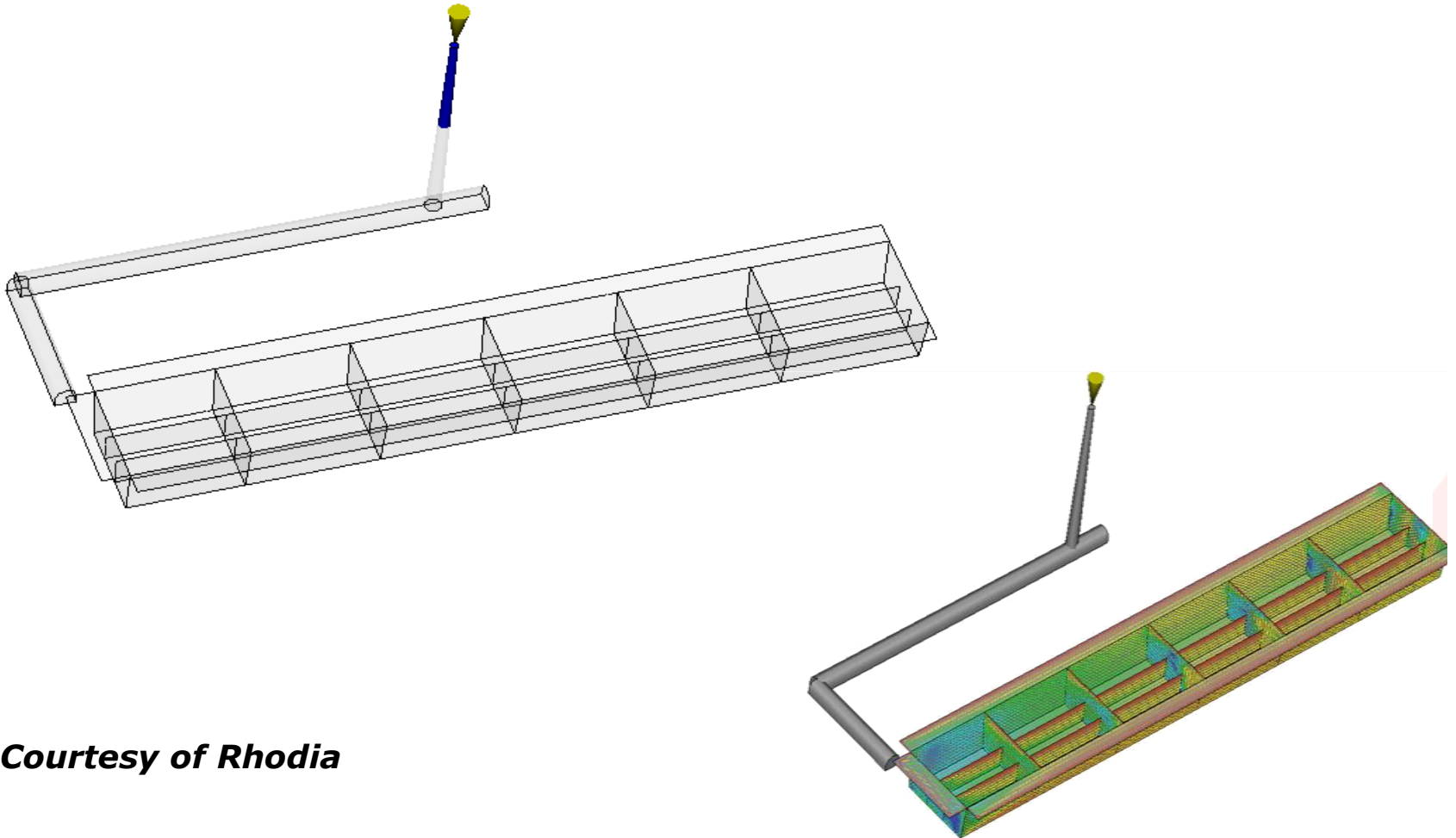

Courtesy of Rhodia



Moldflow & LS-Dyna Meshes

∞ Injection Mesh:

- ✓ Number of nodes: 3,265
- ✓ Number of elements: 6,438
- ✓ Element type: Linear tri

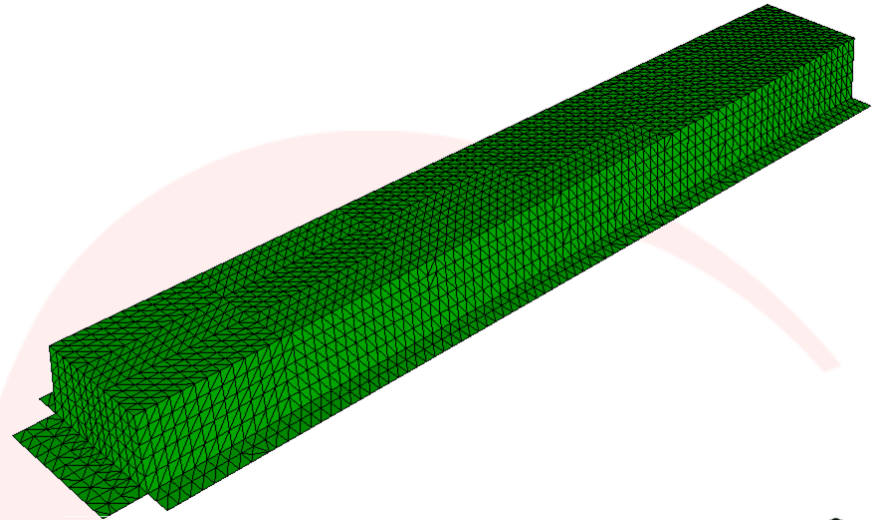

∞ Structural Mesh:

- ✓ Number of nodes: 53,395
- ✓ Number of elements: 53,354
 - ✓ Deformable elements: 32,139
 - ✓ Rigid elements: 21,215
- ✓ Element type: Belytschko-Tsay

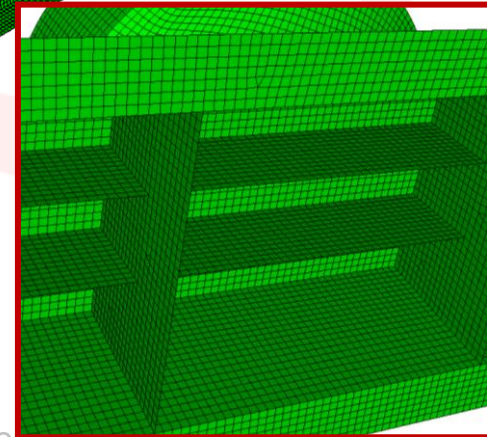
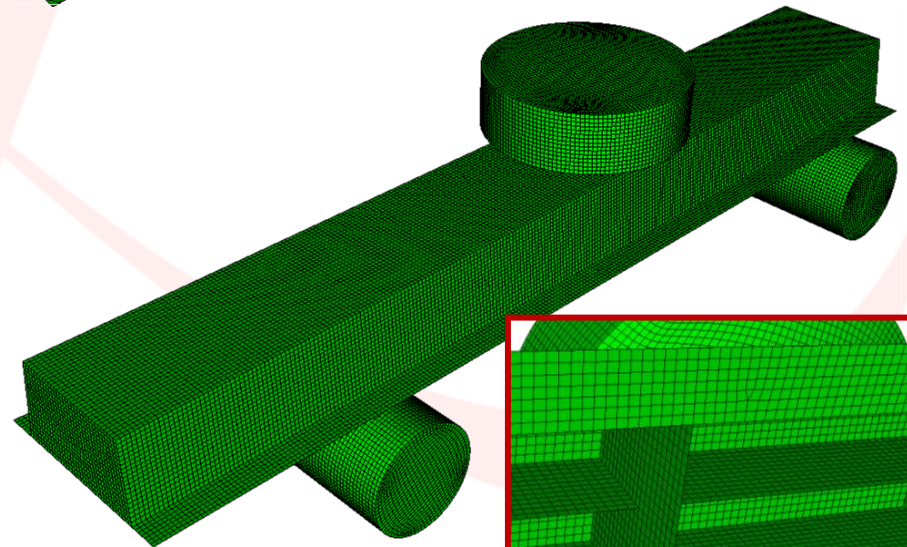

Courtesy of Rhodia



The Multi-Scale Modeling Approach for Fiber Reinforced Engineering Thermoplastic

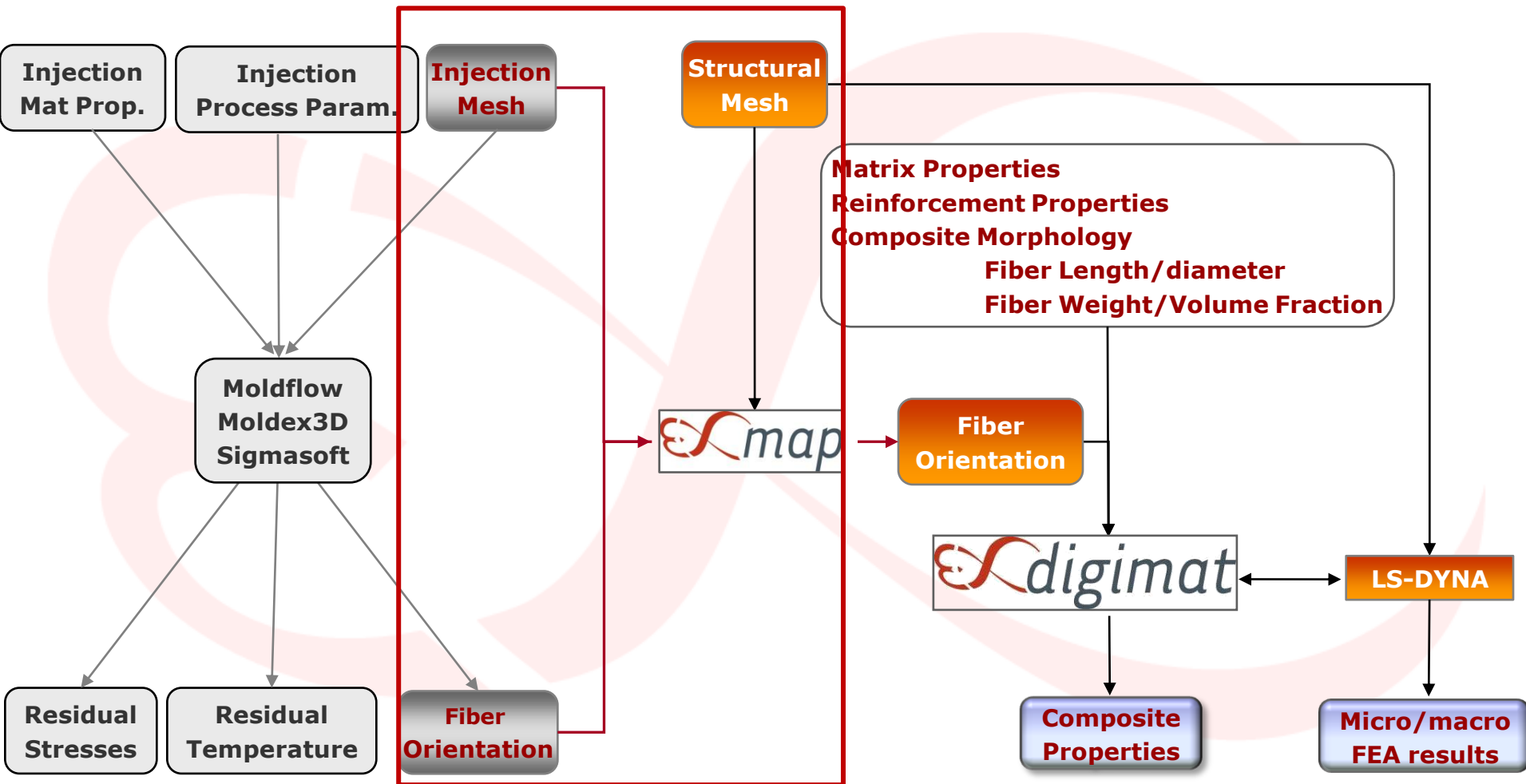



MAP: Mapping of fiber orientations

Moldflow → MAP → (Digimat to) LS-DYNA

- ∞ Mapping 2D: Orientation files provided by Moldflow (on injection mesh) are transferred from the injection mesh to the structural mesh
- ∞ Mapping 1D: Mapping from 20 to 10 layers (decreases the amount of data)

Injection mesh

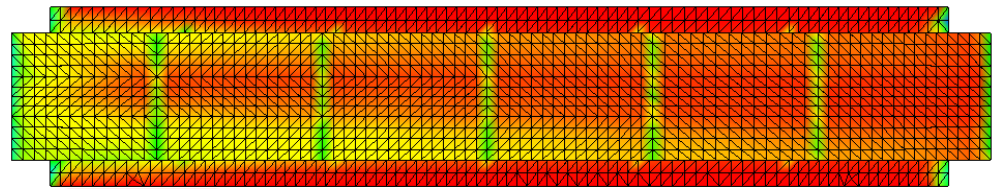

Structural mesh

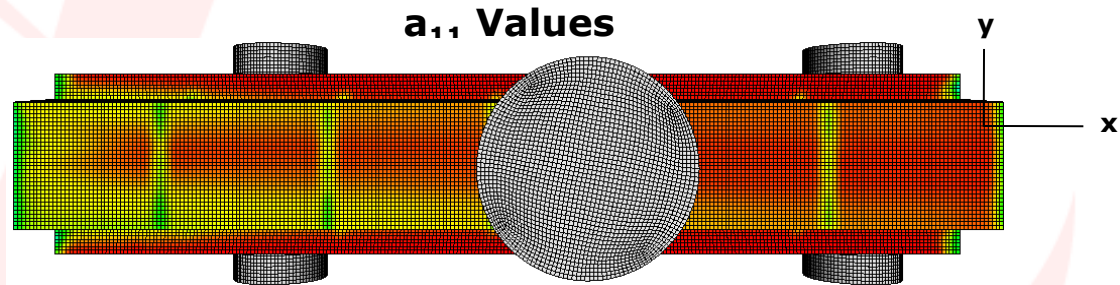

- ∞ Mapping error estimator

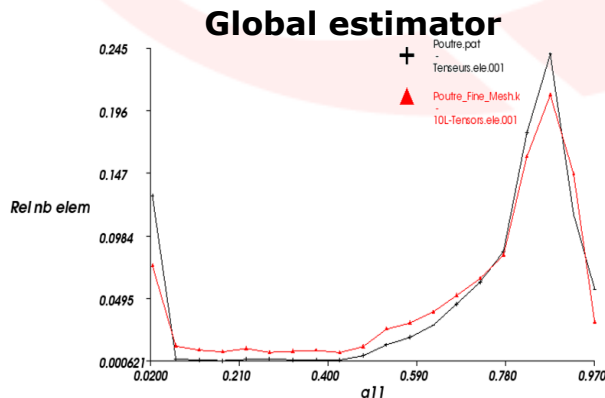

Local estimator

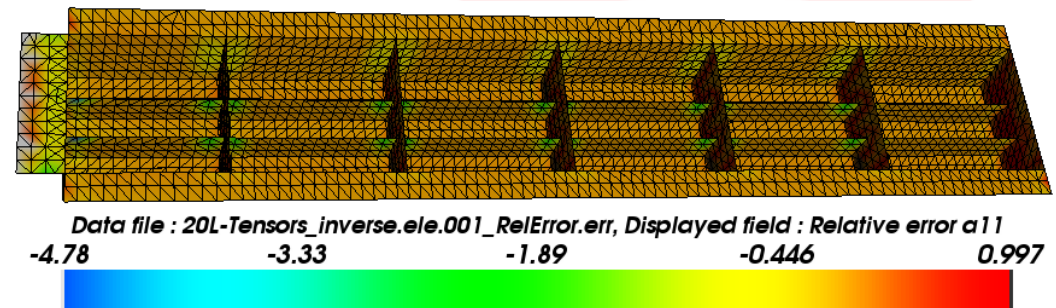



LS-DYNA FEA of the Reinforced Plastic Parts

- ∞ Geometric nonlinearities
- ∞ Contact
- ∞ Implicit/Explicit integration
- ∞ Optimal mesh refinement
- ∞ Optimal element choice
 - ✓ 1st/2nd order
 - ✓ Tet or Hex, Triangle or Quad

∞ **Material → Reinforced Plastic**

- ✓ Anisotropic
- ✓ Heterogeneous
- ✓ Nonlinear
- ✓ Rate-dependent
- ✓ Damage
- ✓ Fatigue
- ✓ Failure
- ✓ Etc.

→ Which Material Model ?



Influence of fiber orientation on material behavior

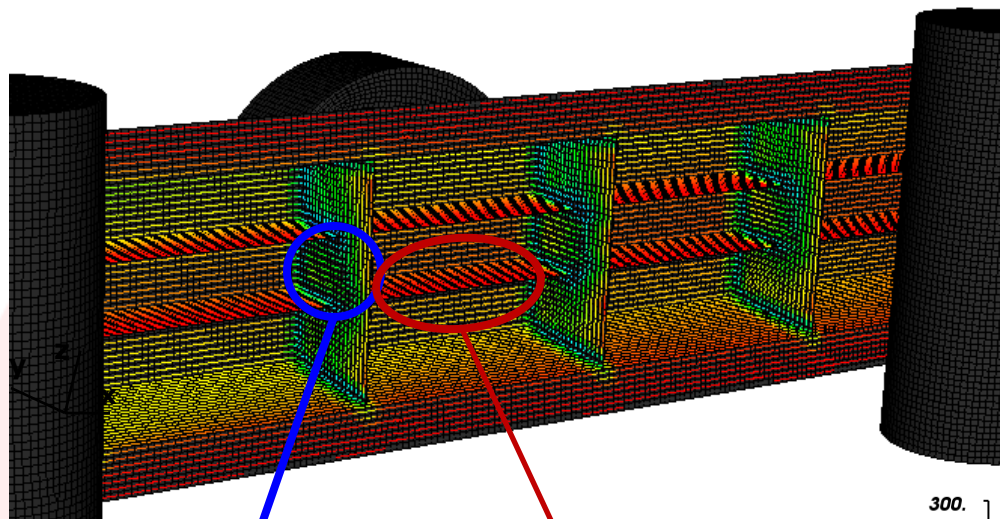

Courtesy of Rhodia

1- Random 2D

$$\begin{bmatrix} \mathbf{0.50} & 0.05 & -0.01 \\ & \mathbf{0.48} & -0.01 \\ \text{SYM} & & 0.02 \end{bmatrix}$$

2- Aligned

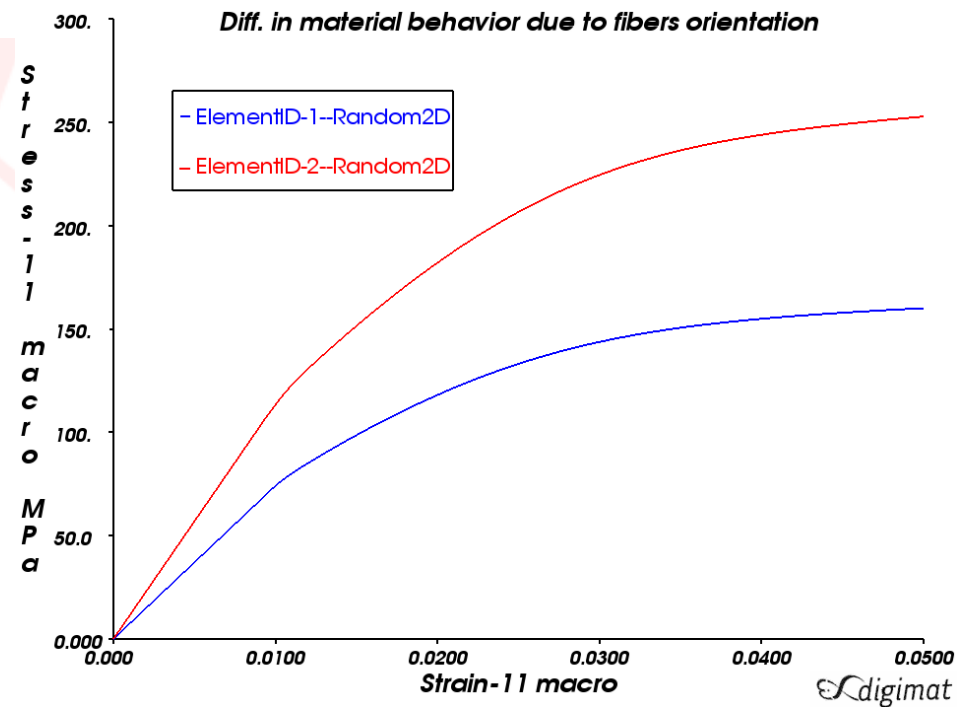
$$\begin{bmatrix} \mathbf{0.92} & 0.04 & -0.01 \\ & 0.07 & 0 \\ \text{SYM} & & 0.01 \end{bmatrix}$$



The Multi-Scale Modeling Approach for Fiber Reinforced Engineering Thermoplastic

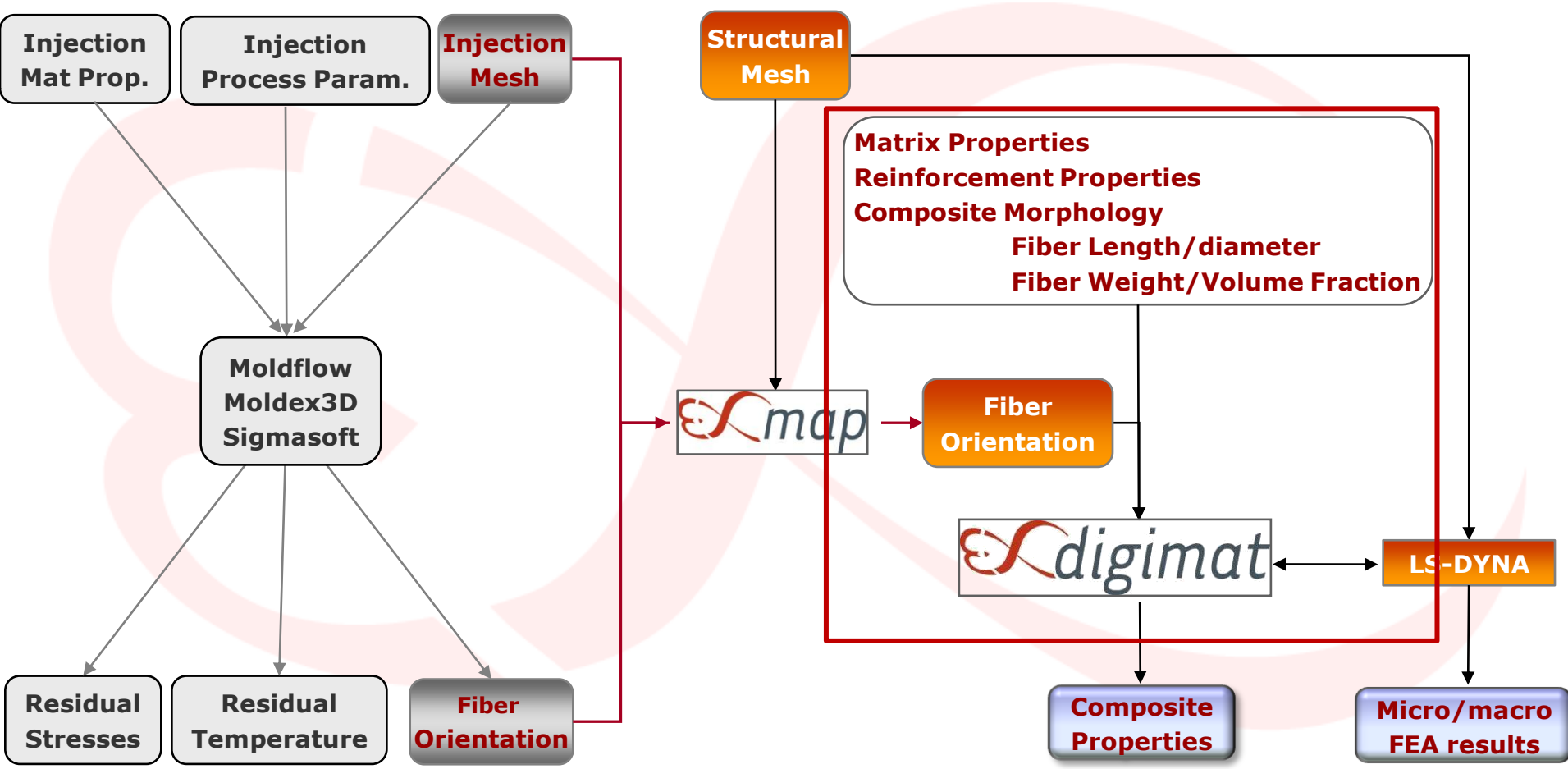



Digimat-MF : Building the material law

Modeling of multi-layer structures

- ✓ More accurate than 1 average orientation
- ✓ Skin/core effects across the thickness
- ✓ More confident reverse-engineering of the composite material

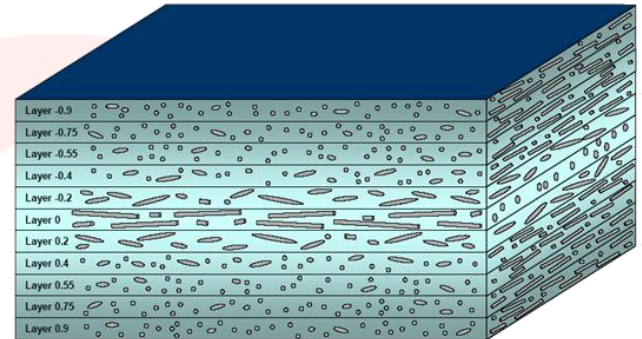

Through thickness microstructure

Courtesy of Rhodia

Multi layer definition							
	Layer name	Microstructure	Thickness	Rotation	Orientation definition	Orientation	
1	✓	Layer1	Microstructure1	0.1	0	Tensor	0.875; 0.123; 0.002; 0.013; -0.00503; 0.004
2	✓	Layer2	Microstructure1	0.1	0	Tensor	0.875; 0.123; 0.002; 0.013; -0.00503; 0.004
3	✓	Layer3	Microstructure1	0.1	0	Tensor	0.875; 0.123; 0.002; 0.013; -0.00503; 0.004
4	✓	Layer4	Microstructure1	0.1	0	Tensor	0.875; 0.123; 0.002; 0.013; -0.00503; 0.004
5	✓	Layer5	Microstructure1	0.1	0	Tensor	0.875; 0.123; 0.002; 0.013; -0.00503; 0.004
6	✓	Layer6	Microstructure1	0.1	0	Tensor	0.875; 0.123; 0.002; 0.013; -0.00503; 0.004
7	✓	Layer7	Microstructure1	0.1	0	Tensor	0.875; 0.123; 0.002; 0.013; -0.00503; 0.004
8	✓	Layer8	Microstructure1	0.1	0	Tensor	0.875; 0.123; 0.002; 0.013; -0.00503; 0.004
9	✓	Layer9	Microstructure1	0.1	0	Tensor	0.875; 0.123; 0.002; 0.013; -0.00503; 0.004
10	✓	Layer10	Microstructure1	0.1	0	Tensor	0.875; 0.123; 0.002; 0.013; -0.00503; 0.004
11	✓	Layer11	Microstructure1	0.1	0	Tensor	0.875; 0.123; 0.002; 0.013; -0.00503; 0.004
12	✓	Layer12	Microstructure1	0.1	0	Tensor	0.875; 0.123; 0.002; 0.013; -0.00503; 0.004
13	✓	Layer13	Microstructure1	0.1	0	Tensor	0.875; 0.123; 0.002; 0.013; -0.00503; 0.004
14	✓	Layer14	Microstructure1	0.1	0	Tensor	0.875; 0.123; 0.002; 0.013; -0.00503; 0.004
15	✓	Layer15	Microstructure1	0.1	0	Tensor	0.875; 0.123; 0.002; 0.013; -0.00503; 0.004
16	✓	Layer16	Microstructure1	0.1	0	Tensor	0.875; 0.123; 0.002; 0.013; -0.00503; 0.004
17	✓	Layer17	Microstructure1	0.1	0	Tensor	0.875; 0.123; 0.002; 0.013; -0.00503; 0.004
18	✓	Layer18	Microstructure1	0.1	0	Tensor	0.875; 0.123; 0.002; 0.013; -0.00503; 0.004
19	✓	Layer19	Microstructure1	0.1	0	Tensor	0.875; 0.123; 0.002; 0.013; -0.00503; 0.004
20	✓	Layer20	Microstructure1	0.1	0	Tensor	0.875; 0.123; 0.002; 0.013; -0.00503; 0.004

Reverse engineering done using 2 dumbbells:

- ✓ 1 aligned with the flow direction
- ✓ 1 transverse to the flow direction

Flow direction →

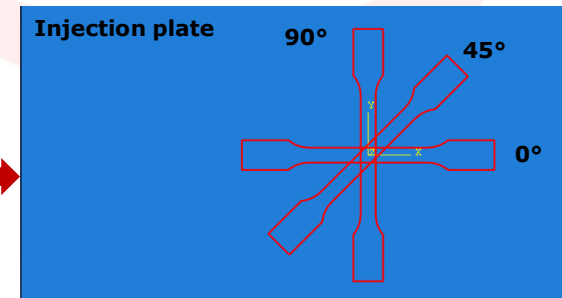



Digimat-MF : Building the material law

2 phases for PA-GF composite

- ✓ Fibres: Elastic model
- ✓ PA Matrix: Elasto-viscoplastic model
 - Hardening model: Exponential + Linear
 - Creep model: Prandtl

$$R(p) = kp + R_{\infty}[1 - \exp(-mp)]$$

$$\dot{p} = 0 \text{ if } f \leq 0, \dot{p} = \frac{\sigma_y}{\eta} \left[\sinh\left(\frac{f}{\beta}\right) \right]^m \text{ if } f > 0$$

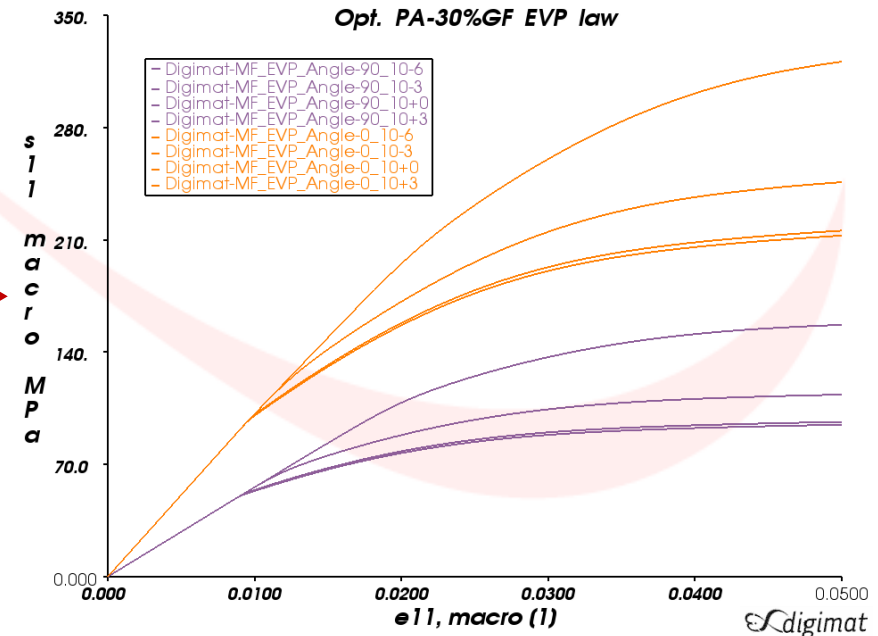
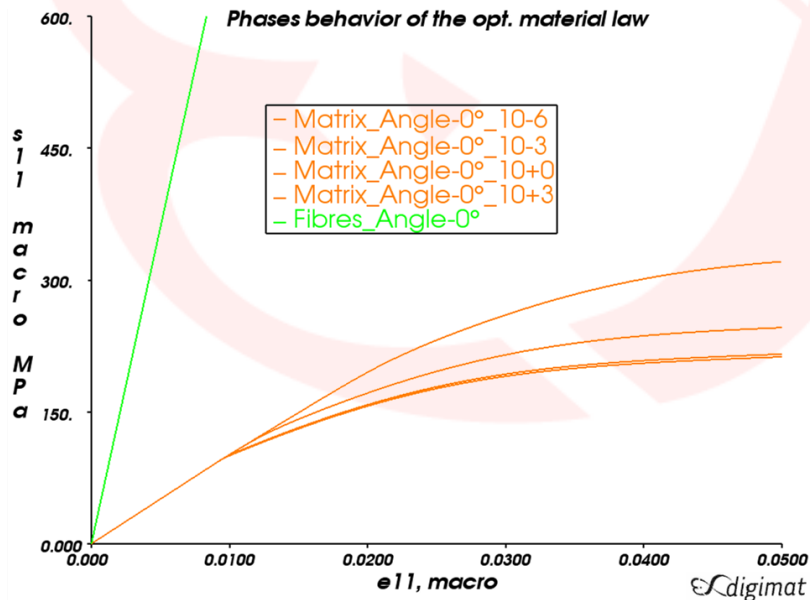



Digimat-MF: Setting failure criteria

FPGF - First Pseudo Grain Failure model

Objectives :

- ✓ Compute failure indicators at pseudo-grains (i.e. at a level for which inclusions are assumed fully aligned)
- ✓ Decrease composite stiffness following the number of failed pseudo-grains

Illustration :

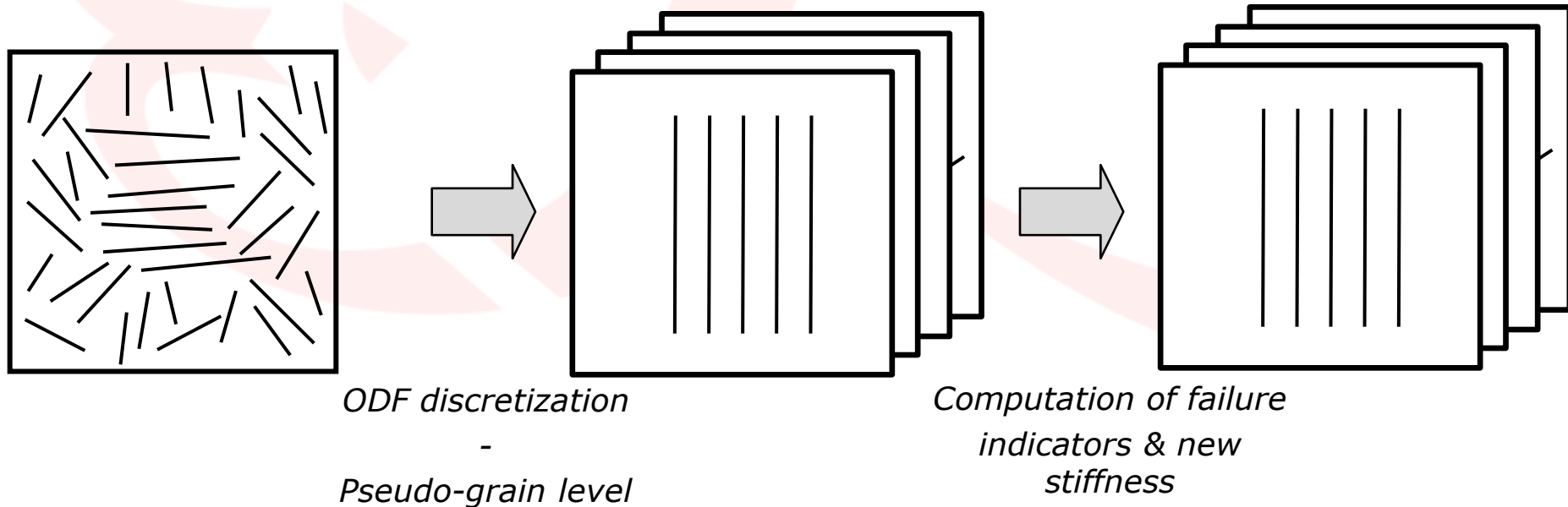



Digimat-MF: Setting failure criteria

FPGF - First Pseudo Grain Failure model

- ∞ Use any failure indicators :
 - ✓ Maximum stress/strain
 - ✓ Tsai-Hill 2D/3D
 - ✓ Tsai-Wu 2D/3D
 - ✓ ...
- ∞ Identify strengths of the composite on the most aligned and transverse cases (11 & 22)
- ∞ Affect the elasto-viscoplastic tangent stiffness following pseudo-grains failure
 - Stiffness reduction factor of a failed pseudo grain
 - Critical fraction of failed pseudo grain (for element deletion)

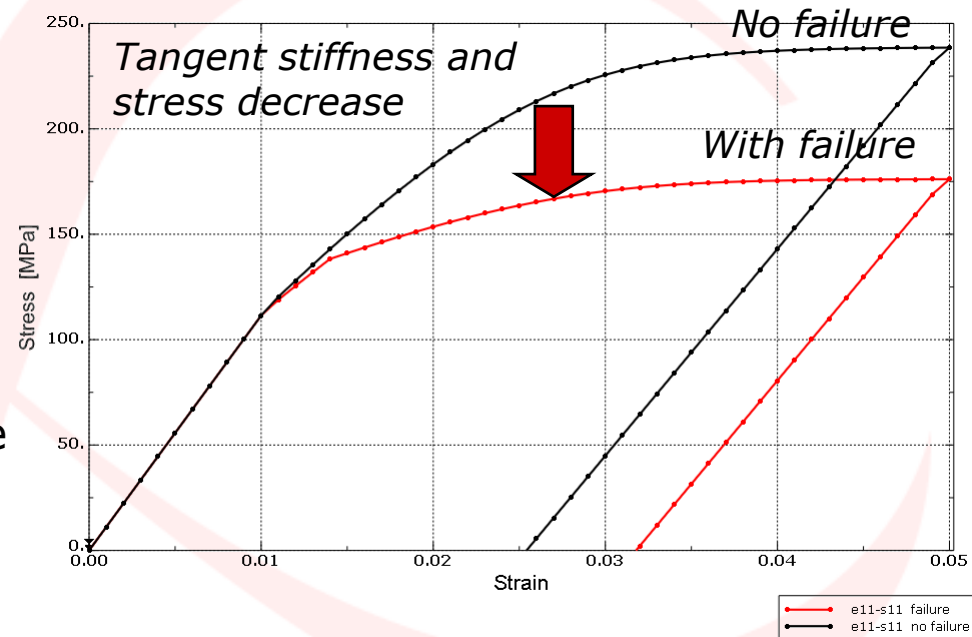

- 1 case with a set of FPGF criteria:
- Strain 11 – macro (0.0275)
 - Strain 22 – macro (0.05)



Digmat to CAE: Setting failure criteria

Strain rate dependent failure criteria

Key objectives :

- ✓ Model the strain dependence of strengths when computing failure indicators

Main characteristics :

- ✓ For a given failure indicator, the strength will depend over strain rate following two models :

- Cowper-Symonds :

$$X_T(\dot{\epsilon}) = X_T(0) \left[1 + \left(\frac{\dot{\epsilon}}{\dot{\epsilon}_0} \right)^{1/q} \right]$$

- Logarithmic Cowper-Symonds :

$$X_T(\dot{\epsilon}) = X_T(0) \left[1 + \left[\log \left(\frac{\dot{\epsilon}}{\dot{\epsilon}_0} \right) \right]^{1/q} \right]$$

- Piece-wise linear :

$$X_T(\dot{\epsilon}) = X_T(0) f_{tabular}(\dot{\epsilon})$$

1 case with a set of FPGF criteria being strain-rate dependent:

- Strain 11 – macro – SRD
- Strain 22 – macro – SRD



Exp results vs analysis: Reaction Force - Time

Experimental results (8 tests)

- ✓ Stable measurements up to 1.8ms (till 3rd force peak)
- ✓ Then great variations are observed

Digimat to LSDYNA results:

- ✓ Very good prediction of the first 2 peaks
- ✓ Good on the 3rd with the FPGF case

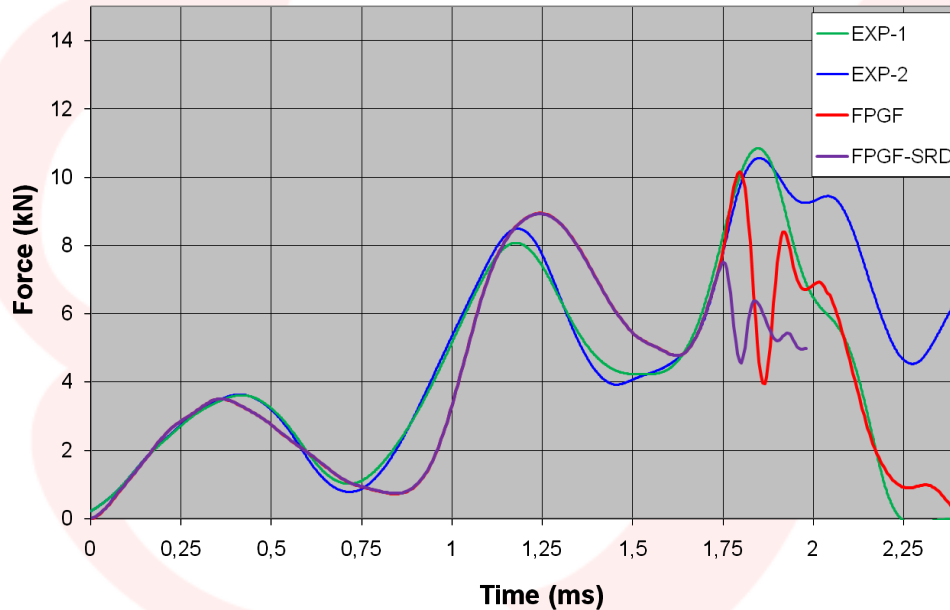

		Force (kN) - Peak 1	Force (kN) - Peak 2	Force (kN) - Peak 3
Exp	Min	3,55	7,68	10,55
	Max	3,63	8,49	11,90
	Ave	3,60	8,1	11,2
	Std. Dev.	0,03	0,3	0,5
Digimat to LS-DYNA with FPGF		3,5	8,94	10,2
error		2,80%	-10,96%	9,32%
Digimat to LS-DYNA with FPGF-SRD		3,5	8,94	7,5
error		2,80%	-10,96%	32,82%



FPGF-case results: Failure pattern

[∞ General view of the beam failure](#)

[∞ View on the pattern](#)

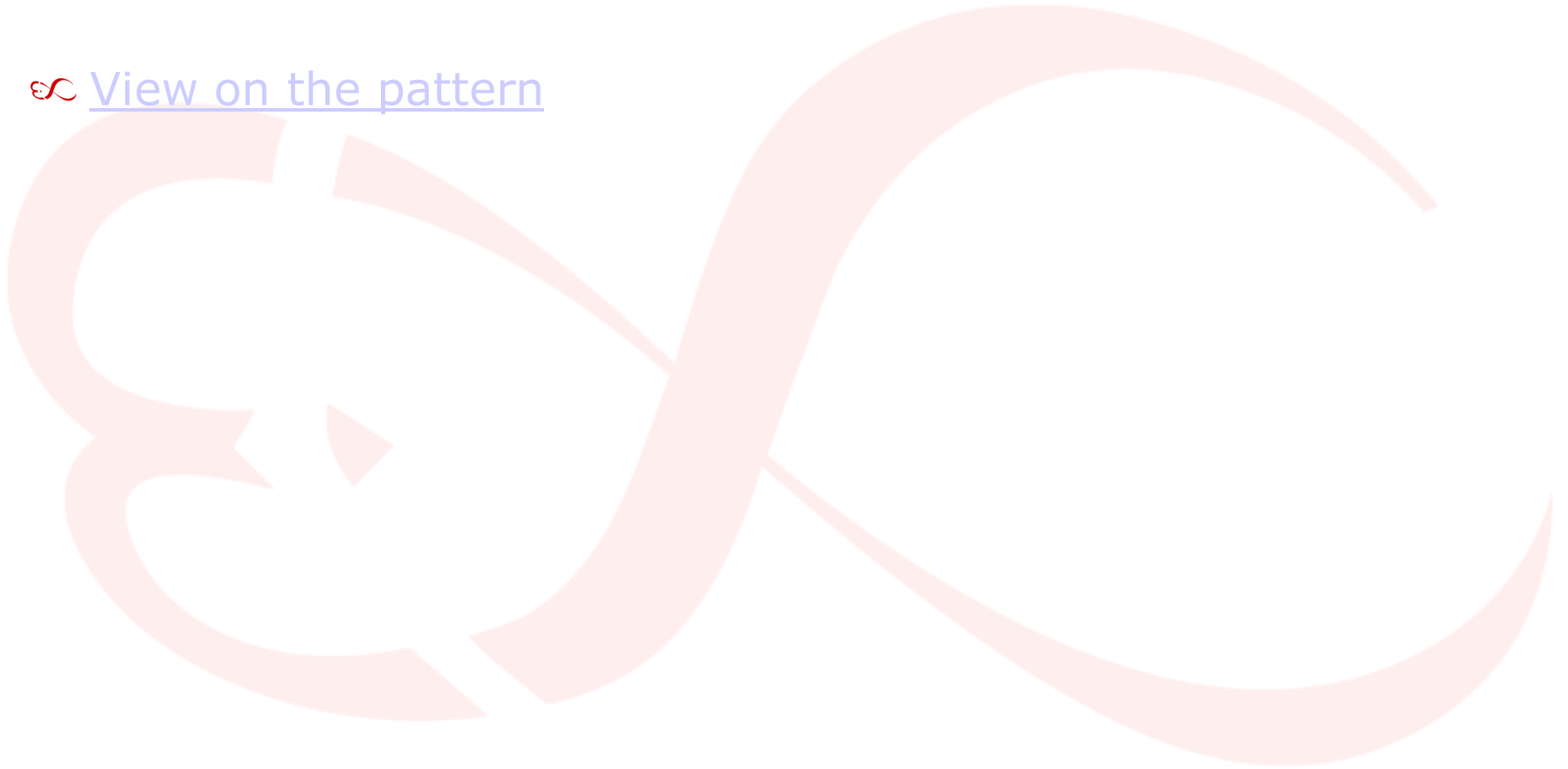



FPGF-case results: Matrix plastic strain

- ∞ We see that the matrix strain jumps at the moment it starts to break. The values correspond to what the matrix can approximately support in reality.

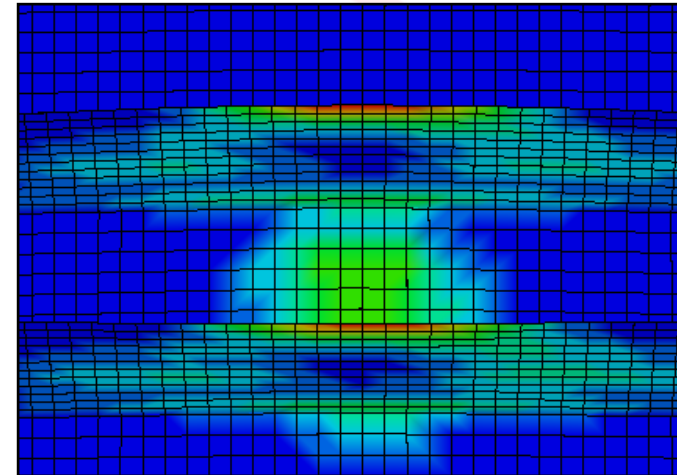
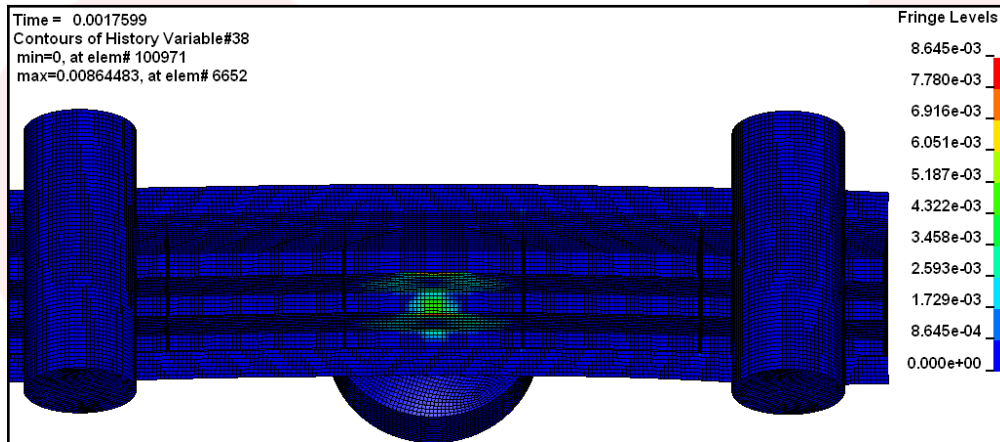

Courtesy of Rhodia

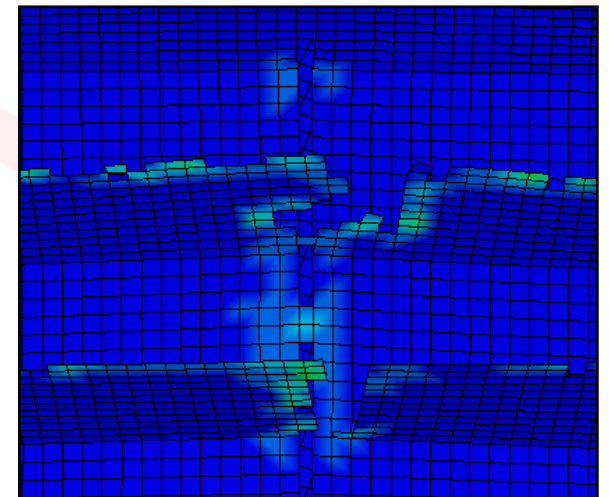
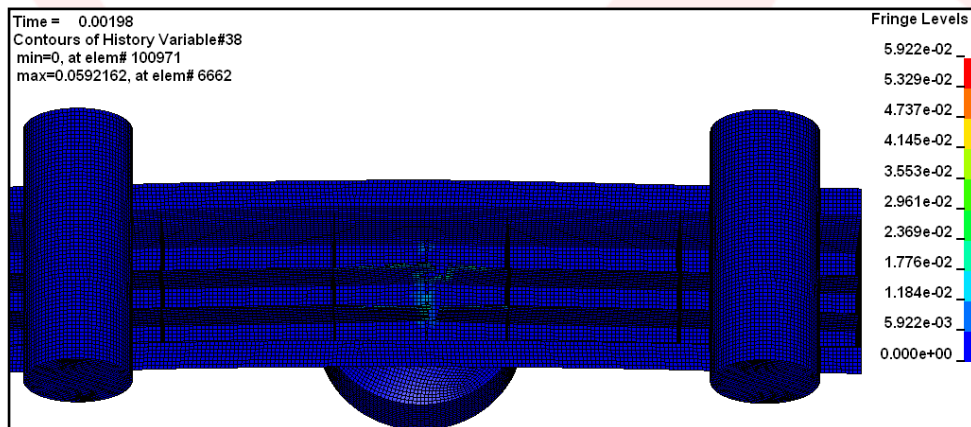



Digmat to LSDYNA now parallelized

∞ Digimat to LS-DYNA MPP is now available and the computation time is efficiently reduced:

✓ First 0.5ms of the total run presented earlier

# Procs	1	2	4	8
CPU Time (s)	13162	6986	3701	2061
Ratio	1	1.88	3.56	6.39

✓ Available on

- Linux 64bits
- Windows 64bits



Conclusions

The coupling of LS-DYNA and DIGIMAT successfully enables :

- ✓ Taking into account **local microstructure** morphology (fiber orientation, shape and content), directly within the LS-Dyna model
- ✓ Modeling and performing **nonlinear** multi-scale analyses within LS-Dyna
- ✓ Defining failure indicators at **micro** & macro scales
- ✓ Taking into account product processing conditions
- ✓ Taking into account the initial stresses relative to process

Version 3.2 of Digimat to LSDYNA enables :

- ✓ Doing parallel computation, reducing efficiently CPU times
- ✓ Using elasto-viscoplastic modeling to account for strain rate effects
- ✓ Defining failure criteria using the progressive FPGF failure model
- ✓ Defining failure criteria that are strain-rate-dependent
- ✓ Stiffness Update Delay



Last but not least...

- ∞ Thanks for your listening
- ∞ Further information at the e-Xstream's booth (1st floor)
- ∞ We hope to see you at our users meeting : 21-23 October, Nice, France!