Analysis of a single stage compressed gas launcher behaviour : from breech opening to sabot separation

F. Plassard, J. Mespoulet, P. Hereil,
Thiot-Ingenierie, Route Nationale - Puybrun F46130, France
recherche@thiot-ingenierie.com
www.thiot-ingenierie.com

Abstract

Single stage compressed gas guns are used in Shock Physics laboratory to perform characterization experiments and ballistic events. The main advantage of this kind of launcher is that impact conditions are well defined (impact obliquity, impact velocity). In order to achieve high quality in ballistic performance, it is essential to understand the behaviour of the projectile in the barrel of the gun. This paper is devoted to the simulation of the whole behaviour of a laboratory gun, from breech opening up to the muzzle blast sabot separation due to air drag forces.

LSDYNA was used as a numerical tool for the improvement of the launched package behaviour which consists in sabots and projectile. The simulation needs to reproduce the in-bore operations of a launcher taking into account gases which act on both sides of the projectile: very high pressures release at the base as well as pressure built-up and the gas thrown out from the tube at the front. There is also a need to predict perfectly the sabots behaviour when the projectile is released from the tube so as to control the impact conditions on the target.

The Fluid / Structure Interaction (FSI) capability of LSDYNA is used as a numerical tool to increase the knowledge in this field. The challenge is to obtain a simulation recreating the effect of gases on the projectile at both high pressures and high velocities. High speed and ultra high speed video cameras set up in our facility allow us to make correlation between calculations and experiments and so validate the simulation. This work gives to our Laboratory a real tool for optimizing the sabots design in terms of material, shape, dimensions and thus increases the quality and reliability of ballistic experiments.

Keywords: Compressed gas gun, FSI, projectile, sabot separation

INTRODUCTION

Thiot Ingenierie uses the single stage gas gun TITAN for shock physics experiments and ballistic tests. Most of these tests need to use a sabot to carry the impactor or the projectile during the acceleration in the barrel, but it must not disturb the impact. One solution is to have means for stopping the sabot at the muzzle of the launcher but fragments can go on due to the sabot break. Another solution is using air drag forces to open the sabot and make it away from the impact test.

The goal of this paper is to simulate an experiment of sabot opening in the air. Fluid/Structure Interaction capabilities of LsDyna are used to simulate gas flow and projectile acceleration. Ultra high speed video cameras set up in our facility during ballistic test allow us to make correlation between calculations and experiments.

First part of this paper deals with the experimental configuration and the second one shows the simulation results.

EXPERIMENTAL PROCEDURE

The sabot opening test has been realized with the 60 mm diameter type single-stage gas gun TITAN (Figure 1). This gun is composed of a 6 litres gas reservoir, a 8 meters launch tube, a first target chamber (1.2 m spherical) and a large target chamber (56 m³) used for ballistic events. To perform the sabot opening test, the coupling extension between the two target chambers has been removed and a screen paper has been used in order to better observe the flight of the sabots. This configuration is presented on Figure 2. The length between the two chambers is 3.5 meters. During the test, the sabots and the projectile speed up in the launch tube, then free-flight in the air from the muzzle of the gun to the recuperation hole, crossing the first target chamber and the free-flight zone.

The sabots are a two-piece low-density foam cylinder in which a steel cube has been arranged. The sabots and the cube are thrown out from the tube at a velocity of 95 m/s. This experiment uses a very high speed camera to capture the fly of the sabot and the projectile at a frame rate of 8000 frames per second.

Six frames selected from high speed video monitoring, are presented on Figure 4. These frames show the sabots and the projectile thrown out from the impact chamber up to the recuperation hole. The steel cube exits 4 ms before the sabots which lose its balance. The rear part of the sabots is opened when it exits from the chamber. This phenomenon can be explained by turbulences in the spherical chamber at the muzzle of the gas gun. During the free-flight, we can observe the opening of the sabots. After 3.5 meters, each sabot is totally opened and has rotated with a 90° angle. These frames show that the sabots are slowed and unbalanced by air resistance while the steel cube is properly balanced.

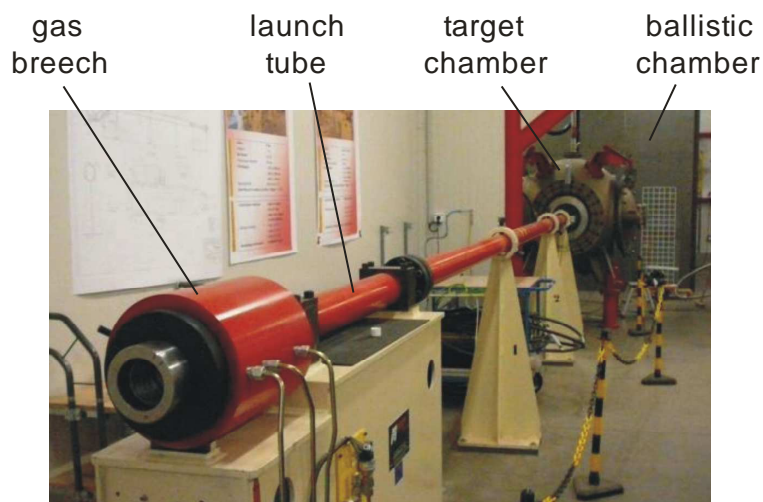

Figure 1 : Single stage gas gun TITAN

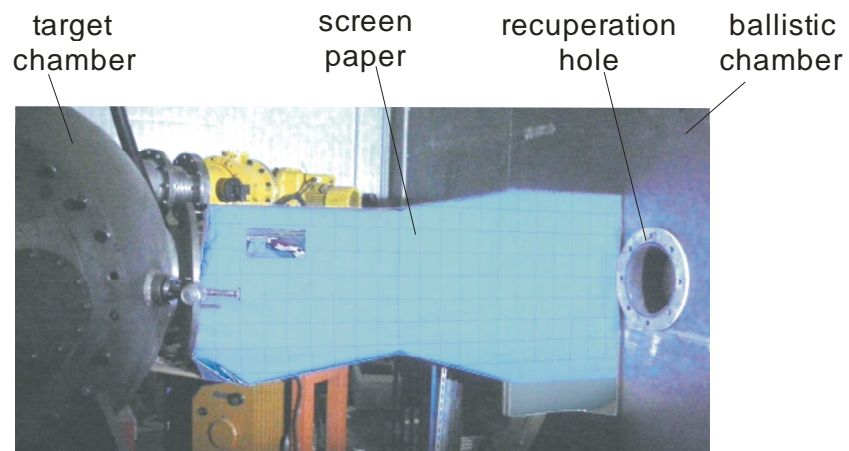

Figure 2 : Position of the free-flight zone



Figure 3 : Sabot and steel cube projectile used for the test

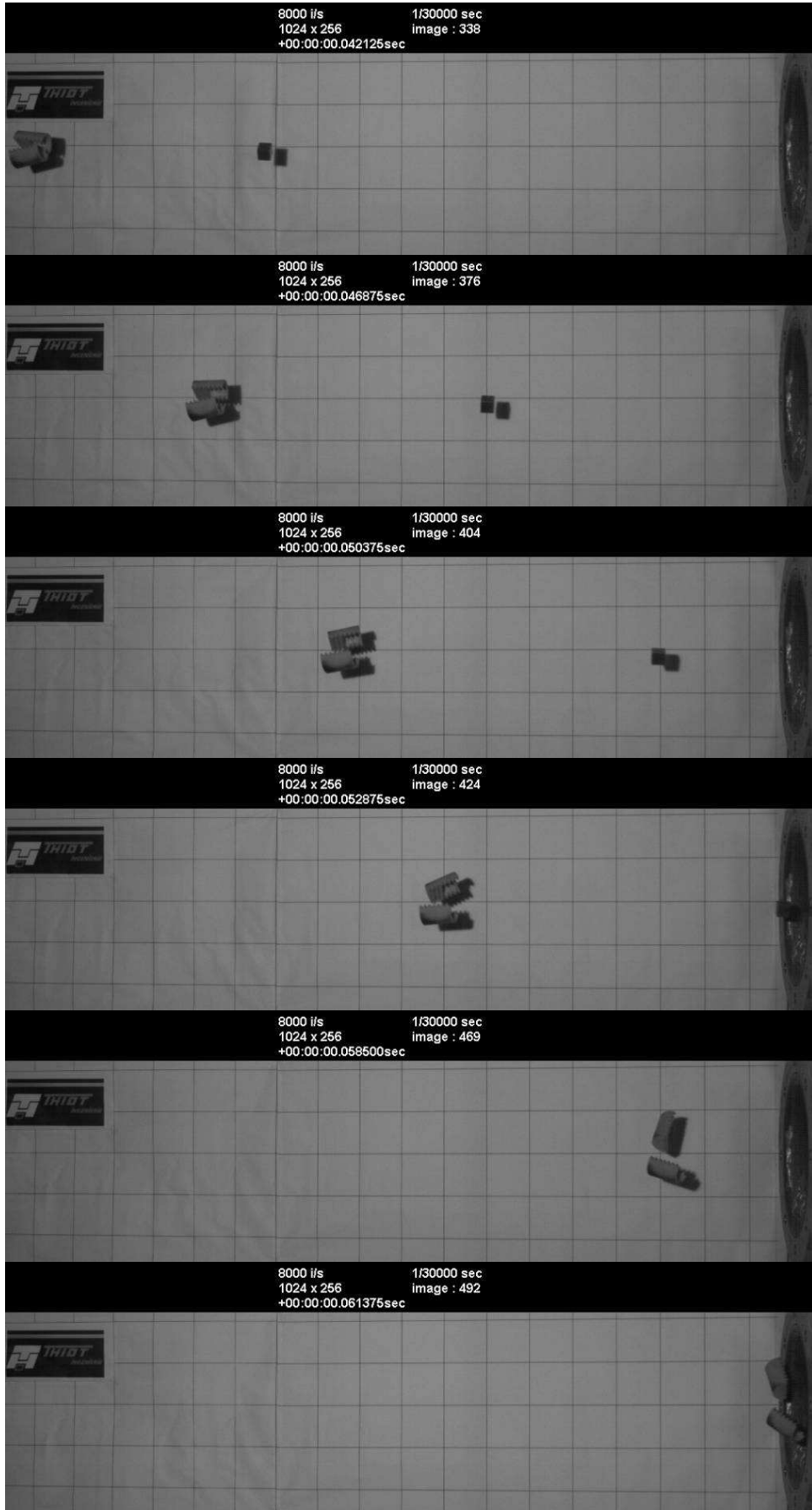

Figure 4 : High speed video of the free-flight of the sabots and the projectile

SIMULATIONS

The aim of the simulation is to use fluid/structure capabilities (FSI) to simulate the opening sabot test ([1],[2]et[3]). The gas is simulated with an Eulerian formulation and the sabot with a Lagrangian formulation. Firstly, 2D axi-symmetric calculations have been tried but the fluid/structure interaction (Lagrangian in solid) makes problems. Indeed, both high pressure of the gas and high velocity of the sabot cannot be well managed by the interface. Therefore, 3D simulations have been performed using quart-symmetry conditions.

Meshing of the configurations is presented on Figure 5 and Figure 6. High pressure reservoir has been simplified to a constant diameter section. The launch tube is fully meshing and filled with 1 bar air. All the space between the muzzle of the tube and the recuperation hole has been modelled in Eulerian formulation. The shape of the spherical impact chamber has been simplified into a cylindrical shape to simplify the meshing phase.

Simplified sabots and launch tube have been modelled in Lagrangian formulation as presented on Figure 8. Steel cube projectile is not taking into account because only the sabot is interesting for the aerodynamic behaviour.

Figure 9 represents the initial conditions for the gas reservoir. Initial pressure of helium gas is 100 bar at the rear face of the sabot. Condition on front face of the sabots is air at the atmospheric pressure. Equation of state for helium and air is perfect gas in the calculations.

The simulated configuration differs from the experimental conditions described in the previous section of this paper. The objective of this paper is not to simulate strictly the experiment but to analyse the ability of LsDyna to reproduce the physic encountered in this kind of configuration. Therefore, projectile velocity or pressure level is not the main parameter which will be compared with experiments.

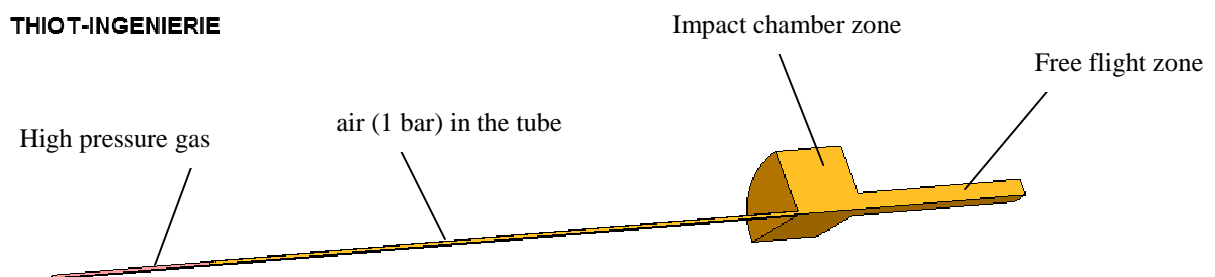

Figure 5 : Eulerian mesh

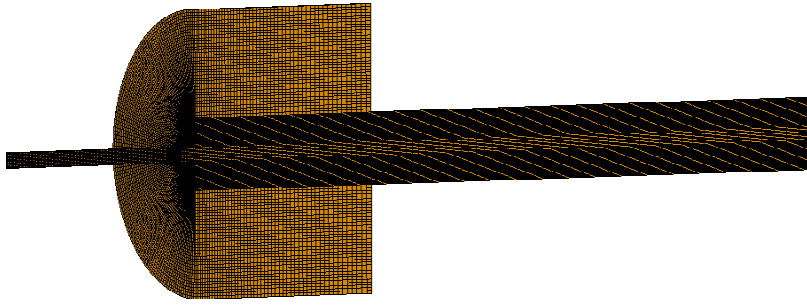

Figure 6 : Eulerian Mesh (zoom)

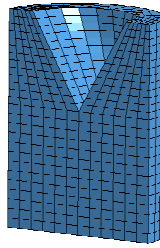

Figure 7 : Lagrangian simplified modelling of the sabot

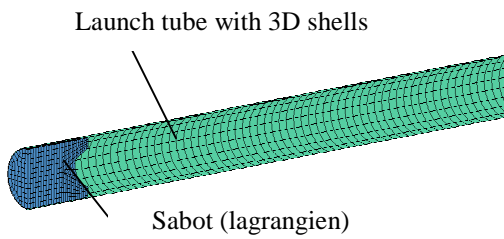

Figure 8 : Sabot in the tube

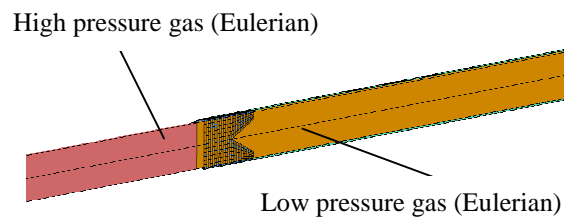

Figure 9 : Coupled fluid/structure modelisation

RESULTS AND DISCUSSION

Results of calculations which are presented Figure 10 to Figure 11, may be decomposed in two parts: acceleration of the projectile inside the tube and separation of the sabots outside the tube.

Acceleration of the projectile inside the tube shows that the evolution of the gas pressure is correctly predicted: pressure level decreases at the rear face of the projectile and increases at the front face. Another interesting result is the ability of the numerical schema to reproduce the propagation of shock wave in compressed gas. This physical effect is important for the resistance of the projectile in the tube, especially when this projectile is composed of several pieces. It is also observed the formation of a shock wave in front of the projectile, in the gas initially at atmospheric pressure.

For this internal ballistic calculation, results show that LsDyna is able to simulate the acceleration of the sabot in the launch tube with all the physic associated. With 3D models, fluid/structure interaction works without numerical leak. However, fluid/structure interaction is not easy to manage in the case of high pressure gas in contact with mobile object. Furthermore, this problem of contact is increasing when high pressure is combined with high velocity of the projectile. It has been shown that every configuration needs to be check in order to find the right parameters to manage interactions.

In the tube, gas behind the sabot is stronger but during the free-flight pressure before the sabot is higher and it causes the sabot opening.

The second part of these results which concerns external ballistic, is presented on Figure 11. These pictures represent the gas pressure around the projectile, when the projectile leaves the tube. It is shown that the expansion velocity of the gas is higher than the projectile velocity. When the projectile is in the tube, the gas pressure is higher at the back of it. When the projectile leaves the tube, the gas pressure becomes higher in front of it, which causes the sabot opening. This behaviour of the gas around the projectile is consistent with the physic.

Figure 12 shows the comparison between the different shapes of the sabots obtained by calculation and during experiment at the end of the free-flight. Calculation gives an opening angle of 30° lower than the experimental value of 80° . This can be explained by:

- The simulated sabot has not the same aerodynamic shape as the real one.
- The mesh is too coarse in this configuration. For this paper, internal and external ballistics have been studied in only one calculation in order to show both acceleration in launch tube and free-flight. Therefore it was not possible to refine the mesh without too large calculation durations. But it is possible to manage one refined model for each behaviour case

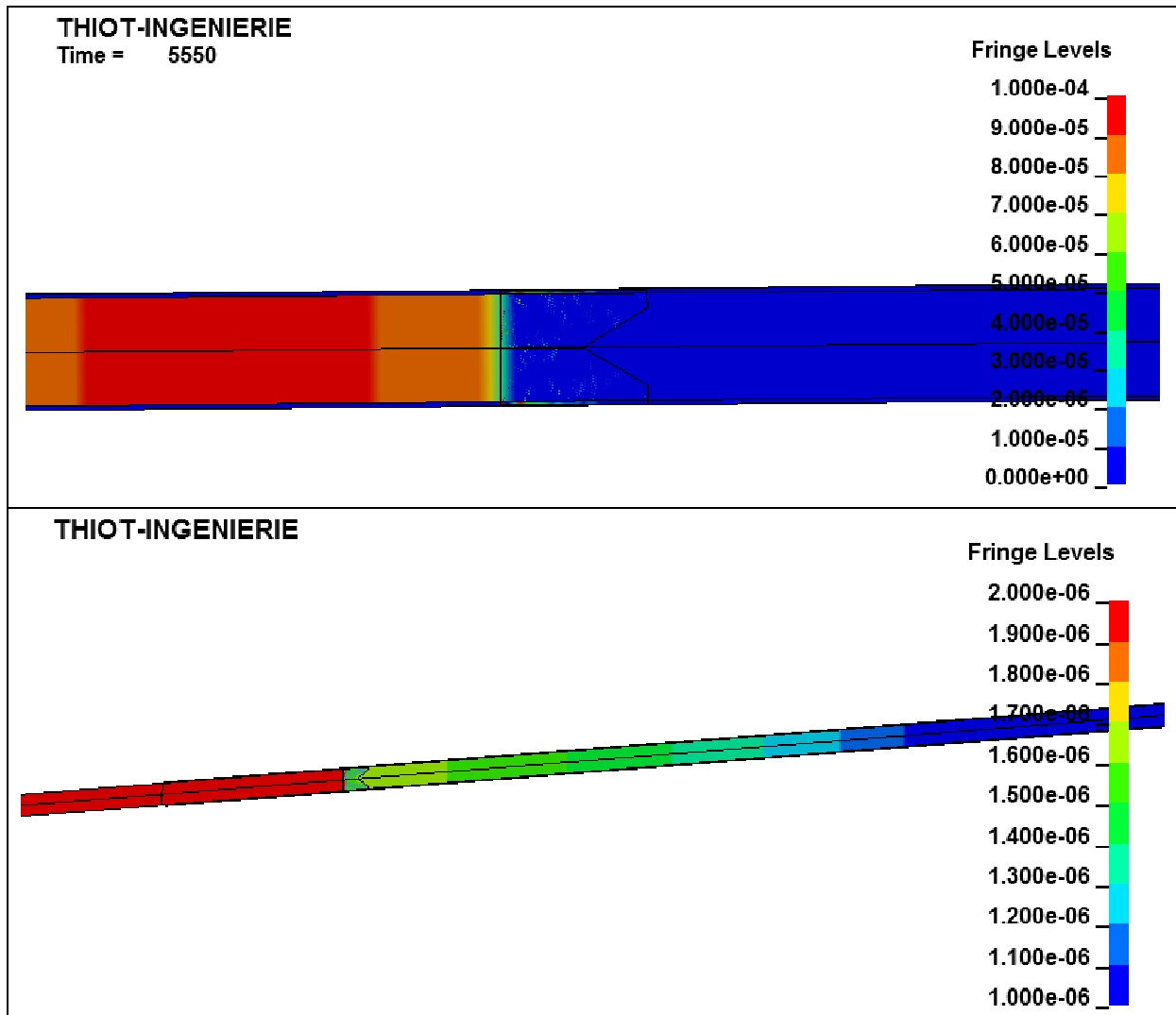

Figure 10 : Sabot acceleration in the launch tube (pressure between 0 and 100 bar)

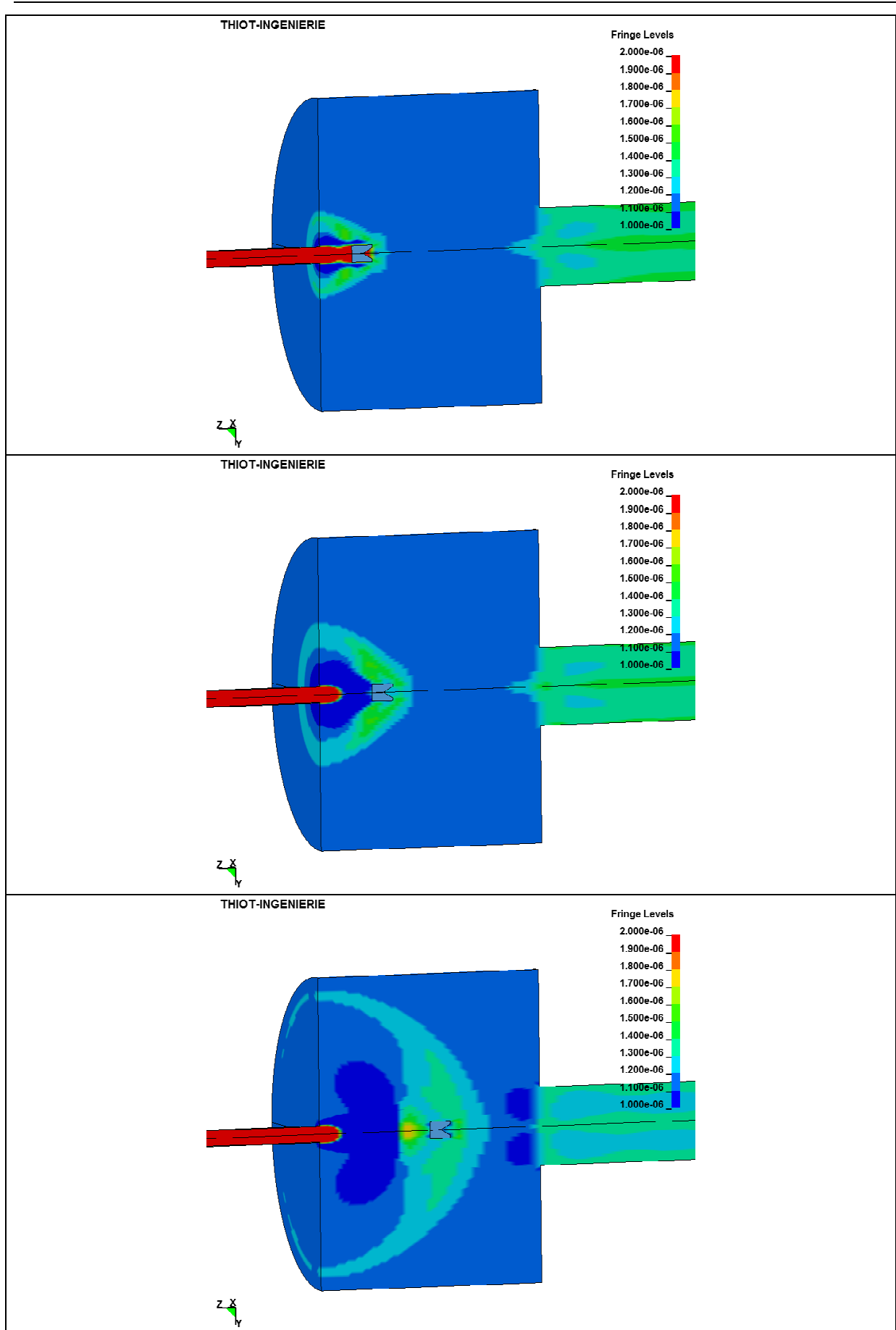

Figure 11 : Arrival in the impact chamber (pressure between 0 and 20 bar)

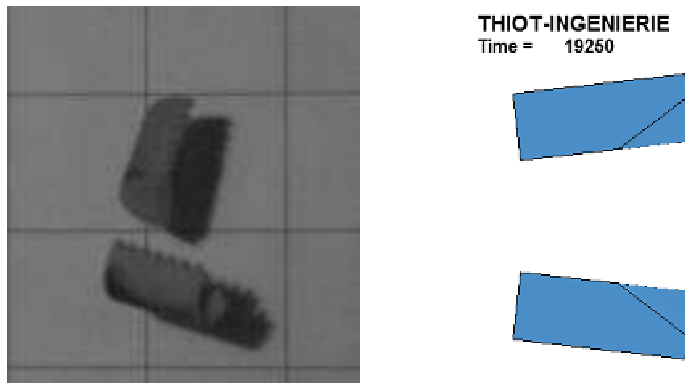

Figure 12 : Sabot opening (experiment and simulation)

CONCLUSIONS

The objective of this study was to evaluate the ability of LsDyna to simulate internal and external ballistic of a one-stage single gas gun. A fluid/structure interaction (FSI) schema has been used to calculate the evolution of a two-pieces sabot projectile in the launch tube of TITAN, a 60 mm single stage gas gun installed at Thiot Ingenierie Shock Physics Laboratory. All the calculations have been performed with a regular meshing in an eulerian space. In parallel, experimental results have been obtained with high-speed video showing the opening of the two sabots when they leave the launch tube.

From a numerical point of view it has been shown that :

- 2D axi-symmetric calculations have been tried but the fluid/structure interaction (Lagrangian in solid) makes problems : both high pressure of the gas and high velocity of the sabot cannot be well managed by the interface.
- In 3D configurations, FSI is not easy to manage in the case of high pressure gas in contact with mobile object. Furthermore, this problem of contact is increasing when high pressure is combined with the high velocity of the projectile. It has been shown that every configuration needs to be check in order to find the right parameters to manage interactions.
- Combined calculation of internal and external ballistics give a two coarse meshing for external ballistic. It would be better to calculate separately these two cases in order to refine the mesh for the last case.

From a physical point of view, the results have shown that :

- The high pressure and law pressure behaviour of the gases are well reproduced, especially with the formation of shock wave in the compressed phase as in the low pressure phase

-
- When the projectile leaves the launch tube, the kinematics of the gases in the target chamber is responsible for the pressure gradient around the projectile. This causes the opening of the sabot at the beginning of the free-flight area.
 - During the free-flight, air force drag gives the complete sabot separation.

This study which combines experimental high technology and simulations, have confirmed the ability of LsDyna to calculate internal and external ballistics of a single stage gas gun. Our objective was not to check the velocity value or the pressure value during the test but rather to focus on the physics encountered in this test. From this point of view, FSI gives interesting results.

For future works, free-flight zone and sabot shape has to be refined in order to improve the experiment/calculation correlations and to be able to design sabots for specific applications with calculation capabilities.

The other planned work, which is in fact the final objective of these preliminary calculations, is to use LsDyna FSI capabilities to simulate the whole behaviour of the two stage light gas gun HERMES, installed at Thiot Ingenierie Shock Physics Laboratory. In this experimental device, pressures of some kbar and velocities of some km/s are present. Therefore fluid/structure interaction management will be one of the main problem. Another difficulty concerns the EOS of the gases with very large pressure and temperature values. An ideal gas law is not enough consistent for these applications.

ACKNOWLEDGEMENT

The authors would like to thank V. Berger and G. Darnis for their essential technical contribution during the realization of these experiments.

REFERENCES

- [1] Todd P. Slavic "A coupling of Emperical Explosive Blast Loads to ALE Air Domains in LS-DYNA" *7th European LS-DYNA Conference*.
- [2] A. Neuberger, S.Peles, D. Rittel "Scaling the response of circular plates subjected to large and close-range spherical explosions. Part II : Buried charges" *Intenational Journal of Impact Engineering 34 (2007) 874-882*.
- [3] A. Neuberger, S.Peles, D. Rittel "Springback of circular clamped armor steel plates subjected to spherical air-blast loading" *Journal of Impact Engineering*.